

**PC**

# PowerPlay

PC GAMES & TECHNOLOGY.  
100% AUSTRALIAN



FW 36  
\$ 8.95

**BATHURST SIM! FIRST LOOK**



**REVIEWED**

# HEAVY GEAR 2

HEAVY DUTY MECH WARFARE



**next gaming**  
ISSUE 40 SEPTEMBER 1999  
\$8.95 NZ \$12.95 inc. GST  
40  
9 771326 156402

**AWESOME REVIEWS**  
MIDTOWN MADNESS  
MIGHT & MAGIC VII  
SPORTS CAR GT  
F22 LIGHTNING 3  
OUTCAST

**REVIEWED**

# TOTAL ANNIHILATION: KINGDOMS

Medieval Masterpiece or Fantasy Flop?

**HUGE PREVIEWS**



# VAMPIRE HOMEWORLD GIANTS

SYSTEM SHOCK 2

**HERCULES TNT2 ULTRA**  
King of 3D Cards

**ON THE CD**



# BRAVEHEART

STAR WARS EP.1: RACER, REVOLT, DRAKAN  
NO CD? PLEASE ASK YOUR NEWSAGENT



**ATHLON CPU**  
AMD's Pentium Killer

THE RACE BEGINS. YOUR PRIZE AWAITS.  
GIVE IT SOME DOWN THE STRAIGHTS.  
TAKE CORNERS AS FAST AS YOU CAN.  
LOOK OVER YOUR SHOULDER TO ENSURE  
YOU ARE CLEAR FROM THE REST OF THE FIELD.  
THE FINISH - AND GLORY ARE IN SIGHT.  
ONCE YOU REACH THE SHOP,  
ASK FOR CHS 2000.



exclusively distributed by:



[www.metrogames.com.au](http://www.metrogames.com.au)

The most realistic Motorcycle simulation ever made for the PC

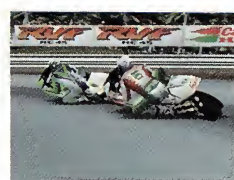

# Explore



From in-depth character profiles to cinematic secrets, this is the CD-ROM that unearths what it takes to build a universe.

## STAR WARS EPISODE I INSIDER'S GUIDE



RATING PENDING  
**RP**  
ENTERTAINMENT WEEKLY  
RATING BOARD





A killer is coming, walking between worlds...  
trailing death from Liveside to Deadside.

A dead man is coming, skull in one hand, gun in the other...  
a voodoo mask in his chest and lines  
of power in his back.

A possessed man is coming, stalking killers  
in tenements and deserts,  
subways and swamps, spirit world and real world.

Shadow Man is coming.

Voodoo slave and hero.

Hitman and deadman.

Sometimes,  
it takes a killer to stop a killer.

# SHADOW MAN™

after dying...  
killing is easy.



Shadow Man™ & © 1998 Acclaim Entertainment Inc. All Rights Reserved. Acclaim is a division of Acclaim Entertainment, Inc. © and © 1998 Acclaim Entertainment, Inc. All Rights Reserved. Developed by Iguana Entertainment Ltd., an Acclaim Entertainment studio. Marketed by Acclaim. Distributed by Acclaim Distribution, Inc., One Acclaim Plaza, Glen Cove, NY 11542-2777. All other trademarks are the properties of their respective companies. LICENSED BY NINTENDO. NINTENDO, THE OFFICIAL SEAL, NINTENDO 64 AND THE 3-D "N" LOGO ARE TRADEMARKS OF NINTENDO OF AMERICA INC. © 1996 NINTENDO OF AMERICA INC. PLAYSTATION AND THE PLAYSTATION LOGOS ARE REGISTERED TRADEMARKS OF SONY COMPUTER ENTERTAINMENT INC.

# CONTENTS

ISSUE 40  
SEPTEMBER  
1999

**Editorial** 9  
Inside the games biz and behind the scenes with the bloke who makes like he actually knows.

**CD Guide** 10  
Where to put it, what button to press and a few basics on playing all the red hot games on this month's CD.

**News** 14  
S3 buys Diamond and we all reel with shock but then realise it probably doesn't matter at all, Bathurst sim, Xatrix explain Kingpin, the latest on Grand Prix 3 and TONS MORE!

**SUBSCRIBE** 18  
Join Club PowerPlay and be in the running to win a funky Kodak digital camera. What you do with the prize is entirely up to you.

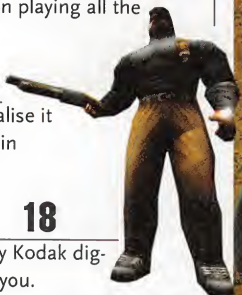

## HOTWARE

**Hotware** 22  
Tested: The Dell Pentium III 550. We give new control pads the full workover, plus, get to grips with a sexy new digital French joystick, and we test the fastest 3D graphics card ever - the magic Hercules TNT2 Ultra.

**The Cable Modem** 26  
Seeking the ultimate in online gaming speed, we hook up with cable tech and rabbit on a bit about how amazing it all is.

**Window Dressing** 28  
Who wants to spend their computing time looking at the standard Windows desktop? Boring people with no taste, that's who! Fix it forever with our handy Windows Makeover Guide.

**State of Play** 34  
The distilled essence of the next step in gaming.

## PREVIEWS

System Shock 2	36
Giants	38
Messiah	39
Planescape Torment	40
Star Trek: Starfleet Command	42
Star Trek: New Worlds	42
Star Trek: Klingon Academy	43
Desert Fighters	44
Urban Chaos	46

Abomination: The Nemesis Project	46
Tachyon: The Fringe	48
Odium	48
Imperium Galactica 2	49
Vampire: The Masquerade	50
Atlantis II	52
Castrol Honda Superbikes 2	54
USAF Fighters	56
Homeworld	53

## REVIEWS

The List	60
Review Contents	63

Total Annihilation: Kingdoms	64
Heavy Gear 2	68
Midtown Madness	72
Sports Car GT	78
Mike Stewart's Pro Bodyboarding	80
Outcast	82
Saga: Rage of the Vikings	84
F-22 Lightning III	86
Corsairs	88
Might and Magic VII	90
Anno 1602	94
Man of War 2	96



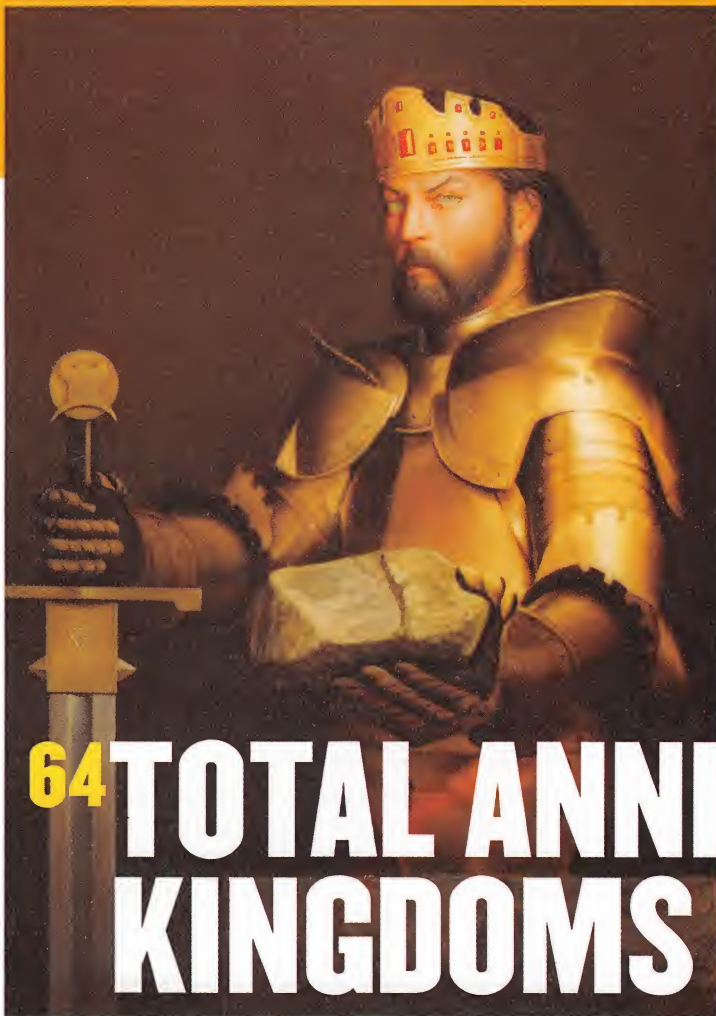

# 64 TOTAL ANNIHILATION: KINGDOMS



**68 HEAVY GEAR 2** **98**  
Retroversion  
Total Annihilation

## Diversions

**Episode 1: Insider's Guide** **100**  
Star Wars - it's big. We contribute a small log to fuel the global inferno of hype.

## Gameplay

**Oracle** **102**  
What the Oracle doesn't know about games can be writ small on the head of a pin. The Oracle has a pinhead too, FTR.

**Tips and Tactics** **104**  
Little bits of incredibly useful game help.

**Code** **105**  
Cheat codes for honourless cretins.

**Playguide: Starsiege: Tribes** **106**  
Kick some online butt with the special skills our playguide imparts.

**Playguide: Heroes of Might & Magic III** **114**  
Made it through to about half-way, only to hit the 'too hard' wall? So did the bloke who wrote this playguide, but we kept whipping and he kept playing.

**QuakeNews** **120**  
There's no game quite like Quake/Quake 2, that's why it gets its very own news section. Impressive huh?

## TECH

**Setup** **124**  
Doc Ash imparts his mighty wisdom to help with the techy grief that's getting you down.

**Graphics Tech** **128**  
AMD's K7 'Athlon' could be the CPU that breaks Intel's back, we also look at Intel's comeback - their P3 600MHz - is it worth the big \$'s?



## Online

**Net Game News** **133**  
Like a web page, but on paper and not quite as interactive.

**Webstalk** **137**  
Hot sites for when you're bored mindless.

**Letters** **138**  
What readers wrote.

**Read Error** **141**  
Empty your mind and bask in the carefree irreverence of the Silly Page.

## Flashback Special

**LucasArts Adventure Games** **142**  
Fanatically, followers of LucasArts adventure games swear they are the best ever. And they are, John Dewhurst looks back at the timeline of gaming history.

**Competitions** **146**  
Win stuff that you'd ordinarily have to buy.

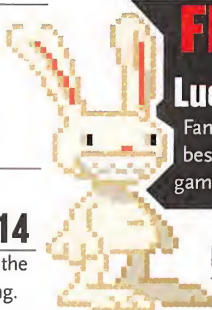

For the superior system  
Put **Intel Inside®** and  
**ViewSonic® on top!**



**(PC Sold Separately)**

**Turn traditional thinking on its ear.**

Today, regardless of the PC brand you choose, the most important component is not the computer. It's the monitor. Yesterday, the hot phrase was "Monitor Sold Separately." Today, it's "PC Sold Separately." Technology blurs the lines between one computer and another. They're all fast, all loaded, all pretty much the same.

What's different, what's exciting is happening in displays - multimedia monitors with built-in teleconferencing capabilities and monitors with short depth technology that will save you a lot of space.

ViewSonic PS775 is a real space saver with a footprint comparable to most 14" (various viewable) monitors. With spectacular specs like 0.22mm horizontal dot pitch, a resolution of 1280 x 1024 at 90 Hz flicker-free refresh rate and SuperClear™ screen technology, it provides high-contrast, strong, bright color images. With the USB hub base, it allows users to incorporate up to four additional USB compliant peripherals for multimedia.

At ViewSonic, we developed the PS775 for anyone looking for high performance suited to a compact environment. It's TCO'95 certified. By putting ViewSonic PS775 on top of your priority list, you'll ensure your Visual Computing™ experience is guaranteed to be excellent.

For more information call ViewSonic at  
Asia Pacific Sales: Tel:886-2-2248-4072, Fax:886-2-2240-8238

Copyright ©1999 ViewSonic Corporation, all rights reserved. Corporate names and trademarks stated herein are the property of their respective companies. Intel and the Intel Inside logo are registered trademark of Intel.



[www.viewsonic.com](http://www.viewsonic.com)



Publisher: Phillip Keir  
*keir@next.com.au*  
Editor: Ben Mansill  
*ben@next.com.au*  
Deputy Editor: March Stepnik  
*march@next.com.au*  
Staff Writer: David Wildgoose  
*david@next.com.au*  
Art Director: Malcolm Campbell  
*malcolm@next.com.au*  
CD Editor: Harry Maragos  
*cdtech@pcpowerplay.next.com.au*  
Contributors: Ed Dawson, Maj. Ian Lindgren, Rod Campbell, Brett Robinson, Ashton Mills, John Dewhurst, Elih Brading, Agata Budinska, Jhar, Hugh Norton-Smith, Phill Bennett  
Technical editor: Garry Wallis  
US Correspondant: Don St. John  
UK Correspondant: Steve K. Boxer  
Photographer: Scott Wajon  
General Enquiries: (02) 9699 0333  
Fax: (02) 9310 1315

## ADVERTISING

National Sales Director: Steve Watson  
*steve@next.com.au*  
Advertising Manager: Julie-Ann Kwok  
*julie@next.com.au*  
Production Co-ordinator: Emma Beck  
*emma@next.com.au*  
Production Manager: Melissa Doyle  
*melissa@next.com.au*  
Financial Director: John Mullins  
*johnm@next.com.au*  
SUBSCRIPTION ENQUIRIES:  
Phone: (02) 9699 0319  
e-mail: *subs@next.com.au*  
Fax: 02 9699 0344

All copyrights reserved by  
Next Publishing Pty Ltd  
ACN No 002 647 645  
Printed by Wilke Colour  
Film produced by Prestige Colour  
Distributed by Gordon & Gotch  
Customer Service: Ph 1300 65 0666  
Fax 1300 65 0777  
ISSN: PCPP 1326-5644

Write to PC PowerPlay at:  
78 Renwick St, Redfern,  
NSW 2016, Australia  
E-mail: *pcpowerplay@next.com.au*  
Fax: 02 9310 1315  
CD tech support:  
*cdtech@pcpowerplay.next.com.au*  
Oracle: *oracle@pcpowerplay.next.com.au*  
Setup: *setup@pcpowerplay.next.com.au*  
Letters: *lettars@pcpowerplay.next.com.au*

## What we're playing:

Ben: Toca 2, Kingpin, Civ: Test of Time, C'mon Kids.  
March: Tales of the Sword Coast, System Shock 2, AvP, silly buggers 2, Chemical Brothers.  
David: System Shock 2, AvP, Beneath a Steel Sky, Magoo.  
Malcolm: Quake3ArenaTest, Joey Beltram,  
CJ Bolland, Chemical Brothers.

# Back to the Bad Old Days



Well here's a new one. The TA: Kingdoms manual warns that running with hardware acceleration mode on may degrade the performance of the game. Huh? Using your spanky new Voodoo 3 or TNT2 can slow the game down? What the hey?

It's true. 3D cards are designed to move relatively few large polygons around. TA: Kingdoms asks your card to shift large numbers of very small polys around the screen. While certain cards may not exhibit this nasty symptom, none of this is a surprise in a Cavedog game.

This lot are the new Origin. Many years ago, Origin games would only run well if one: A. Possessed the fastest PC on the planet, and B. Turned the graphics options right down to minimum. Origin's Strike Commander was by far the worst offender of the 486 era, when this curious design philosophy prevailed.

Then, along came Pentiums and 3dfx cards, and overnight this most evil of game woes disappeared for almost 2 years.

Total Annihilation and Dark Reign, both advanced RTS games, were released at virtually the same time. On a reasonable machine Dark Reign ran beautifully, while TA chugged. But we put up with that. The gameplay in TA was so wonderful that we happily ran in lower resolutions than we would expect, simply to be able to play this stunner of a game - dismissing the need for PC speed at the time as a momentary aberration.

Now Cavedog have shipped TA: Kingdoms, and for only the second time in a full two years there is a game that runs much slower than it reasonably should. On a P2400 with a 32Mb Hercules TNT2 Ultra and 192Mb of system RAM, this game jerks as it scrolls, and slows to a

horrible crawl when multiplayer gaming reaches the busy stage. To make it playable, it is necessary to turn off hardware acceleration, slide the detail right back and play in 640 x 480 resolution, with its accompanied minute field of view. The pain of having to do this when the resolution slider runs up to a full 1600 x 1200 is depressing. 1600 x 1200 works just fine for most 3D games on the same machine - so why can't it handle a slab of 2D terrain being moved around at a comparatively slower pace?

Cavedog have had 2 years to tune their game engine for performance, while over the same period CPU and graphics card capability has dramatically increased. Their new game clearly does not run any smoother as a result. This is disappointing to shameful - depending on what sort of machine you're sporting, and whether or not you'll actually bother with this game. Let's just hope it's another momentary aberration...

## Ben Mansill Editor



Total Annihilation: Kingdoms

# CD #40

The original dose of Gaming Goodness™. Beware of Imitations

## Starting the PC PowerPlay CD

Welcome to the PCPowerPlay double cover CD. We have included all the popular programs to make the most of your PC. Using the CD is easy. Simply insert the CD into your CDROM drive and it should automatically bring up the Menu interface. (If not, don't panic, just click on the RUNME.BAT file to manually install the program).

Once the menu is up, you can navigate the screens using your mouse. Click on the category of your choice (eg Education, Fun, Games, etc..) to begin. Have a look at the programs, and if you see something you like to try out, just click on it. Depending on your choice, the program will either install itself to the hard drive or run straight off the CD.

**cdtech@powerplay.next.com.au**

Faulty CDs will be replaced free of charge. Send it, together with a description of the error, to:

**PC PowerPlay CD Returns**

**Reply Paid 634**

**78 Renwick St**

**Redfern NSW 2016 (No postage required)**

## The Games



# Braveheart

**Publisher:** Eidos Interactive

**Genre:** Strategy

**Need:** P166, 32MB, SVGA 2MB

**Want:** P233, 64MB, 3D Card

Follow in the footsteps of Scottish hero William Wallace, taking on the might of the English army to gain freedom! Braveheart combines real-time strategy with global management in a brutal re-enactment of the war between sword-wielding Scottish clansman and expansionist English forces. With the latest 3D engine and state-of-the-art motion capture technology Braveheart delivers unparalleled combat realism.



### Breakneck

**Publisher:** THQ

**Genre:** Driving Simulation

**Need:** P133, 24MB, SVGA

**Want:** P233, 64MB, 3D Card

With over 40 vehicles to select from and 24 different tracks on which to race. BreakNeck is the Ultimate PC racer. BreakNeck is also visually stunning and races take part in all weather conditions on circuits from all around the world. However, Readers BEWARE there is another more darker side to Breakneck, if you by chance you keep losing your races, the game offers the chance to use weapons to blast the opposition of the track, so select your car select your track and let's race!



### Drakan: Order Of The Flame

**Publisher:** Psynosis

**Genre:** Adventure

**Need:** P166, 16MB, SVGA

**Want:** P233, 32MB, SVGA 2MB

This is Drakan: Order of the Flame, an action-adventure that seamlessly blends aerial and ground-based gameplay in a beautiful 3D world. As the player, you are Rynn, a warrior-heroine with a savvy attitude and a quick sword arm who teams up with a powerful, fire-breathing dragon named Arokh. Leaving her small village behind, Rynn and Arokh embark on an epic journey across the massive and dangerous world of Drakan in a desperate quest to save Rynn's





kidnapped younger brother - and quite possibly all of Drakan - from a fate worse than death.

## Jack Nicklaus 6: Golden Bear Challenge

**Publisher:** Activision  
**Genre:** Sports - Golf  
**Need:** P166, 32MB, SVGA  
**Want:** P233, 64MB, SVGA 2MB  
 Jack Nicklaus, decades-long

domination of the sport has made his name synonymous with golf. His achievements, an inspiration to golfers everywhere. Most Major Championship victories. Most Masters victories. Most U.S. Open victories. Most PGA Championship victories. Now you can be a part of the Nicklaus legend. For the first



## STAR WARS: EPISODE 1 PHANTOM MENACE

**Publisher:** LucasArts  
**Genre:** Adventure  
**Need:** P200, 32MB, 3D Card  
**Want:** P266, 64MB, 3D Card

Step into the epic saga from the Star Wars: Episode I story - and beyond - while taking on the roles of Obi-Wan Kenobi, Qui-Gon Jinn, Queen Amidala and Captain Panaka. Use the Force, and your wits, to overcome challenges at every turn as you plunge deeper into this story of a galaxy in crisis.



time ever, play either as, or against, the Golden Bear himself.

Feel what it's like to be a legend. Jack Nicklaus 6: Golden Bear Challenge takes the critically acclaimed game franchise to the next level, with enhanced graphics and game play, life-like golfers, an improved, intuitive interface, great camera control, excellent opponent A.I, pro-sports-caster commentary and multiplayer support.

## Mr Boom

**Publisher:** Remdy  
**Genre:** Board/Puzzle  
**Need:** P75, 8MB, SVGA  
**Want:** P100, 16MB, SVGA

MrBoom is a multiplayer free-ware game, made for DOS but that also works perfectly in w95/98. This is a clone of the famous game called Bomberman (a PC version was also named Dynablast) It's an old styled arcade game where you drop bombs. It can be played with up to 8 players, using an IPX network. Give it a try!

## Microsoft Pandora's Box

**Publisher:** Microsoft  
**Genre:** Board/Puzzle  
**Need:** P100, 16MB, SVGA  
**Want:** P166, 32MB, SVGA 2MB

A box is opened. Pieces fly away. And seven mythical Tricksters escape to wreak havoc on the world. Welcome to Microsoft Pandora's Box, a puzzle-solving game that will take you literally to the ends of the earth. This visually stunning journey includes some of the most beautiful puzzles ever created. It's up to you to solve them, capture the Tricksters, and save the world from chaos.



## Re-Volt

**Publisher:** Acclaim  
**Genre:** Driving Sim  
**Need:** P200, 32MB, SVGA 2MB  
**Want:** P2-266, 64MB, SVGA, 3D Card

Acclaim's Remote Control car racing game takes the racing genre and turns it on its head. Where you couldn't go before, there are now no limits. The





## STAR WARS: EPISODE 1 RACER

**Publisher:** LucasArts  
**Genre:** Racing Simulator  
**Need:** P166, 32MB, SVGA, 3D Card  
**Want:** P233, 32MB, SVGA, 3D Card

Climb on, strap in and experience the pure adrenaline-pumping excitement of the Podracing sequence from Star Wars: Episode I The Phantom Menace. Take the controls as Jedi-to-be Anakin Skywalker, or any one of over 20 Podracers, and feel the full-force blast of two massive jet engines at simulated speeds of up to 600 mph. Rein in a turbine-driven chariot through 8 spectacular worlds. Negotiate through flaming methane lakes, Tusken Raider assaults, anti-gravity tunnels and much more in a pulse-pounding, do-or-die fight to the finish where anyone will do anything to cross the finish line. How far will you go?



robust vehicles tumble around all kinds of locations, impossible to break, using whatever tactics necessary to gain first place in the race.

### Star Wars: Episode 1 The Gungan Frontier

**Publisher:** LucasArts  
**Genre:** Real Time Strategy  
**Need:** P166, 32MB, SVGA  
**Want:** P233, 64MB, SVGA

In this first ever Star Wars simulation designed for players age 9 and up, your goal is to transform the barren moon of Naboo into a thriving, balanced ecosystem and help the Gungans build a new underwater bubble city. From your transport ship, you control the release of Star Wars creatures and exotic plants into the empty landscape. Creatures move and interact in life-like, 3D animation and digital sounds. Monitor population levels, manage the food web, consult your online encyclopedia, and harvest valuable resources that can be used to build the new Gungan city.

### Warhammer 40000: Rites Of War

**Publisher:** SSI  
**Genre:** Strategy  
**Need:** P200, 64MB, SVGA 2MB  
**Want:** P266, 128MB, SVGA 4MB

The time has come for the Eldar, minions of a dying race, to re-secure their secrets from the hands of the lesser beings. As the working leader of the dwindling Eldar forces, you are put to the task of accomplishing your waning culture's next stand. Combining the accessible turn-based style of Panzer General II with the gorgeous and horrifying imagery of the battle-torn WarHammer 40K universe, Rites of War brings you a strategic challenge that will blow your mind. 40K figures fully animate as they move, attack, and die.

Your warriors mature and strengthen along the path of your choice, so the pain of battle makes itself known with every loss. Units can learn Psyker powers, employ artifacts and gain special abilities, if they survive. Tacticians who remember Fantasy General will feel at home in this world where storming ancient ruins can reveal powerful artifacts, unit enhancements and powerful allies. But beware, often bounty keeps company with peril letting death turn tomorrow's greatest hero into the Craftworld's next spirit stone. Join in the epic struggle of this Eldar confrontation and throw yourself into an animated saga that pits your wits against a hostile cosmos!



# Utilities & Patches

## 3D FTP

3D-FTP is an FTP client with a 3D, photo-realistic user interface. This interface is fully customizable through the use of skins, (check the UTILS\3DFTP folder for more skins) 3D-FTP also has a robust and fast FTP engine with many standard features, including the ability to resume file transfers.

## Diji Album

The Diji Album Editor is a tool that allows you to create electronic photo albums. In other words, it allows you to recreate all the enjoyment you experienced when putting together your real photo albums, but on your computer instead.

## EFX

eFX is a small, fast window changer for Windows 95/98/NT. It lets you change the look of all your windows via easy to make skins. You can use any of the many pre-made skins or you can make your own, it's not hard at all. Setup is achieved via the eFX control panel. You simply double click the icon in your system tray and change options on the fly including your current skin. For more info check page 28 in the mag.

## Icon Packager

One of the most versatile, and powerful, yet easy to use shell customisation programs available. IconPackager allows you to customise features in Windows 95, 98 and Windows NT 4.0 that are not accessible from the standard user interface. Some of these features may improve system performance, some may make your life with Windows a little easier, and others are purely cosmetic. Several features of IconPackager make it stand head

and shoulders above most other customisation programs that are currently available.

IconPackager provides you with the capability to replace any shell icon on your system. As you have probably found out, these icons cannot normally be changed. The tabs within the program associate the icons, with the area that is affected when replacing a file. The graphics on the different tabs show you their true size, as they are displayed on your system.

## K-Jöfol

K-Jöfol is an MP3, VQF and AAC player that supports Winamp DSP and Output plugins. Much attention has been paid to the design of K-Jöfol, creating a look that is both functional and attractive. K-Jöfol offers support for skins and plug-ins and mIRC, and features pitch and volume knobs as well as a graphic equalizer.

## LiteStep

LiteStep is a customizable shell replacement for Windows 95/98/NT. You can completely alter the look of the program, modifying its graphics, clock, miniature applications, and so on. This idea is based on the NextStep operating system and the AfterStep Linux window manager. There is also a virtual desktop feature, allowing you to increase productivity and workspace. LiteStep allocates six to six times less memory than Explorer (Shell) and is friendly on CPU usage.

## Macromedia Flash 4

Flash is the standard for interactive vector graphics and animation for the web. Web designers use Flash to create beautiful,

## Windows Blinds

WindowBlinds is a utility that will change the way you look at Windows. It allows you to completely customize your desktop by changing the style of title bars, buttons, and toolbars. You can change the look of buttons and check boxes by assigning them skins, or personalities, and you can assign buttons to toolbars that will launch programs. You can create your own skins, choose from the four that are included in the program, or download additional ones. You can also choose to exclude certain programs from WindowBlinds if you don't want to change their appearance.

resizable, and extremely compact navigation interfaces, technical illustrations, long-form animations, and other dazzling effects for their site. Graphics and animation will anti-alias and scale based on the viewer's screen size, providing high-quality viewing. Flash advances web animation with exciting transparency and shape blending effects. New movie clip and button actions create sophisticated interactivity without scripting. Improved interface design and functionality make Flash easier to use and more productive than ever.

## Reveal

Reveal is a desktop shell written to be used as your windows shell. It makes it possible for you to launch all your programs from it, as well as manipulate your programs and run various plug-ins to enhance the desktop

## Smart Pix Manager

Smart Pix Manager is a complete system for managing and viewing images. Built on a relational database, the program lets you assign multiple attributes (that is, keywords or descriptions) to images in your collection, allowing you to easily search and/or categorize your images. The program supports a range of image formats, including JPEG, GIF, BMP, PCX, WMF, EMF, ICO, DIB, and RLE files.



## Sonique

Sonique is an audio player capable of handling MP3 files, Microsoft Windows Media files, audio CDs, and more. It features a dynamic, windowless interface, complete with fully animated menu systems. Additional functionality includes a full-featured playlist editor, a variety of unique output visualization modes, plug-ins, a robust control set featuring pitch, jog and shuttle, a balance and amplification adjustment, and more...

## Talisman

Talisman is a shell for Windows that hides the standard desktop. In the workspace you can place any number of buttons or pictures, having any form or dimensions. All objects can run external programs or internal shell commands. The number of forms (screens) can range from 1 to 999, and the screen objects can be set to switch from one form to another. All settings and pictures are stored in a database. You can even make more than one database and use objects with links to go from one database to another.

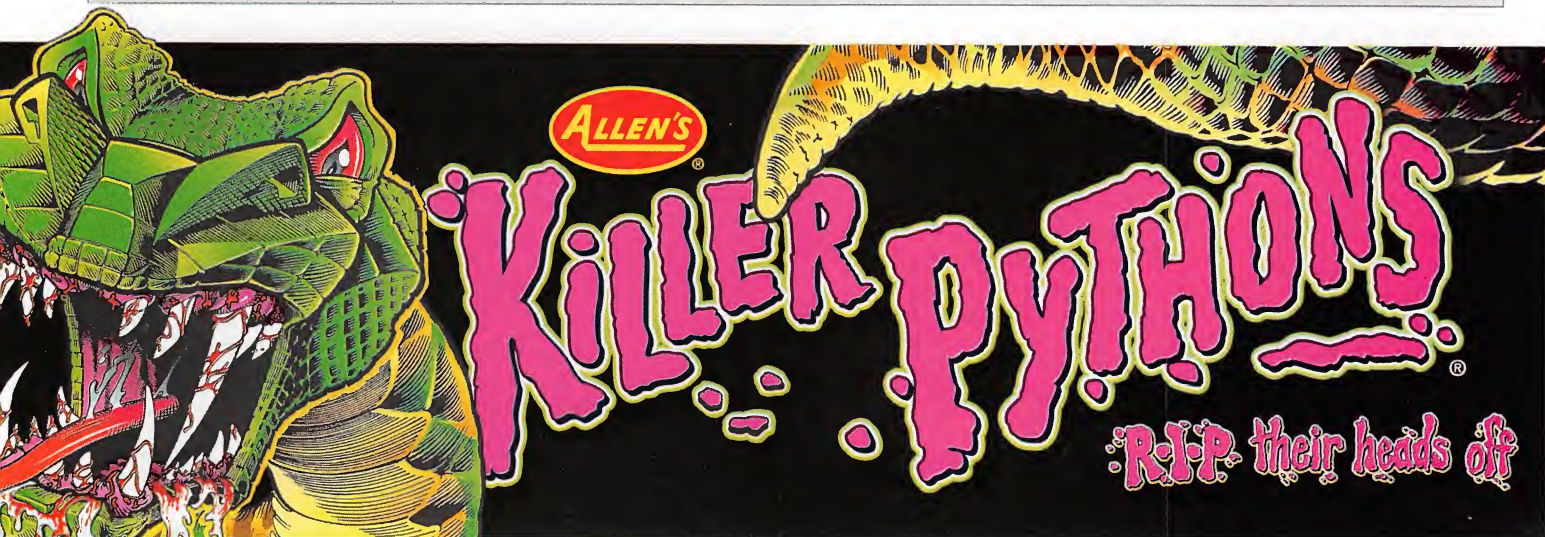

# GAMENEWS

**HEADLINES:** A Bathurst sim, finally • Grand Prix 3 • Diamond buy-out • System Shock 2 victim Nanny Gates • UK News • Kingpin Conscience

## SIDELINES

With its painstaking demand that you monitor every detail of your creation, SimCity 3000 is the perfect game for control freaks. Prospective town planners, however, might have felt that the tools provided by the game weren't quite enough. Heeding their cries, Maxis have released the SimCity Building Architect Tool to allow players to design their own buildings for use in the game. The more artistically-inclined will also be able to give existing buildings a fresh lick of paint. The BAT is free and available for download at any good gaming site.

Is it a sign of weakness or a company doing the right thing by consumers? The Aliens vs Predator save game issue has stirred up plenty of debate throughout the gaming community, after Fox Interactive chose to not allow players to save during a level. A vocal group of gamers protested against this design decision and, ultimately, a patch has been released to now enable a mid-level save option. We're in two minds about it: it's good that more people will now feel able to enjoy the game, yet at the same time they won't be enjoying it as it was originally meant to be experienced. Perhaps you would like to share your opinions on the matter...

Couple of rumours for all you strategy gamers out there. One concerns Microprose and the team that recently developed Star Trek: Birth of the Federation. Word is that after finishing up on the forthcoming patch, several of the team will commence work on a sequel to the cult classic Master Of Magic. Elsewhere, at Ensemble, plans are allegedly underway to further the Age Of Empires series beyond the sequel due later this year. Tentative ideas include a medieval scenario and a sci-fi setting.

If you've read Ashton's favourable review later in this issue, then you may already be on your way to purchase the impressive Heavy Gear 2. Well, you should hasten your step because Activision have given you another reason to debit your bank account. Heavy Gear Terraformer Tools is the name of the level and mission editor that allows the design of new maps for single and multi-play.

# BATHURST SIM ON THE WAY!

Australian developer Torus is currently mid-way through work on the game the Australian gaming community has long been begging for - a Bathurst racing sim. To be known as "Dick Johnson's Touring Car Challenge", the sim is scheduled for release close to Xmas this year.

At this early stage the plan is for the sim to comprise 4 tracks - Oran Park, Sandown, Phillip Island and, of course, Bathurst. Car-wise, you

won't be limited to just Dickie's Ford, while details are still being finalised, at least one Holden will be available for mountain thrashing.

We spoke to the developers and begged for a beta, which they declined to provide as the game is still not representative of the final build, so, alas, we are unable to report on the quality of the driving model. Torus are modelling all tracks on aerial photographs and contour maps, so at least that part



Why didn't we choose a picture of Dick Johnson? Answers on a postcard, please...

of the equation will be accurate. Dick Johnson's Touring Car Challenge will be fully networkable. More on this hopefully exciting new sim soon.



## FORMULA HASBRO

Cementing its (pole) position as the new motor racing kings, Hasbro Interactive has bought the games rights to Formula One for the next five years. Added to their NASCAR and GP 500 licenses, F1 consolidates Hasbro's almost total domination of the racing game section of the market. The first title to bear the Hasbro and Official Formula One labels will be - deep breath - Geoff Crammond's Grand Prix 3, courtesy of Hasbro's previous publishing deal with Microprose. We can't even begin to tell you how excited we are by this news. So that's all we'll say.

## S3 BUY DIAMOND



First it was chip-maker 3dfx picking up board maker and distributor STB. Now, in an identical situation, chip-maker S3 have bought board maker and distributor Diamond Multimedia.

The transaction involved an exchange of common shares, and is expected to be tax-free.

According to S3's press release, the reason for their purchase of Diamond is: "In a strategic move to capitalize on high-growth areas, S3 expects to emerge as a key player in the Internet appliance and home networking markets. S3 also plans to maximize the two companies' multimedia strengths to become a total solutions provider (silicon, software and PC boards) for its graphics business."

A PR spokesman also stressed that Diamond graphics products would not, now, rely exclusively on S3 graphics chipsets, such as the Savage 4, but would continue to utilize chipsets from Nvidia (TNT and TNT2) and other companies.

If this is so, then superficially nothing will change for the end-user. Creative Labs, Diamond's main competitor, will be wishing otherwise. If Diamond are forced to use only S3 graphics chips, Creative will be left as the only major source of TNT2-based cards. Creative will also retain the freedom to quickly utilise new chipsets from just about any silicon manufacturer.

# SYSTEM SHOCK 2

To promote System Shock 2, Looking Glass have been running a "Get Killed By SHODAN" competition where one lucky entrant would be granted the honour and privilege of, well, as it says, getting killed by SHODAN. From the thousands of entries (including us), LG have now announced a winner - a certain Brian Norris of St Louis in the US. Brian will be able to enjoy the dubious pleasure of encountering his own mutilated corpse aboard the hijacked space station, Von Braun.



# UK NEWS

by Steve Boxer

We're now well into what's known as the Silly Season over here. Basically, nothing happens in the mid-to-late summer, because everybody's off on holiday. So, therefore, there's no news. Thus the papers become increasingly desperate and start running utterly ridiculous stories. We'd like to assure you that at PC PowerPlay, dedicated newshounds as we are, we have no need to indulge in such silliness. Honest. Trust us, alright?

A few games have appeared over here unexpectedly. Most notably, the rather excellent MechWarrior 3 and the much-delayed (but not as much delayed as we thought it would be) Dungeon Keeper 2. But perhaps the most welcome UK arrival is Ultima Online: The Second Age. Yup, we guys now have our own Ultima servers. What about you lot? If you haven't, get lobbying now. Other welcome but unanticipated arrivals include most of French publisher Microids' output, which is being brought to us by good old Codemasters. Getting most play on this particular correspondent's PC: Unreal Tournament, AVP and the mighty System Shock 2.

Eidos is planning to make a big splash with Urban Chaos, the first and rather wonderful effort from Britsoft boys Mucky Foot. To hammer home the message that Urban Chaos is rather cool, Eidos have launched a competition for budding film-makers to produce something on an Urban Chaos theme, and the game will have an associat-



ed compilation album, Wipeout-style, when it arrives in October.

We hate to brag, but the UK is increasingly being seen as the hottest development scene in the world. To emphasise this, two shows are about to take place: Develop and Meltdown (organised by good old Microsoft). We'll report back. Meanwhile, BAFTA, the UK film industry organization, has been getting into games in a big way, with talks by Lionhead's Peter Molyneux and (on the subject of games and films) by David Puttnam. Apparently, Ubi Soft was surprised to get a visit on its E3 stand from Steven Spielberg (with several kids in tow), who wanted to check out Rayman 2, while Ben Affleck's production company spent time schmoozing Infogrames, as it's interested in acquiring the film rights for Outcast.



Infogrames has just raised £130 million through a bond issue, which can mean only one thing: more purchases by the fast-growing French publisher are imminent. That is, if it can find anyone to buy that it hasn't already bought. Meanwhile, we were pleased to see that even though it was swallowed up by Hasbro, the MicroProse name lives on: printed on the box of MechWarrior 3. Along, it must be said, with the names Hasbro and Microsoft (king of the mechs Jordan Weisman is a Microsoft man these days).

And finally (as people are wont to say in the middle of the silly season), I reckon I've found the perfect game to take you Aussies by storm. It's made by Empire Interactive, and it's called Sheep. Sometimes, it's very helpful to be half-way around the world....



## SIDELINES

French publisher UbiSoft have decided not to publish Mortyr, a first-person shooter in development by Mirage Studios. It shouldn't be seen as a reactionary move against violence games in the wake of certain events in America, but it will no doubt be interpreted as such. The situation is that UbiSoft, having recently bought out Interactive Magic who owned the publishing rights to Mortyr, felt that the game was not appropriate to its wholesome, "family" image. We've scratched our heads over this one and, you know, they could well be right. Amongst the bright, clean-living likes of Rayman and Tonic Trouble, nary an UbiSoft game exists that could be construed as dark or violent in any regard. Which obviously makes them an exception in the games industry.

Devotees of Epic's stunning technology demo, Unreal, will be pleased with the news that a mission pack is due for imminent release. Entitled Return to Na Pali, the twelve additional missions commence where the originals concluded and describe the events surrounding yet another spaceship crashing on the ill-fated planet. As you might expect, the Skaarj are back in force to make your life difficult, while three new weapons and three new enemies are present to lend some variety.

Production on the eagerly-awaited Final Fantasy movie is stepping up a gear. Capitalising on one of the games' great strengths - the cutscenes of both Final Fantasy 7 and 8 are still unsurpassed, the film contains entirely computer rendered animation. Recently, Squaresoft announced the high profile actors who would be giving voice to the numerous characters on screen. They include Alec Baldwin, Steve Buscemi, Ming Na Wen, Ving Rhames, Donald Sutherland and James Woods. Also, Square are currently compiling tracks for a Final Fantasy Anthology soundtrack. A must for all the J-pop fans out there.

An Ultima Online Game Master (GM) has been dismissed by Origin following allegations that said employee was involved in misconduct. In behaviour that can only be described as abuse of the position, the unnamed GM reputedly created a number of characters, all well-stocked with items and skills, and proceeded to auction them for sale over the internet. From now on, Origin will monitor all its GMs to ensure against further such incidents, while any UO players can report suspicious activities to complaints@owc.com.

## SIDELINES

Surely there can't still be people who haven't yet purchased Valve's mighty Half-Life? So it seems, anyway, as Sierra announce measures to ensure that it does indeed happen. To mop up the strays, they've endorsed the Half-Life Game Of The Year edition, a package celebrating the vast array of awards that Valve's masterpiece has garnered over the past six months. It comprises the latest versions of Half-Life and Team Fortress Classic multiplayer add-on. In other Half-Life news, Radioactive Software have been chosen to deploy efforts in the creation of a mission pack. Designated Half-Life: Chronicles, the pack explores events running parallel to those in the original release, showing what may have happened if Gordon Freeman had chosen different courses of action during the game. Sounds very interesting.

A special edition of Command & Conquer: Tiberian Sun will be made available to gamers who order the title directly from Electronic Arts online. The special silver pack features a manual signed by the development team and, more excitingly, either a NOD or GDI soldier figurine.

In other vaguely mech-related happenings, the Starsiege universe is rapidly expanding. To complement their hugely popular Starsiege: Tribes online experience, Dynamix are busy adapting the same game world for a single-player game. To be known as Tribes Extreme, this iteration will feature a solo campaign to prepare players for the plunge into multi-player, team-based combat. Should be released in the lead up to Christmas.

For copyright reasons presumably, Quantic Dream's Omikron will now be known as simply The Nomad Soul when it's released in the UK later this year. Those across the rest of the world eager to play this sexy-looking action/adventure should continue addressing it as Omikron. Or "that game with David Bowie in it", if you prefer.

When we reviewed it back in PCPP #29, we found the locally-developed, cyberpunk action game, The Creed, to be quite lovely indeed. To be precise, it was 86% worth of loveliness. Now finally, after a seemingly interminable delay, ZeroHour Studios have secured a publishing deal for distribution in both Europe and the USA. Apparently, while fending off complaints and concerns over the game's violent content, the developers have used the time wisely to enhance what was already a damn fine game. If the changes are of sufficient significance, we may revisit it for an updated review.

# ADULT GAMING KINGPIN

In what is undoubtedly a first for the games industry, Xatrix Entertainment have issued a statement responding to concerns over the adult content of their soon to be released Kingpin. What makes the statement so remarkable is that it will be on display during the installation process of the game itself. While it's encouraging to see developers acknowledging their responsibilities, we also hope that this might signal an industry-wide trend for a more mature approach to violence in games. Here's the statement from Xatrix President Drew Markham:

"In light of the recent acts of youth-related violence that have taken place across America we thought that you should know how Kingpin was initially conceived. Kingpin was never intended for children. This is a game with mature themes made for a mature audience. There was never any attempt to market or influence children to buy Kingpin. In fact, magazines in which advertisements ran were carefully selected to only have an adult audience. We also took special care to insure that the Mature rating appeared very prominently on the package as well as within the game.

"As the creator of Kingpin I sought to make something that would appeal to a mature audience. My influences in making this game were mostly cinematic, and I wanted to explore those themes and share them with other adults who have similar

Excuse me, Mr Policeman, sir. I'd like to hand in this awful killing machine I found on the street. It's a menace to society.



## GAME NANNY GATES

Microsoft are planning to include Game Manager software with the next version of Windows due for release next year. Functioning in a manner similar to internet software like Net Nanny, Cybersitter and indeed other programs already featured in Windows, Game Manager will act to block unwanted game content from appearing on screen. Parents will be able to determine exactly what sort of material would be filtered out and then configure a password to enable and disable the operation of the software. Proposed options include altering the colour of any blood (as Nintendo used to do) or removing it completely. Degrees of offensive language, nudity and violence will also be adjustable. However, one conceivable drawback for the system is that the game developers themselves have to allow their games to have Game Manager support. Whether anyone will do so is a matter of some conjecture, as similar Parental Locks have been tried without much success in the past. But it's nice to know the choice is there, we guess.

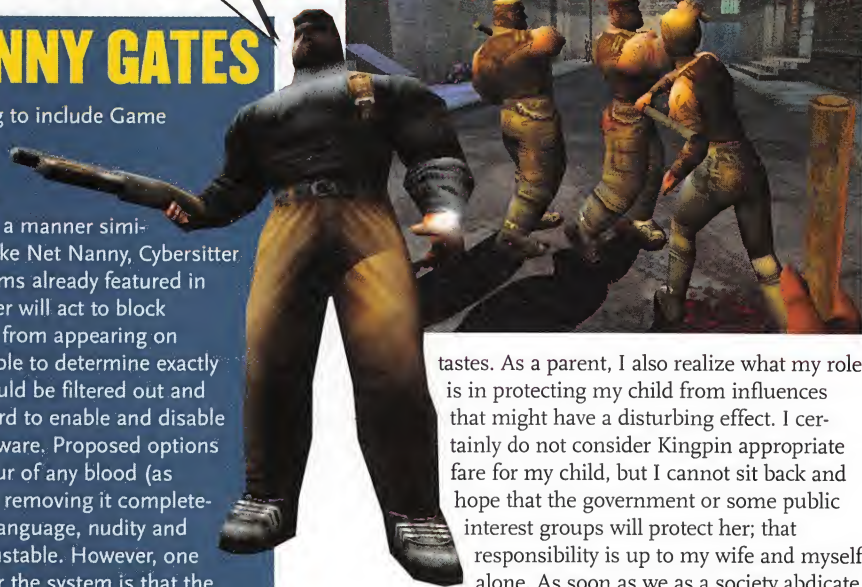

tastes. As a parent, I also realize what my role is in protecting my child from influences that might have a disturbing effect. I certainly do not consider Kingpin appropriate fare for my child, but I cannot sit back and hope that the government or some public interest groups will protect her; that responsibility is up to my wife and myself alone. As soon as we as a society abdicate our personal responsibility towards protecting and caring for our children we give up our basic freedoms as Americans; freedoms that have been hard fought and even harder won. As parents, we must look into our own backyards and see what our children are doing and become more personally involved with their activities, ideas and friends."





2048X2048  
Large Texture Support

# Pure Performance for Ultra-Fast Gameplay

- Based on nVidia's latest cutting-edge Riva TNT2 Ultra processor
- Explode through games at screaming frame rates that peak at up to 300 megapixels per second
- Delivers games in full 32-bit colour glory and enhanced with large texture support, bump-mapping and stencil buffering
- Designed with heat dissipating PCB and cooling fan, and Creative's Enhanced Blaster Control™ utility to allow maximum 3D performance and feature tweaking on your PC



**32MB**  
Ultra FAST  
SDRAM

**32BIT**  
True Colour  
Rendering

**24BIT**  
Z Buffer

**2048X  
2048**  
Large  
Texture  
Support

Sales Centre: 1300 367 773

Head Office 32-34 Dickson Avenue, Artarmon NSW 2064

<http://www.cppl.com.au>

Fax: (02) 9906 5577

**CREATIVE**  
P.A.C.I.F.I.C

# SUBSCRIBE

to Australia's PC Games and Entertainment magazine



**WIN A**  
**KODAK DC210 PLUS**  
**DIGITAL CAMERA**



TAKE ON THE GREATEST STRATEGY GAME EVER  
ACROSS SIX MILLENNIA AND THREE VAST MULTI LAYERED WORLDS

# 3 GAMES IN 1



## EXTENDED CIVILIZATION II

Just imagine... the classic Civilization II with:

- Extended timeline on Alpha Centauri.
- More Units, Advances and Wonders than ever before.
- New animated graphics and extended, deeper gameplay.
- Multiplayer games for up to seven people.

## UNIVERSE OF LALANDE 21185

Just imagine... a science fiction version of Civilization II. Crash land on and try to colonise the abandoned space stations and deadly gas plants of a Terran planet. Play simultaneously on 4 different 'planes' progressing through gateways to linked maps. Your ultimate goal is get back home alive.



## WORLD OF MIDGARD

Just imagine... a fantasy version of Civilization II. Engage in battles of military might with the mythical and legendary rulers beneath the sea, high above the clouds and deep within the twilight zone of the earth.



# 3 GAMES IN 1

# IN STORE AUGUST 1999

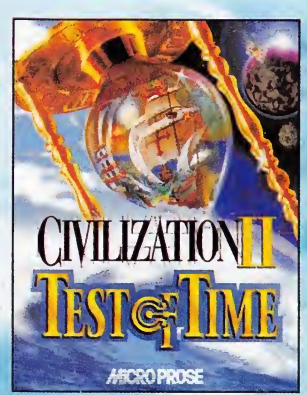

**MICRO PROSE**  
WWW.MICROPROSE.COM

YOU'VE CRUSHED ENTIRE CIVILISATIONS  
YOU'VE CONQUERED THE WORLD

WHEN ARE YOU GOING TO SHOW SOME AMBITION?

**\$1000**

**REBATE OFFER**

FOR MICROPROSE  
CIVILIZATION II PURCHASERS

Details inside box

CIVILIZATION II

TEST OF TIME

THE NEXT CHAPTER IN THE GREATEST STRATEGY GAME EVER

## Dell Dimension XPS T550 Desktop Fully Optioned - \$5159

- Pentium III550
- 64MB 100MHz SDRAM
- 16MB Diamond Viper TNT Graphics card
- 9.1GB Ultra ATA HDD
- PCI network adaptor
- SB Live!
- 40X CD ROM
- Separate 6XDVD ROM
- DVD Decoder card
- 17" monitor
- 56k Modem
- 3-piece speaker/sub-woofer
- Remote control

Big name, 'off-the-shelf' systems always get the suspicious treatment from the PCPP labcrew. Fine machines they usually are, but not suited to powergamers who like to tinker and upgrade frequently.

Dell we like, though. Everytime one of their machines turns up we pry open the case and marvel. Great interior design is their forte, and it's easy to



see. All components are neatly ordered, as one would expect. Most impressive is the cooling arrangement for the CPU. This Pentium III 550 has no attached fan, instead it sits inside a shroud that encloses a very large fan, venting straight out of the back of the case. A setup like this is just begging for overclocking, and shows the care and thought that went into the design of the PC.

Otherwise, the XPS T550 is your regulation, stinking fast, totally overloaded, gaming love beast. The unit they sent for testing was fully specced with the choice options. It had 2 CDs - one standard 40X, and a separate DVD connected to a dedicated decoder card, which includes TV-out.

Dell continually impress with their non-proprietary design and sheer power, prices will almost certainly be different by the time you read this, so check it out.

## Gravis Stinger RRP: \$79.95

Annoying nearby passengers on a flight is great sport. You can play 'armrest territorial wars', you can order a Kosher or Vegan meal so it arrives 20 minutes before the rest get fed, you can play 120 BPM techno on your walkman so the incessant 'BOOF' leaking from the headphones drives them insane after several hours, or, our favourite, is playing great looking games on a laptop, sending them mad with either envy or insurmountable distraction.

Laptops though, have fiddly little baby keyboards, and a near-useless for gaming touchpad thingo instead of a mouse. It all adds up to make the actual fun of playing far less gratifying than the fun of annoying your nextseat neighbour.

Not anymore! Gravis have forged an all-new peripheral category with their funky new laptop control pad. Qualifying it as a Laptop device is that it's little. Very, very little. Tiny, in fact. Called the "Stinger" (why?), it's got 6 programmable buttons, 2 shoulder buttons and a proportional analogue D-pad. Oh, and it's black.



# Hercules Dynamite TNT2 Ultra

RRP: \$539 • Contact: PSI - 03 9878 8611

Yes, we fully acknowledge that \$539 could buy your PC a healthy CPU upgrade, it could buy a metric ton of RAM, a beastly hard drive or a sexy new 17" monitor, but for pure, tangible, touchy feely, in your face satisfaction, look no further than the Hercules TNT2 Ultra. This is the current god-king of graphics cards, and we can't see that changing for some time.

Any TNT2 card with the 'Ultra' name on the box will be packing Nvidia TNT2 silicon guaranteed to run at 150MHz core and 183MHz memory. Indeed, most Ultras will ship at exactly this specification. If you wish to try and clock your individual Ultra any higher, the odds are that you will be successful, but it all comes down to the limitations of the particular core, memory and the PCB. Two seemingly identical Ultras, both from the same company, sitting side by side in the shop, will have different limits. Buying Ultra is a gamble if you want to overclock, but at least you'll know that as a starting point you'll smoke any other card on the market.

Hercules, determined to produce a premium product, meticulously test individual TNT2 and memory chips, hand-selecting those which run reliably at a whopping 175MHz core and 200MHz memory, and then



building their Ultra around these chips. The end result is the fastest TNT2 available anywhere.

Impressive as this is, there is still great potential to overclock these already hot chips. The test card Hercules sent us was tested at speeds up to 190MHz core and 220MHz memory, but after a few hours of running looped 3D apps, image deterioration crept in. Lowering the speed to 185MHz core and 215MHz memory proved to be the sweet spot

for this particular card, which is really quite amazing. Helping matters is the meatiest fan/heatsink combo we've yet seen on a graphics card.

The Hercules is the new pinnacle of 3D gaming graphics. Undeniably expensive, yes, but the \$539 price is comparable with other Ultra cards, and this one is clearly the Rolls Royce card for gamers.

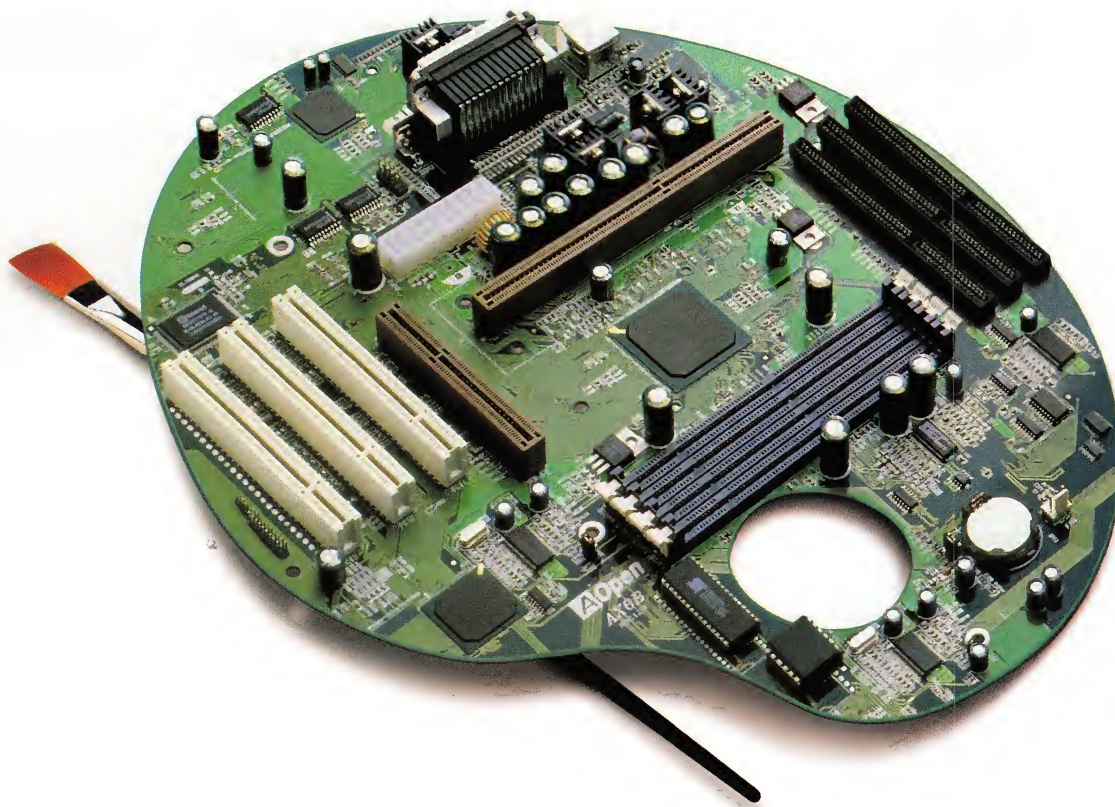

## INTRODUCING AOPEN'S NEW MASTERPIECES: THE AX63 AND AX6BC PRO MOTHERBOARDS.

Originating from the multi-award winning AX6B, AOpen has refined and created two new motherboards, the AX63 and the AX6BC PRO.

The AX63 enjoys the superior features of the AX6B, but utilises VIA chipsets and up to 153MHz clock frequency. In addition, the PC can be turned on through the keyboard or mouse.

**AX6BCPRO** The AX6BC PRO, utilising Intel's 1440 BX chipsets, supports the complete range of features of the AX63.

The voltage can also be adjusted through the BIOS menu, thereby giving users more stable control.

Of course, our motherboards exhibit their best performance and capabilities with AOpen's component collection of cases, graphic cards, video cards, CD-ROMs and DVD-ROMs.

For further information please visit our web site at: [www.servex.com.au](http://www.servex.com.au), e-mail to [ddeng@acer.com.au](mailto:ddeng@acer.com.au) or contact our distributors listed below.

**"...the best BX board on test."**

*PC @uthority - Motherboard test feature June '98.*

**"...it's a dream board for performance enthusiasts."**

*Editor's Choice - APC mag - BX Motherboard test July '98.*

**"...AOpen AX6BC is a faster board than the Abit BX6-2...more stable at higher bus speed, especially 133MHz and beyond."**

*BX Boards.com - 1999.*



Mainboards



CD & DVD Roms



Sound cards



Graphics cards



Cases

**AOpen**<sup>®</sup>

Component Solutions

# Gravis XTerminator

RRP: \$89.95

Here at Next Gaming we have the great pleasure of sharing office space with the homies that put together our multitude of console gaming mags. As such, we see all of their gear, specifically, the huge variety of control pads that come their way.

Of all the gaming peripherals out there, the control pad in particular demands ergonomic perfection in order to be loved on a regular basis. And wouldn't you know it, console pads are generally too small, are uncomfortable to hold and induce hand-aches that far exceed those usually experienced by your average single 14 year old male.

Well looky here. After an uncomfortably long absence from the Australian market Gravis have hit back with a vengeance. Their new XTerminator control pad is a marvel of ergonomics that had our consolies green with envy.



It sits

in your hand like it belongs there. It has dual D-pads - a smooth, free-floating digital pad raised nicely from the base, plus, just above it, the smoothest analogue D-pad we've ever seen. Lovely stuff. To the right, just above the regulation 6 buttons is a proportional slider for throttle control. Its' movement is fluid and not in the least 'notchy'. Below the buttons is a coolie hat, while around the back are 4 shoulder buttons - not one behind the other in that yucky Playstation way, but one above the other, so you'll always have a finger on each. Noteworthy too is the joyport plug, which is double ended so you can daisy-chain as many of these together as you want.

One would naturally expect this device to be fully programmable, which it is. The included software is just beautiful, with graphic depictions of the unit. Allegedly up to 59 different functions can be programmed, but please forgive us, readers, for not bothering to actually test this to its full potential. Out of the box the Xterminator has pre-programmed support for 63 different games, old and new.

Control pads don't generally get us too excited, but as far as that department goes, this is the best we've seen so far. It's black too.



# Logitech WingMan Extreme

RRP: \$99.95

By now you would have read previous bits we've done on Microsoft's Tilt gamepad with its motion sensing trickery. You may have seen one in the shops - you may actually have bought one. Potentially exciting and innovative new technology it is indeed, and as such, there's an inherent risk of it dying a slow, neglected death, regardless of how good it actually is. Such is often the way of new gaming technology.

The ball is rolling! There's life in motion-sensing pads yet! Logitech, makers of sexy looking and joyously functional peripherals, have entered the race. They call theirs the "WingMan Extreme", to differentiate it from the rest of the Logitech range, which also, mostly, seems to carry the same moniker.

Anyway, it works well. Noticeably better than the Microsoft Tilt, in fact. MS had a suspicious habit of demonstrating Tilt with only Motocross Madness - which it worked most excellently with. With other games it worked, but wasn't generally the preferred control method due to the lack of joystick-like precision. While the Logitech pad still isn't a joystick replacement, it's a big improvement on the Tilt.



We loaded up Descent Freespace (a Wing Commandery space combat sim), configured the Logitech and went for a blast. Undeniably, it felt weird, but the control was as good as you would want for a space sim, while the thrill of waving the pad around the place and having the ship comply was nice. Next on the testlist was TOCA2. As we've always said here at PCPP, driving games should be played exclusively with a steering wheel - and let's just leave it that way...

Motion sensing, though, has now transcended the gimmick barrier, and we can expect other peripheral manufacturers to follow suit. We wait with interest...

# Jet Leader 3D Deluxe

From: Guillemot • RRP: \$79.95

There is some crazy law of design, which seems to apply solely to joystick makers, which states: "the product must remind the user of either A: a penis, or B: what probably controls the space shuttle."

Well we think that's just silly. Funny, yes, but silly. What we want are sticks that serve the gamer well. Ergonomics, people! Please, lose the fluff and give us a stick that's designed for the human hand to effortlessly control the action in a computer game. Simple!

Hey! Look! Here's one! Resisting their racial tendency to overdesign, the French have come up with quite a handy device, in the Jet Leader 3D. We've been using it here in the labs for a weeks now and love it more every time we wrap our sweaty hands around it.

We like the soft padded hand rest that gently curves upwards, holding your hand in place while killing bad stuff. We like the

Analogue control means it's now feasible to play driving games with a gamepad



solid, positive buttons that click clearly, yet don't require any kind of hefty push. We like the clever positioning of the buttons and throttle wheel.

We especially like the very small footprint and we couldn't care less about the perfectly symmetrical design so left handers (you freaks!) can play too, but respect this as a nice touch.

The 'Deluxe' in the name refers to this stick's new digital interface, which means no more calibrating and far smoother movement on screen.

It's a nice shade of matt black too.



# Creative FourPointSurround FPS2000 Digital

RRP: \$599



The Cambridge Soundworks speaker kit has won our praise in the past, and for good reason. Their 4-speaker plus subwoofer set pumps out mighty sound from deceptively small Bose-like boxes, while for owners of soundcards featuring true surround sound capability, gaming has never been more immersive.

As with all good things, there's a New Improved model, and here it is, right here, right now. Buyers of the Cambridge Theatreworks 5.1 set will have noticed that the Center speaker is roughly twice the size of the satellites, the same satellites that ship with the Soundworks set too. Now, the FPS2000 satellites are all this same, larger size.

Big difference #2 is the subwoofer unit. It now features digital inputs, along with traditional analogue plugs. This digital design is only of benefit to owners of the SB Live! with the digital output from the card's daughter-board. Note that the SB Live! Value Edition does not feature the digital



daughterboard. Other soundcards with full digital output can also take advantage of the FPS2000.

When we tested the unit with the PCPP PC which has an SB Live! The difference in quality was negligible. There was a noticeable difference in quality, but not so much that you would want to trade an existing, early model Cambridge Soundworks for the new unit. But if you're sporting dull and lifeless speakers, then the FPS2000 should be considered at or near the top of the list. The main advantage seemed to be a more consistent maintaining of sound clarity at higher volumes.

Check it out at your games shop. Ask them to fire up Unreal, then let fly with the Razorjack and you will truly be stunned as the metallic projectiles ricochet around, above and below you seamlessly. There is never any discernable 'jump' from one speaker to another as the sound source, instead the sound just comes from wherever it should.

Magic gaming, just the way it ought to be.

## IF YOU'RE GOING TO PLAY, PLAY TO WIN!

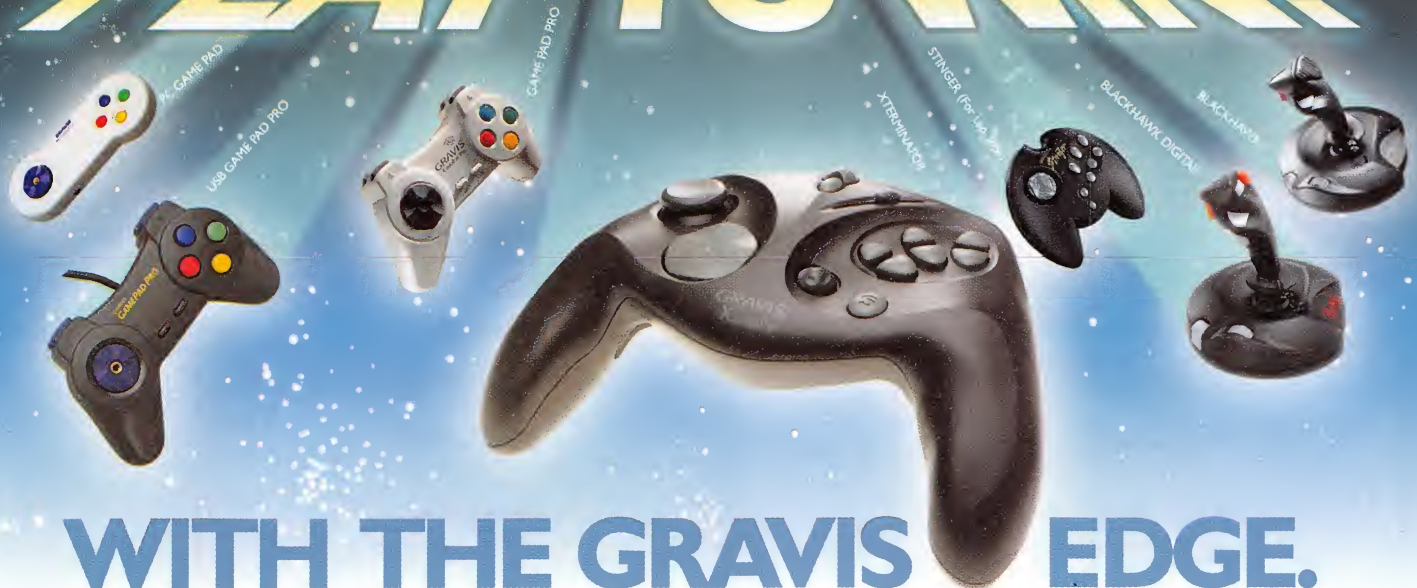

## WITH THE GRAVIS EDGE.

Gravis makes game pads and joysticks for gamers who don't play around. We are dedicated to giving you an extra edge. With precision control. Instantaneous response. And easy programmability that puts your favourite moves right at hand. Get the Gravis Edge. And play it for all it's worth!

AVAILABLE FROM  
HARVEY NORMAN  
GAMES WIZARD  
ELECTRONICS BOUTIQUE  
DICK SMITH POWER HOUSE



TRADE ENQUIRIES  
ACCO AUSTRALIA 02 9700 0180

www.gravis.com

# TIME TO CALL THE CABLE GUY

Ultimate Online Gaming Speed is here and now, provided you're ready to pay premium dollars for it... By Garry Wallis

Having the benefit of working as an IT professional, I have been spoilt by working for big corporations with fat pipes to the Internet. Net surfing with a 256Kbit/sec DDS fastway serial link will do that to you. After work, when I came home, I became sick and tired of having to dial up my ISP via my pitiful 28.8Kbps modem. Sometimes it can be bearable, until you try to do anything useful on this sort of connection like download a 50MB game demo.

## Foxtel's cable network

If you are one of the lucky ones that currently subscribes to Telstra's Foxtel cable TV service, then you already have a better option than those analogue modems that most of us use to connect to the Internet.

Foxtel has offered their Bigpond cable service, or Bigpond Advanced, as it is now known. What it allows you to do is connect

to the Internet via your current Foxtel cable connection.

## What you will need

You will of course need an existing connection to the Foxtel cable TV network. Once you have decided to connect to Bigpond Advanced, a second Foxtel cable connection must be installed in your house. To get this under way, Telstra have an online form available, surf to <http://www.bigpond.com/advance/you/index.htm> and fill in the appropriate information.

Your PC must meet the following type of system specs for the Bigpond Advanced Cable service to work.

- IBM Compatible PC
- Pentium processor
- Windows 9x or Windows NT4 Operating System

- 16 MB RAM (for Windows 95) or 24 MB RAM (for Windows NT4)
- A Free ISA or PCI slot (for Ethernet card)
- SVGA display 800x600x256 colours
- CD ROM drive
- 16 bit Sound Card or better and speakers

## How fast is it really?

Prepare yourself for Internet at hypersonic speeds, really, it can be that fast. The reason I say it can be that fast is that where the Internet is concerned a slow connection speed is not always attributed to your end of the connection. This tends to really show up when using a cable modem, that is slower servers can really slow down transfer even though your end is blazing along.

Most of the time the cable modem will load web pages almost instantaneously, especially if they are residing on the Telstra proxy servers. To actually provide you with connec-

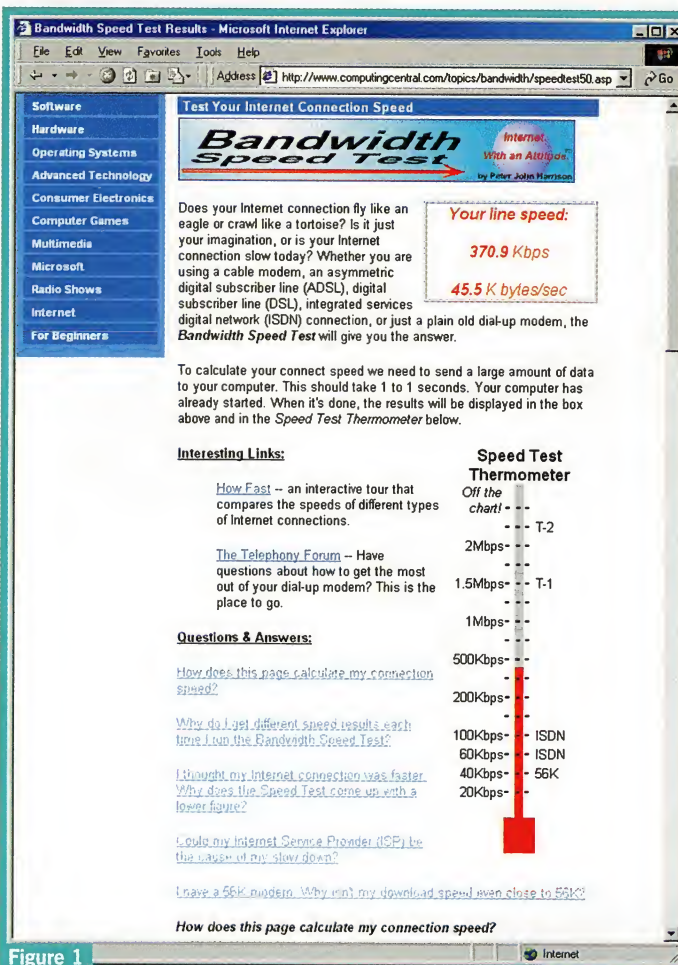

Figure 1  
26 PC PowerPlay

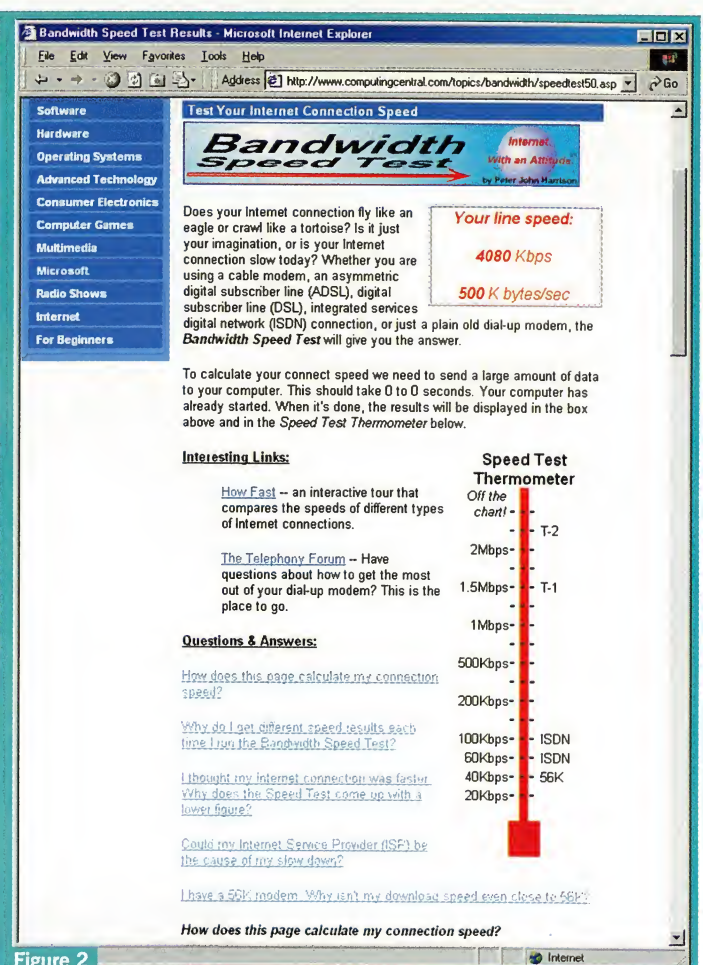

Figure 2



tion speed examples we used a really cool page <http://www.computingcentral.com/topics/bandwidth/speedtest50.asp> that is sitting on the MSN servers in America. What this page does is initiate a file transfer with you PC and ascertains how long it took. The page then gives you a transfer rate score and shows you on a chart how fast your connection is compared to some other standard connection types from a lowly 28.8K modem all the way up to a T2 megapipe.

The first test I did was with the Telstra proxy servers set to off. This gives you an idea of the raw connection speed that can be achieved to an American website. (see **Figure 1.**) As you can see, not too shabby at 45.5KB/sec, that's at least 10 times the speed as you would get with a standard 56K modem.

The second test was with the Telstra proxy enabled to show what the cable connection and modem is really capable of at full steam. (see **Figure 2.**) All I can say is WOW! 500KB/sec that's over 100 times the speed of a standard 56K modem.

This sort of connection speed is really only obtainable from servers that are directory connected to the Telstra backbone, but it certainly shows the possibilities.

Although the cable modem is fast, as I said before, if the server at the other end is slow you will still get the pages only as fast as the server you are requesting from can provide. Nearly all the popular websites that I have tried would give me transfer rates at least in the region of 20KB/sec, which still wipes the floor with an analogue modem.

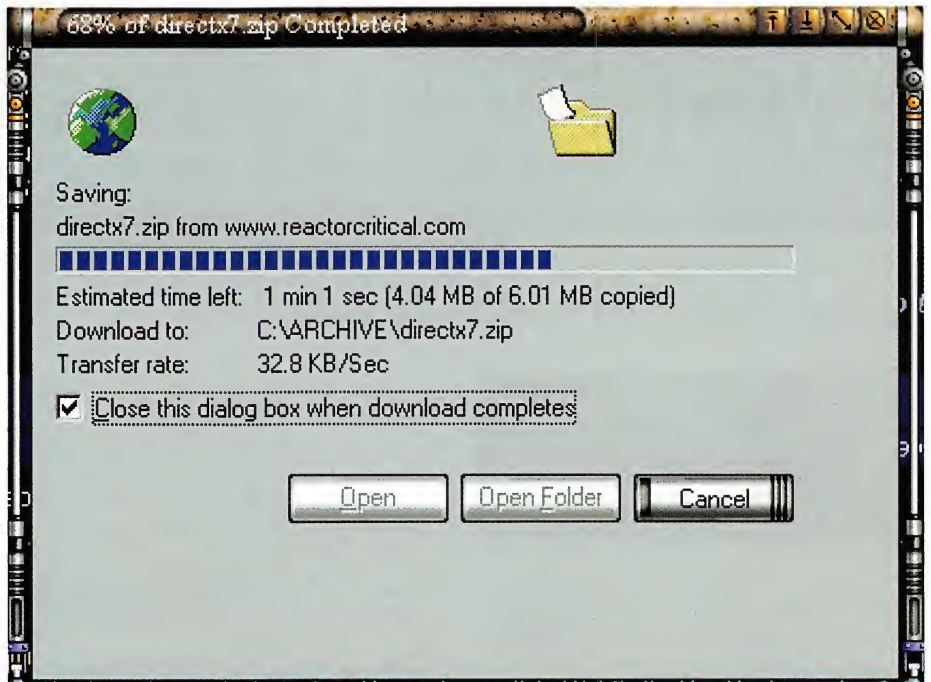

(top left) Now we know why he's on radio... Ugh!

#### Games at WARP speed - Wireplay WARP

Those of you that have been following online gaming would have heard about Telstra's existing game oriented service called Wireplay. All advanced cable customers can join Wireplay for an additional \$10 a month and get the added benefit of online games at WARP speed.

A cable connection is also perfect for playing games like Q3TEST. I had a couple of friends over after I got the cable modem to see what they thought, as they had only played Q3TEST via modem. 6 Hours later I still couldn't get them to stop playing. Even when playing the LAN only Quake 3 level over the cable modem was a dream with ping times ranging from 30 - 120ms.

#### Sounds great - how much?

As of writing this article cable modem connections still seem to be out of reach for many net surfers. Cable modems are a lot

cheaper than they used to be - you could pick one up for around \$470 mark. Which isn't too bad, except when you factor in the fact that Telstra's pricing model is based on paying for the information transferred instead of paying for the hours used online.

Telstra's lowest plan available for the cable modem is \$65 per month with which you get the first 100MB's of downloads for free but are subjected to a cost per addition megabyte after that at 35c per megabyte downloaded.

Hopefully when more people start using this service the pricing may move over to a more affordable fixed price unlimited downloads pricing model. When this happens it will be only a matter of time before everyone with a Foxtel TV connection will have their PCs connected to the same high-speed network. If you do have the money to spare now and are in a Foxtel connected locality then I would highly recommend a cable connection to anybody.

#### 25.1 MB of phantommenace\_demo.exe Copied

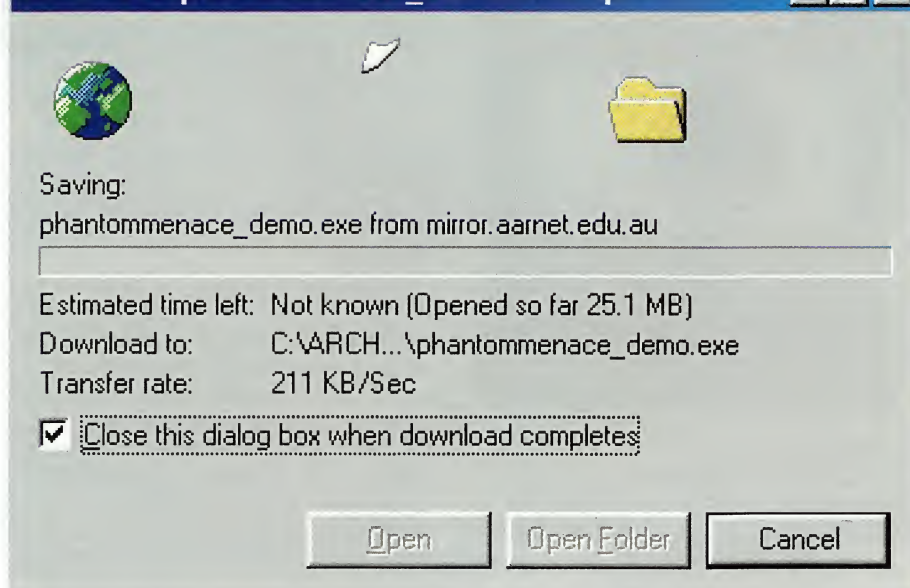

(left) We'd like to apologize for Garry's lapse in taste with THAT download.

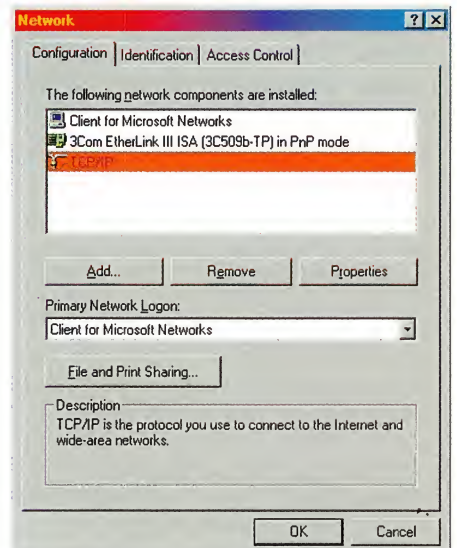

# Window Dressing



The standard Windows desktop is drab, dull and butt-ugly. Add personality and style with this handy how-to guide. By Garry Wallis



**EVERYTHING  
YOU NEED IS  
ON THE CD!**

I personally find the Windows 9x Explorer shell interface ugly and cumbersome. I bet you have seen pictures of Linux running the Enlightenment interface with the cool aliens theme and wished your Windows 9x shell could look like that. Well, you are in luck, as numerous companies are bringing to market applications and shell replacements that allow you to configure your GUI anyway you wish.

## What's a Shell?

Dating back to Windows 3.x the operating system has used a shell. A shell can be considered to be the application that is responsible for providing the interface to your computer's functions. The Windows 3.x shell was known as Program Manager (Progman.exe) the Windows 9x shell is called Explorer (Explorer.exe). During the upgrade process that people went through in going to Windows 9x, Microsoft added the option of using the older Windows 3.x shell for those who preferred it. This is achieved very simply by modifying the file called system.ini, which lives in the Windows directory.

To use the older Windows 3.x shell all that is needed is to change the line that reads

**Shell=Explorer.exe to Shell=Progman.exe**

What this would imply is that Windows has always been able to accept a different shell. IBM proved this with the release of OS/2 for Windows, which replaced the Windows 3.x program manager shell with the much more functional OS/2 shell.

## From Russia with love

So why has it taken so long for other companies or any one for that matter to produce a shell replacement? This is a tough question, the best reason I can think of is that the Microsoft Behemoth just doesn't like it. Information required to build a replacement shell was too hard to get hold of for most companies. I am sure they probably didn't want to cause any friction with Microsoft either. I believe the Russian software laws have had something to do with changing this. Before you say, "sure, what does he know?", listen to my theory.

By law, Russians are allowed to reverse engineer any software they purchase. That is the Software license that usually prohibits this activity for the rest of us is not valid there.

Russian programmers armed with a good decompiler can find out exactly how the Windows 9x shell interfaces with the rest of the system. Then they can pass on this information to us less fortunate programmers in the rest of the world.

We here at PC PowerPlay are not endorsing reverse engineering of Windows, but I believe it is our right as users of the software to have a choice as to what our GUI looks like, with Microsoft's present stand on the situation it seems to be the only way.

## The Essentials



### Shell Enhancers

Microsoft's own Themes application is an example of a shell enhancer, in that it changes the cosmetic appearance of the present Windows shell. Themes are integrated within Windows 98 and come as an option in the PLUS! Pack for Windows 95. What it allows is to change the background, cursors and some of the system icons to more preferred ones. Although Themes are interesting new programs like EFX and WindowBlinds show really what is possible with shell enhancers. These two programs are used to actually change the appearance of the windows within Windows.

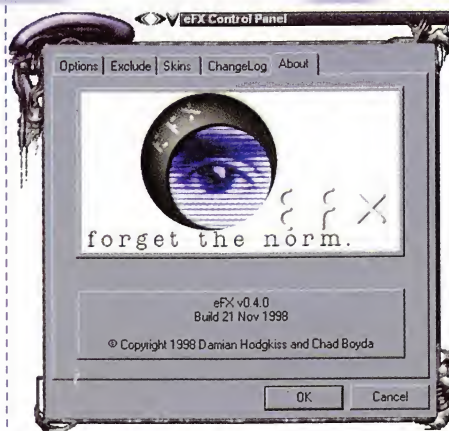

### Shell Replacements

LiteStep and Talisman are examples of shell replacements. They are loaded when Windows initialises instead of the normal Explorer shell. Shell replacements can go one

step further than shell enhancers, replacing the usual boring Start menu bar and desktop shortcuts with wharf bars and button icons. The whole look and feel of Windows can be so radically changed that less experienced Windows users wouldn't realise it still is Windows running under the hood.

### Can I still play QTEST3 though?

When these shell enhancers or replacement shells are installed all that is changing is the front-end or the GUI, this is the bit you physically interact with. All Windows functions are still doing their magic in the background so theoretically these applications should not interfere with other applications. Most of these GUI add-ons are still in beta which means there are still a few bugs. Sometimes you may find the odd application that gives up the ghost but I can assure you QTEST3 or any other game I have tried has worked flawlessly.

### Skins

On this month's CD you will find all the programs and variety of different themes or skins as they are commonly known for each program. Skins basically contain special information and graphic files to tell the relevant application how your desktop should look.

On the next few pages we will go through the procedure required to get your Windows 9x or NT system looking the way it should - Explorerless!

## Windows Enhancers



### EFX

EFX is a window changer that allows for some really cool looking windows. Thirty4 who are responsible for creating this program are still working hard on the code. The version we have here is preview version 0.4.0, which seems to be quite stable.

### Installation

EFX is distributed as a zip file so the first thing we need to do is unzip the file to your system drive in a directory called EFX. This can be best done with a copy of WinZip, before extracting the files create a directory called EFX on your system drive. Then extract all files to your system drive (ie. C:\EFX) and make sure to tick the use folder names checkbox to create the directories.

Once this is done you are ready to use it. Run the program EFX.EXE that is sitting in



the newly created EFX directory to see the difference these programs make. When EFX is running you will see its icon in your systray, double clicking on it will bring up the below screen. This is where all configurations for EFX take place including skin changes.

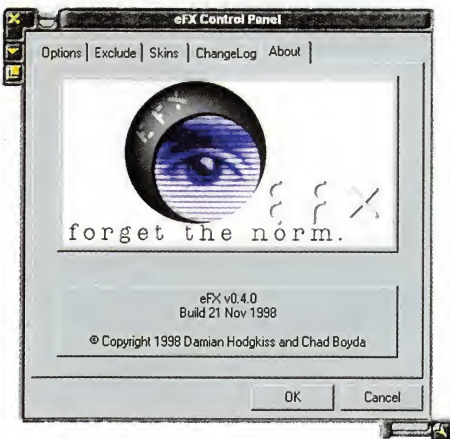

### Customisation and Installation of skins

New skins can be downloaded from many different places, check out the "where to go" box out. We have included a few EFX skins on the cover CD for you to try as well. EFX skins like the main package come as zip files. EFX skin zip files may or may not have the skin folder name stored in the zip itself. When you come to install some of the skins

you may be required to create the skins directory manually. When you open the zip file and it has a directory listed under the path list within WinZip all that is needed in this case is to make sure the use folder names check box is enabled. Extract the skin you want to use into the EFX\Skins\ directory and either create a directory for it or ensure the use folder names check box is ticked.

Once the relevant skin is extracted into the EFX\skins directory the skin should appear in the EFX skins window.

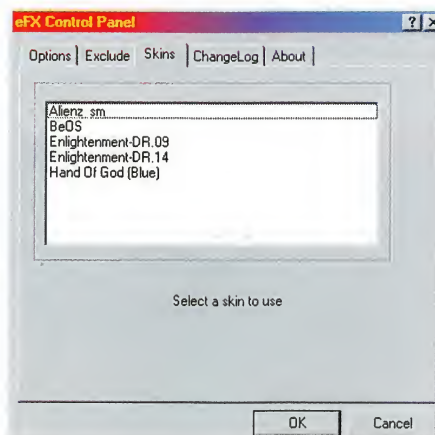

### Possible problems

While using EFX I have noticed that some applications tend not to get along with it too well. It is mainly confined to office

style application like Word and according to the readme file supplied with the distribution of EFX the exclusions editor is not fully functional.

We recommend that less experienced users go with the more mature and user-friendly window changer, called WindowBlinds.

### WindowBlinds

WindowBlinds actually goes one step further than EFX in that it can also change windows with backgrounds and change the default system buttons. By the way, Stardock, the company responsible for WindowBlinds, also offers a product called Object Desktop which includes WindowBlinds and a host of other cool Windows enhancements. We will hopefully have a review of Object Desktop in a future issue.

### Installation

The Installation procedure for WindowBlinds is very simple, just open the zip file and double click the wbo90.exe. Once WindowBlinds has installed you can choose whether or not it gets loaded at system start-up. When WindowBlinds starts it will change your window borders automatically and put itself into your system tray.

WindowBlinds makes it very simple to change skins, first double click the WindowBlinds icon in the system tray to



bring up the configuration options. Click the button "Install a new skin from a zip file" and then choose the WindowBlinds skin from our CD or you have downloaded. The new skin should then appear in the list of available skins.

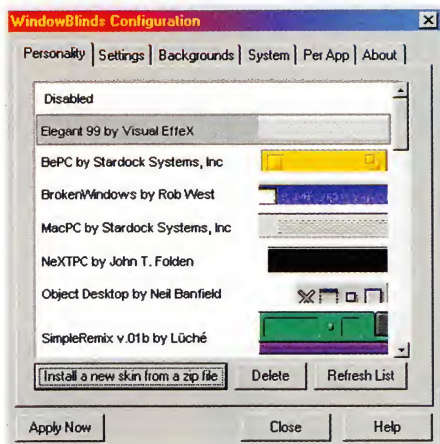

### Possible problems

Some of the options within WindowBlinds can sometimes cause graphic glitches, which causes some buttons to appear garbled. After installation if you notice any of these anomalies you

will need to change some options within WindowBlinds. The first option is changed via the Settings tab, uncheck the box that reads "Replace checkboxes and radio buttons with bitmaps". The next option is changed under the Background tab, uncheck the box that reads "Add bitmaps to dialog/MDI backgrounds". WindowBlinds does not seem to suffer the same problem as EFX, in that all applications I tried, even MS Word, worked flawlessly.

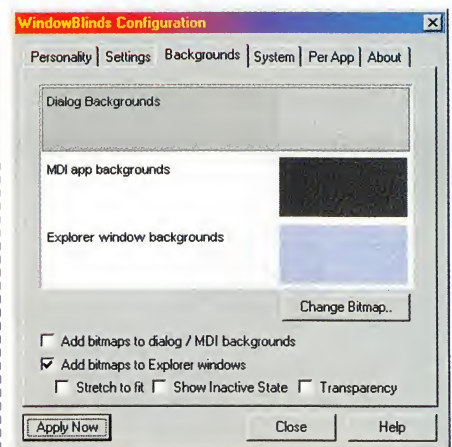
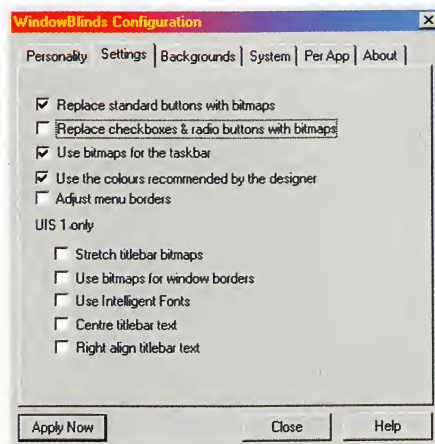

## Alternative Windows Shells

### Talisman

Talisman can either replace the current Windows shell or can run over the top of Explorer. Some of the key features that Talisman offers are:

- Creating multilevel user defined desktops.
- Use of any number of pictures of any type or dimension, instead of standard icons.
- Place, free-moving and imposing of objects in the Talisman workspace.





themes and skins but until then different skin archives will come packaged differently, some even include the LiteStep executable's themselves.

Changing skins in LiteStep is more trial and error than anything. Once the skin is unzipped into the directory the Step.rc file needs to be modified to point the program to the required files.

All LiteStep skins that are installed will include a button or a Wharf bar option for modifying the Step.rc file. The Step.rc is basically just a text file very much like INI files under Windows. Once changes are made to this file a special command called !Recycle must be run to enable the changes. !Recycle does exactly what the name suggests and restarts LiteStep with your relevant changes.

### Possible Problems

As LiteStep is freeware and Linux like in origin, it is not as easy as some of the other Shell replacements to get working. Although LiteStep has this fundamental issue it seems to be the most popular shell replacer available with well over 200 skins and customisations available for it. I myself am a strong believer in LiteStep and use it myself, but I must admit that I needed a couple of days before I was able to get a grasp of the program and its amazing power.

## Plus



### Other cool skinnable applications

Just for fun we have included a few other skinnable applications to complement your new desktop look.

### K-jofol

K-jofol is one of the coolest skinnable music players we have ever seen. Just install it and see what we mean. Some skins are included for you to play with as well.

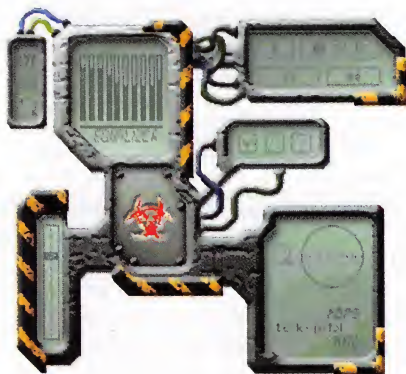

### Sonique

Sonique is similar to K-jofol but offers that little bit extra. The skins are incredibly cool too.



### 3D-FTP

Not another FTP client, well this one's different it is totally skinnable. Check it out.

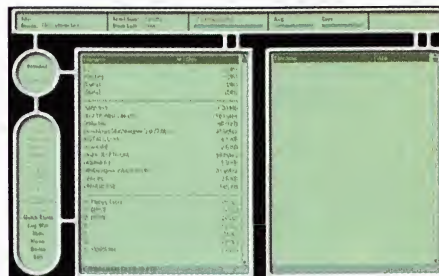

### More power to the people

Looking around on the Internet at the amount of people interested in these enhancers and you can see that it certainly is the way to go. How can Microsoft be as pompous as they are and expect every user to like and use the Explorer shell! LiteStep and WindowBlinds is the first sign of hope in years that finally users will be able to decide how they interact and use their computers by building their own environments that better suits them.

## Where to go



If changing the look and feel of Windows inspired you as much as it did us you will want to explore the possibilities. Below is a list of sites that are must visits if you plan on using or even creating your own skins for these programs.

### EFX Home

<http://Skinz.org/Thirty4/>

### WindowBlinds Home

<http://www.windowblinds.net>

### Talisman Home

<http://www.lighttek.com/talisman.htm>

### LiteStep

<http://www.litestep.net>

<http://www.litestep.org>

### Skinz.org OMG!

It's SKINtacular - Many skins available

<http://skinz.ozbytes.net.au>

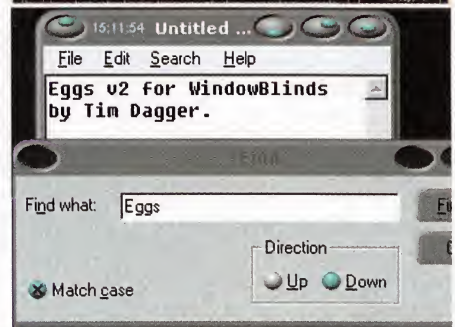
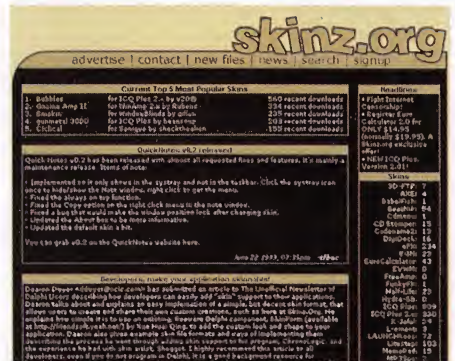

### Customize.org

Even more skins available here

<http://customize.org>

## Help!



There may come a time when you shell changes don't work and will lock up. Don't fret, you can change the default shell back to Explorer to perform the surgery.

Before the Start Windows message comes on the screen when your computer boots press the F8 Key. Choose the boot to MSDOS prompt option, and then change directories to C:\WINDOWS. Type "Edit system.ini" to change the default shell back to Explorer.

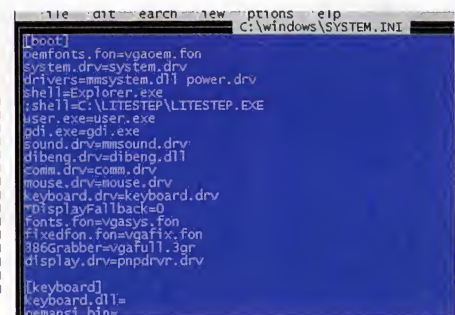



# Dramatically Different

The new Millennium G400 Series high performance video cards

## The Fastest

- › Explosive 3D, 2D and DVD performance
- › The only 256-bit DualBus graphics chip
- › Fast AGP acceleration and 16 or 32MB of memory



The fastest 3D performance

## The Sharpest

- › True Environment Mapped Bump Mapping for maximum 3D realism
- › Vibrant Color Quality<sup>2</sup> 32-bit rendering, texturing and Z-buffering
- › 300 or 360 MHz UltraSharp DAC for flicker-free displays

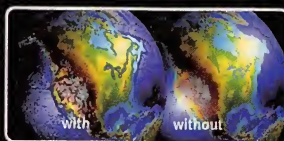

3D Environment Mapped Bump Mapping

## The Most Versatile

- › Unique DualHead Display supports two independent monitors with one AGP card
- › The only card to support 8 combinations of RGB, TV and Flat Panel monitors
- › Upgradeable with MJPEG video editing and Digital Flat Panel



One AGP card supports two displays

The Millennium G400. One video card. Endless possibilities.

G400 Web Site at:

[www.matrox.com/mga/g400/main.htm](http://www.matrox.com/mga/g400/main.htm)



Australian Distributor  
Focal Point Computing Pty Ltd  
(03) 9525 1144

**matrox**

# STATE OF PLAY

The lowdown on the latest in your favourite genre

## Adventure/RPG

David Wildgoose

What I'm waiting for:

**System Shock 2** - September

**Gabriel Knight 3** - September

**Deus Ex** - December

Let's begin with some rumour and innuendo. Word has it that Lucasarts are in fact at work on another *Monkey Island* game, though I'm certain you'll hear no official confirmation for some time to come. Obviously there are no hints as yet as to what it may be called, however the expectation is that the game will use an engine similar to that found in *Grim Fandango*. That's right, you'll be able to view Guybrush's weedy figure in polygons. My, Mr Threepwood, you animate like a dairy farmer...

Onto actual hard and thoroughly confirmed facts now, there have actually been a



few announcements recently concerning adventures in development. *Rent-A-Hero*, from German chaps neo Software, shouted its presence in the shape of a beta sent to us this month. Although the game was released in Germany at the end of last year, the English language version has only just been completed. Rodrigo (he of the absurd, New Romantic fringe in the screenshot) runs the eponymous Rent-A-Hero service, rescuing various damsels in distress and slaying the odd dragon when he needs a break. Visually it appeared reminiscent of *Discworld Noir*, with some lovely roving camerawork illustrating the in-game action and not just the cut-scenes.

Continuing the Teutonic theme, there's *Faust*, a pre-rendered epic based on the Goethe tale and from the makers of *The Ring*. Sure, *The Ring* (54% in PCPP #33) wasn't exactly a great game, but it was mighty pretty. If Arxel Tribe can extract at least some of Goethe's story crafting finesse, then there might be hope for it yet. If not, then at least it will, as I say, look nice.

To Sweden now, where Daydream have just released a demo of their forthcoming *Traitor's Gate*. Already garnering some praise in Europe, the game has the player engaging in some acts of counter-espionage involving stealing top secret documents from the Tower Of London, of all places. Unfortunately, as much as I tried I couldn't get the damn thing working, so I can't comment on how successfully it captures the James Bond atmosphere for which Daydream were striving. Plans are in motion to do so next month, though.

## Action

Edwin Dawson

Current Versions

**TRIBES: 1.5**

**Half-Life: 1.0.1.0**

**Blood2: v2.0**

This month we were totally blown away by *Midtown Madness*, which is one of the most freeform driving games we've ever seen, even compared to *Carmageddon!* Driving in a big reconstruction of Chicago, you hoon around anywhere and everywhere with hundreds of buildings, destructible objects and heavy traffic to negotiate. It's got a delicious physics engine and total vehicle destruction stuff, too. Check out the demo, it's an insane experience. Get it off the net at <http://www.microsoft.com/games/midtown/>



The folks at Valve Software, makers of *Half-Life* recently released a small set of levels that were available before the game shipped, but virtually nobody bothered to get them because at the time the demo was a whopping 50 megs.

Well, if you've got the whole game, and the 1.0.0.9 patch, you can go grab these excellent levels right off the net, and at a reasonable 10.4MB, because it uses files already installed with the full game.

It's called *Uplink* and it's placed sometime after Gordon escapes the Black Mesa Research facility. The levels are really polished and as excellent as any in the full game. Especially if you have already finished it, it's totally worth getting. And hell, it's free!

To download *Uplink* for *Half-Life*(1.0.0.9), do the following.

- 1) Connect to the net.
- 2) Launch *Half-Life*.
- 3) Click on 'Custom Game'.
- 4) Click on 'Refresh list'.
- 5) Select the *Half-Life Uplink* demo from the list.
- 6) Click on 'Install'. (wait for download to complete)
- 7) Click on 'Activate'.
- 8) Start a new game.

It's that easy! Free new levels - gotta love it!

## Strategy

Brett Robinson

*Imperium Galactica* fans are certain to be heartened by the news that a sequel is in the works. Due for release later this year, *Imperium Galactica 2* will join the ever expanding space based RTS fray. The game will feature three campaigns, each played from the perspective of a very different faction. Humans, constantly adopting expansionist policies, will match wits and weapons with the militaristic Kra'hen and the industrious Shinari. While the 3 campaigns won't be dynamic per se, all will include several randomly generated missions in order to spice things up for those who have already completed them on previous occasions. Tactical space battles will involve 3D units but will occur on a 2D plane. The developers



have chosen this simplified method in the hopes of avoiding confusion and maximising ease of use. Up to eighty planets will also be available for colonisation and drainage of resources, paving the way for spectacular C&C style land battles. IG2 will ship on four or five CD's and a DVD version will be released soon after.

With *Dungeon Keeper 2* on release schedule (review next issue) and *Theme Park World* on the horizon, it looks to be a year of big name sequels for Bullfrog. *Theme Park World's* new engine will feature 3D support and a number of interesting new features. The gameplay formula will be largely identical to *Theme Park's*, with some notable differences. Players will have the unique ability to walk around created parks and ride the attractions, all from a first person view. This is a feature superficially similar to the 'possess' spell in *Dungeon Keeper 2*, though for obvious reasons TPW players won't be able to stride around slaying visitors. It will also be possible for players to upload their park designs to a web server, for others to download and travel through. *Theme Park World* should be available in stores within a couple of months.

Also due for release over the next few months are *Monopolization* and *Disciples*. The former is the sequel to the not-so-well-known *Entrepreneur*, while the latter is a turn based fantasy/strategy game in the same vein as the *Heroes of Might and Magic* series. Both titles will receive further coverage as more information comes to light.

## Sims

Maj. Ian Lindgren

The last quarter of the year, and as is the norm, the games companies start jockeying for the release dates that will give them the strategic advantage. Some will release too early, and have others leapfrog their technology, others too late, and some just on time.

Still on target is Jane's *F/A 18* and Titus' *F/A18 Super Hornet*, both due for release in October/November. "Call the Ball" in the US Navy's 21st Century bigger, better, meaner, extended range, high payload beasts that will replace the aging F14s from 2001. The new APG-77 radar allows it to detect and identify targets at up to 80 miles! The graphics look stunning. Stand by for catapult launch! Which one will have the goods?

Jane's *A-10 Warthog* is all still go and set



for release just prior to *F/A 18*, with its mammoth seven-barrelled cannon, extensive damage modelling, and accurately represented titanium-protected cockpit. How will the sim react if a round can pass through the airframe? Guess we'll have to wait and see!

On target too is Hasbro's *B17 the Mighty 8th*. I'm starting to see the "inside" views of this multiplayer sim where many people will "man" each aircraft. I thought the inside of a B-17 in *Fighter Squadron* was good! Believe me, the *Mighty 8th* leaves it in its contrails!

For those of you that have heard of Eidos' *Confirmed Kill*; forget it, it's been killed! If memory serves me correctly, that's the second Eidos Flight Sim to be axed in the past 18 months.

*Gunship III* is still on the way, with its concurrent multiplayer support to *M1A2 Tank Platoon 2* (or maybe 3). Players will be able to fly the AH-64D Apache, AH-1Z Cobra, Eurocopter Tiger and the Mi-28 Havoc. Bigger, better, best - Flight sims all the way!

## Sports

John Dewhurst

It seems that Hasbro Interactive is making a serious effort to become a major contender in motorsports gaming. They have already announced plans to develop titles with Grand Prix 500 and NASCAR licenses but in recent developments, Hasbro have announced a lucrative five year deal with Formula 1. In the coming years, we will see a number of multi-platform racing games.

With the recent involvement of legendary MicroProse racing sim designer, Geoff Crammond, Hasbro are certain to make an impression with its racing titles.

The first titles we're likely to see out of all of this are *Grand Prix World*, a follow up to *Grand Manager 1 & 2* and *Grand Prix 3*. Expect these in early 2000.



Papyrus is responsible for the much lauded, however criminally difficult *Grand Prix Legends*. The next title due from them is *NASCAR Racing 3*. A successor to *NASCAR Racing 2*, using the same engine, it does enjoy some major renovations. And bear in mind that it isn't using the *Grand Prix Legends* engine (big sigh of relief), so that mere mortals may also be able to play. *NASCAR Legends* is also on the cards, and both look to be around at the end of this year.

From the THQ stables, where wrestling titles are known to hail from, comes *Ultimate 8 Ball*, the next big thing in Billiards gaming. Some of the features include 3D rendered opponents to challenge, 14 different pool modes, 15 table sizes and a physics engine to rival reality itself. Add to that, multiplayer options, including tournaments with up to 16 players and we have a title to watch.

Right on time for our northern cousins but looking to be a little early for Australian gamers is WizardWorks' *Xtreme Sports Arcade - Summer Edition*. The events included in *Xtreme Sports* are Half-Pipe Skateboarding, Skyboarding (yay!), Street Luge, Rock Climbing and In-line Street Skating. We'll just have to wait for howling guitar soundtrack and radical outfits that are features of this games. Expect it later this year, perhaps just in time for summer...

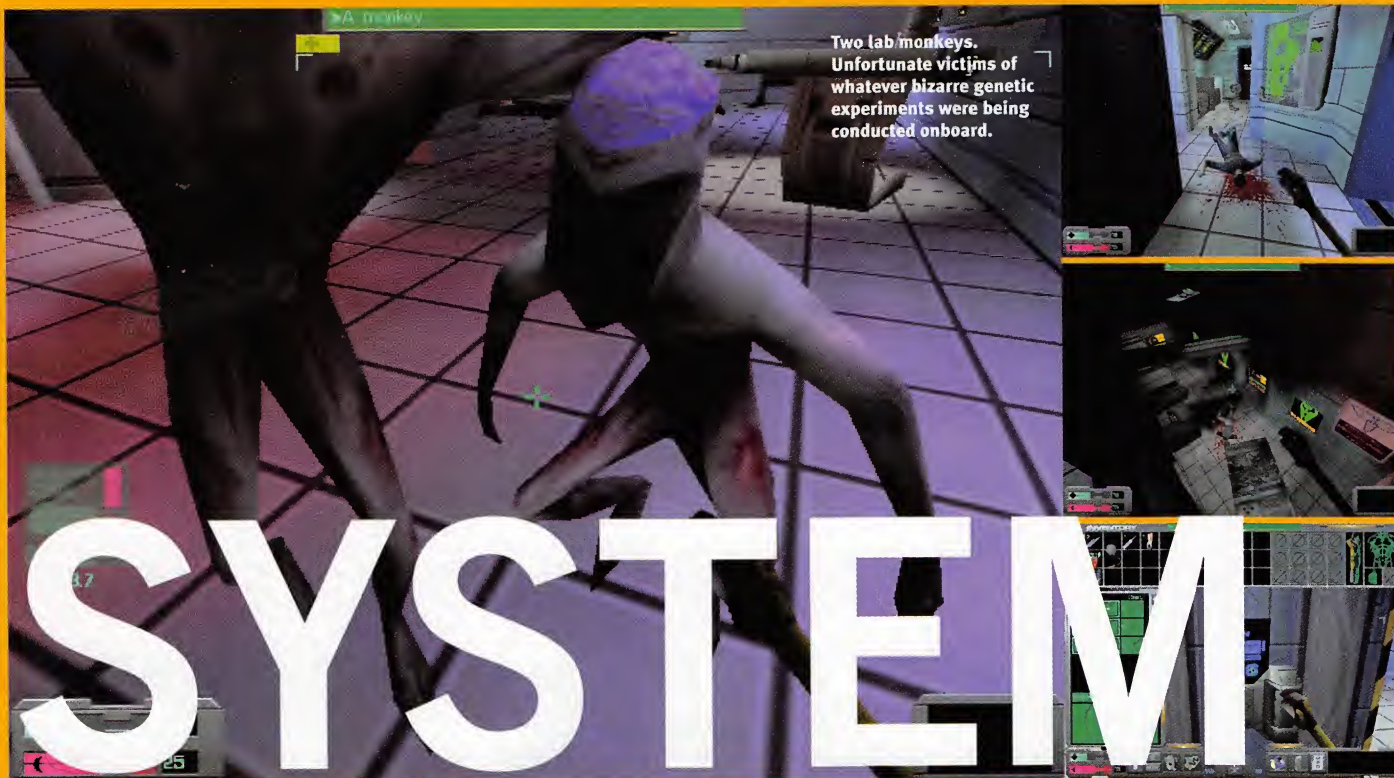

# SYSTEM SHOCK 2

■ Genre: Action/RPG ■ Players: 1-Multi ■ Developer: Irrational/Looking Glass ■ Publisher: EA ■ Due: September '99

Looking Glass Studios' original System Shock is probably close to the gaming world's best kept secret. Although dismissed by many Doom-addicted gamers when it was released, it has built a strong following during the intervening years among those who recognised the brilliance of its marriage of first-person action and role-playing. Now we have the sequel emerging in a climate that would appear more receptive to such a type of hybrid game. Highlighted by Half-Life, Thief, Outcast, and the like, the current trend is for action games with brains, either in the shape of a deep, compelling story or increased levels of interaction. At this late stage System Shock 2 seems to have both these areas

covered perfectly, so let's take a closer look.

### It's only August...

Actually, I ought to mention here at the outset that I'll be revealing a few early plot details, so if you're already an SS fan and don't wish to hear any spoilers whatsoever then I'd advise you to quit reading now. Rest assured, however, that the game is already well on track to equal its predecessor in terms of style and atmosphere. It's looking bloody fantastic, okay?

In a disorienting move for those who played the original, the game begins in a terrestrial environment. Those of us lucky enough to glimpse the SS2 alpha some months back, where the action commenced on board the



troubled space station, Von Braun, found this change a little confusing as well. After spending a little while wandering

It's obvious something terrible has happened to the Von Braun. There are dead bodies everywhere and you didn't kill any of them!

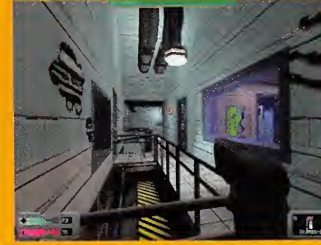



around the gorgeously-lit futuristic streets, the initially quizzical eyebrows in the PCPP office had reverted to their normal position. You see, when you start a new game, you are actually signing up to join the UNN and undergo their extensive training schedule before you're allowed to even set foot on any space station, troubled or not.

**But this is already...**

Once through the basic and advanced training courses - two cyberspace rooms that function as extremely useful and effective tutorials - you need to decide which of the three available careers you wish to pursue. Essentially these act as character classes as you might find in a typical RPG. Well, a typical sci-fi RPG, of course. Joining the Marines sets you up as a potential weapons specialist, while a Navy position gives you a head-start in various technical skills and the OSA (Black Ops) allows you to fine tune those latent psychic abilities.

With your career now selected, you must now serve three years tour of duty to complete the character creation sequence. Depending on the class you chose earlier, you will be offered a further choice of three year-long postings that each have the effect of increasing some of the various skills your character possesses. For example, if you join the Navy, you might then opt to spend a year each as a Ship Ops, Navigation's Mate and Lab Assistant, gaining experience in

their respective fields of hacking, research and general cyber technology.

**A major contender for...**

The entire process outlined above takes place in the imposing UNN building, with you walking around the appropriately sleek, high-tech corridors and catching sight of the various other employees working away at their computer terminals. All told, it's a far more interesting and rewarding method of character creation than the usual screen of statistics and plus and minus icons. For seemingly such a simple design decision, the dividend in terms of generating atmosphere - not to mention a sense of place and purpose for your character - is immense.

If the preliminary stages serve to grab your attention in a novel fashion, then the opening scene of the game proper only ensures that feeling of immersion is complete. Within seconds of waking from cryogenic sleep aboard the Von Braun space station, a radar dish explodes outside the window, metallic debris tumbles to the floor and a frantic voicemail message instructs you to get the hell out of there. Only afterwards do you notice the splatter of blood on the floor, though you're not sure

to whom it once belonged. From here on it's a race to safety, steering clear of both collapsing sections of the station and a number of "security" mutants plodding about the place.

**Game of the year**

What really impresses about System Shock 2 is the way Irrational have managed to balance the disparate gameplay elements. When faced with a problem - say, several security cameras alerting the mutants to your presence - there are always a number of different solutions. You could, for example, choose to shoot out the cameras one-by-one as you encounter them or hack into the security computer and disable the entire system. Of course, before that you're faced with the dilemma of getting

**That hulking yellow robot is a menace. We still haven't figured out how to destroy it yet...**

either the necessary weapons or hacking skills in the first place.

Thus far, System Shock 2 looks like a deeper, more complex and better looking version of the original game. First impressions indicate that the stomach-tightening, all-alone-in-outer-space scariness has been retained, but with the added bonus of sexier visuals and sound and a painless yet powerful interface. March and I are gearing up for the co-op multiplayer game right now - he's the psi-guy, I'm the hacker, and we're still seeking a weapons expert. We should have a review in the next couple of months.

*David Wildgoose*



# GIANTS

■ Genre: Action/Strategy ■ Players: 1-TBA ■ Developer: Planet Moon Studios ■ Publisher: Interplay ■ Due: 3rd Qtr 99

## Is big, is good

You know you're in for a special treat when you get to the genre description of a game and start frothing at the mouth uncontrollably in disgust or ranting at innocent bystanders simply because you don't think it does the game any justice.

Calling *Giants: Citizen Kabuto* an Action Game is a bit like calling Uluru (Ayers Rock for the colonists out there) a bloody big rock. It's true, but it's a bit of an understatement. It also completely fails to capture the real significance of the thing.

Which is exactly the same problem facing *Giants*. The love child of a bunch of ex-Shiny guys

(some of which created the grossly misunderstood action shooter, MDK) under the new guise of Planet Moon Studios and a collectively burgeoning imagination, *Giants* is the type of game that transcends genres and previous gaming experiences. At the heart of *Giants* lies a 3D third-person perspective action shooter. Though after a short time with the game, it's hard to shake the inexplicable feeling that you're playing something very special. It's a shooter, right, but with a warmth, personality and sense of humour not yet approached in a game. The only game that comes close to this one is their afore mentioned shooter, MDK.



Tastefully naked chicks in an American game. Whatever next?

The basic premise of *Giants* is a struggle for power on a beautiful and most-Eden like Island. Each of the three species want control, and peaceful negotiation is out of the picture. This struggle continues over more than thirty levels, with the player getting the rounds to control each of the three main species on The Island. Obviously, *Giants* is set outdoors, in the most beautiful 3D environment ever created for ANY game. The careful use of tone and colour creates a world that is absolutely breathtaking. Combined with a complex and cheeky array of character animation sets, *Giants* is one of the prettiest looking games out there.

With each of the three races being quite different in both the

looks and abilities department, Planet Moon have still managed to pull off a near perfect sense of balance. So much so, that perhaps *Giants* will be most fun when played in the multiplayer arena. At least, the potential for an unrivalled multiplayer experience is abundantly clear.

*Giants* won many E3 attendee's game of the show, and it's not surprising why. In a world where new, original and personality-driven seem terms to mark passing fads, *Giants* is a refreshing take on an well-worn genre that features an abundance of quality gameplay. You can't afford to miss this one.

## THE TRIBES

There are three primary forces on The Island.

**Kabuto** - This guy is the most menacing of the three species on The Island. Kabuto is the name of the only giant residing on The Island. Using brute force above all else, Kabuto can quite easily crush anything in his path. Combined with an energy meter (which is sustained by eating such things as the natural fauna or The Island's unfortunate natives), Kabuto has a handful of special moves up his sleeve that involve his hulking mass. Thanks to his strength and size (Kabuto's at least ten times larger than any of the other inhabitants), he doesn't need to worry about using weapons. The obvious disadvantage of using Kabuto is his lack of agility and speed.



**Sea Reapers** - A species of scantily clad (we're talking perky here) ethereal females of the aquatic variety. Playing as Delphi, you have access to powerful ranged attacks and perhaps the most impressive tool of destruction yet - the tornado/whirlwind attack. It has to be

seen to be believed - whipping up the enemy into a whirling frenzy of solid objects an enemy appendages. The visual effects that surround the Sea Reapers are top class too.

**Meccaryns** - Hi-tech race of humanoids with a powerful arsenal of weapons. Small, weak and fast, the Meccaryns rely more on strength in numbers to overcome the enemy.





There aren't enough games heroes wearing nappies, if you ask us.

# MESSIAH

■ Genre: Action/Adventure ■ Players: 1-TBA ■ Developer: Shiny ■ Publisher: Interplay ■ Due: 3rd Qtr. '99

## It's almost here...

Yeah, the religious overtones may shite a legion of gamers out there. So before you start crying "Foul! Moral-evangelistic murder!" take heart in knowing that as a (cute) little angel called Bob, you're out to cleanse the Earth of all its evil ways in a most ungodly manner. No, not by standing on street corners ranting and raving at anything that moves till spittle forms at the corner of your mouth. By using absolute and utter force. Fancy cleansing an appendage from a sinner's pathetic existence?

There's a little problem when it comes to doing this though. In his natural Earthly form (as a chubby cherub), Bob doesn't quite have the faculties to inflict any significant damage on the living. So Bob has the deft ability to possess the living. Style of gameplay is directed primarily by the type of character you possess. Some have access to awesome firepower, satisfying the action quotient of the game. Others, like the beautifully sculpted female street workers, rely simply on looks to gain access to areas otherwise off-limits. With over fifty

different human and animal characters to possess in Messiah, efficient adaptation to the immediate environment is a skill that will often be put through its paces.

Messiah is quite simply a 3D, third-person perspective action game. It borrows quite heavily from other genres however, particularly the RPG. While the player has much freedom to use anything from brute force to wily subterfuge to progress through the game's 14 levels or so, there are plenty of situations where careful analysis of your surroundings and playing in character (role-playing) will be called for. For example, if when possessing a simple law enforcer you happen to not follow the norm of behaviour in the presence of your colleagues (you know, the simple things like scratching yourself in public; shooting first, asking questions later), you will most likely arouse suspicion. Continually flaunt the standard and you'll soon have a sizeable group of angry policeman on your tail, bent on bringing your little crusade to an end.

"The AI is unlike anything you've ever experienced before," says programmer Michael 'Saxs' Persson. "In other games, ene-

mies are locked into specific environments, so it's easy to script out all of their actions. They're limited to 'knowing' a specific location in the world. In Messiah, Bob can possess a character and take them halfway across the world and then return them to their own control. Now, in a new situation and environment, that character has to act intelligently. Add to that the fact that your enemies learn how you play, and the game gets pretty eerily smart at some points in setting traps for you," he mused.

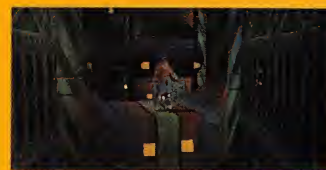

After the many delays of Messiah, Shiny are finally on the home stretch. The surprising thing is that even after all the advances in gaming and technology since the game was announced, Messiah looks, both visually and conceptually, more promising than ever. Expect a full review very soon.





# PLANESCAPE: TORMENT

■ Genre: RPG ■ Players: 1 ■ Developer: Black Isle Studios ■ Publisher: Interplay ■ Due: September

## An RPG with a handful of twists!

The similarities between Planescape: Torment and Baldur's Gate are striking indeed. Both Torment and BG make use of official Advanced

Dungeons and Dragons' rules and settings. Torment, like BG, also uses BioWare's real-time Infinity Engine. And the clincher, they've both been developed by Black Isle Studios - Interplay's immensely successful Role Playing Game division (the same bunch also responsible for the recent Fallout phenomenon).

There's much about Planescape: Torment that will, however, ensure that it isn't overlooked as just "a game using the Baldur's Gate engine".

The story, above all else in Planescape: Torment, is what drives not only the game's reprisal, but its creation. So much so, that Guido Henkel, Senior Producer of the game took great liberty to remove "unnecessary elements" from the existing AD&D rule system that came with the engine and was so faithfully reproduced in Baldur's Gate. While the team have the utmost respect for the AD&D rule system, they have a greater respect for narrative - the essence they believe drove the original Dungeons and Dragons movement in the first place.

Character creation is the first section where this design philosophy takes form. All the comprehensive skills are gone, with only the core player stats tweakable. A whole host of other RPG staples also been omitted in the game so that players can concentrate less on micro-management and more on the storyline that unfolds.

This limiting of diversity in Torment would normally cripple your typical RPG. Black Isle have gotten away with this in Torment thanks to the extremely flexible and diverse scenario used.

AD&D's Planescape setting contains a multiverse of differing planes of existence, where anything goes. With this setting, Black Isle promise the most diverse RPG, at least in visuals and setting, ever made.

Other changes to the engine since BG include a 2x increase in the perspective, allowing for much more detail to be seen, and a removal of much of the interface clutter from the main game screen. Replacing this is a floating menu which is brought up with a right-click of the mouse button. Black Isle have also opted to go with floating text instead of full window character speech.

Although these changes and features on their own are liable to induce incomprehensible utterings of delight, they pale in comparison to the story. You play a scarred, amnesiac immortal in search of his identity. That's right, an immortal. Death is not a concern in Torment, at least in the typical sense. It seems others are fully aware of your past deeds, and many people want you dead. Regaining fragments of your past, and past lives, becomes a priority. Even in death much is revealed, and most of your experience is gained.

Planescape: Torment deservedly joins the PCPP most anticipated list, in the RPG category.



Cynics have already dubbed this *Fallout's Gate*. But it isn't, honest...



# Mig Alley

UP CLOSE & PERSONAL

**empire**<sup>®</sup>  
INTERACTIVE

Korea in the early 1950's  
You & 99 others all at once

exclusively distributed by:



[www.metrogames.com.au](http://www.metrogames.com.au)



# INTERPLAY DOES STAR TREK

Ask a Trekkie what they get out of their beloved Sci-Fi universe and you won't ever get the same answer twice.

For some, it's the almost tangible sense of plausibility. That every minute detail of Star Trek's physics, even after years of careful and meticulous dissection, could and would meet approval from the most unforgiving of scientists.

It's the sort of stuff that (many Trekkies like to believe) would even get a glowing nod from the likes of Einstein and Newton. Hah! As for the Star Wars universe... We won't even bother trying to justify that sorry excuse for science fiction.

For others it's the character of the series. From Captain Kirk's wily and romantic escapades to Spock's

exploration of his uniquely feminine side, the Star Trek universe just oozes with personality.

Others still go simply for the special effects and unique aesthetic of the series. Clean and techy.

And thus the game development elite are releasing a Star Trek Title For Every Occasion™. As revealed at May's E3, there's a whole collection of 'em coming

our way, whether we like it or not. These releases can be split into two distinct groups: the hard-core sims and the fluff (consisting of adventure and first person games). Interplay have got three Star Trek titles in their fold - Star Trek: Starfleet Command, New Worlds, and Klingon Academy. All three incidentally, satisfy the hard core strategy element.



## STAR TREK: STARFLEET COMMAND

■ Genre: Strategy ■ Players: 1-TBA ■ Developer: 14 Degrees East ■ Publisher: Interplay ■ Due: 3rd Qtr. '99

Of the three titles on offer from the Interplay stables, if not of all of the Star Trek titles on the imminent release schedules, Star Trek: Starfleet Command is poised to be the most eagerly embraced by both hard core Trekkies and general gamers alike. It builds on twenty years of expertise as seen in Star Fleet Battles - which is an extremely intricate strategy board game (you know the type, those that include reams and reams of statistics, tomes dedicated to lavatory power requirements and schematics on great big space wessels). In other words, it's a highly detailed space combat/strategy game, that also happens to be in real time.

While extremely complex, Command surprised PCPP at a

recent tour of the Interplay studios with its inherent accessibility. Forgetting the already detailed tutorial missions included, Command requires nought but a general understanding and appreciation of basic weapon systems. If you know how to press fire and point your phasers in the general direction of the enemy, then you've got what it takes to become a proficient Starfleet Commander. That's not to say that Command is a simple matter of point and shoot warfare - there's enough detail in this one to satisfy the most anal of Trekkers.

Although Command is quite stat intensive, there are plenty of sections that are easy on the cranium. At the heart of the seemingly endless number of sub



menus and screens lies the 3D tactical display, from which you get a tidy visual representation of the fruits of your labour.

Command allows you to play through a huge campaign consisting of 6 different chapters - one for each of the races used. The satisfaction that comes from having a detailed story line interwoven with complex gameplay elements is great indeed.

Star Trek: Starfleet Command is the one to keep an eye on if hard-core strategy happens to take your fancy.





## STAR TREK: NEW WORLDS

■ Genre: RTS ■ Players: 1-TBA ■ Developer: 14 Degrees East ■ Publisher: Interplay ■ Due: 3rd Qtr. '99

New Worlds is a Star Trek flavoured RTS which has been in development in (of all places) Bath, England. It's been created for the many Star Trek fans that want a bit more of an action element to their strategy game as opposed to the in-depth system as seen in Birth of the Federation and the above mentioned Starfleet Command. Fear not though, New Worlds promises to be more than a mere Red Alert rip-off.

The design specs are ambi-

tious indeed, with the developers aiming to merge strategy, diplomacy, exploration and adventure elements. Rather than being restricted to the battlefield, events in New Worlds will require the player to command StarFleet forces, explore uncharted planets and liaise with new alien species before engaging in traditional RTS combat.

With over 20 missions on offer, New World will allow gamers to play through as either the Federation, Klingons or

Romulans. With an impressive and robust 3D engine, and a slew of new and familiar units to play with, New World is set to please.



Right, and the Star Trek hovertank was featured in which episode?



## STAR TREK: KLINGON ACADEMY

■ Genre: Space Sim ■ Players: 1-TBA ■ Developer: 14 Degrees East ■ Publisher: Interplay ■ Due: 3rd Qtr. '99

Klingon Academy can be summed up almost perfectly with the following statement: it's Starfleet Academy with Klingons, done good. With the satisfying ability to wipe out a vessel-full of fashion clueless Starfleet officers at your disposal, this is obviously not just a game aimed squarely at the Trekkies.

The developers have spent an inordinate amount of time implementing a detailed physics engine to ensure gamer's get a much more convincing realisation of Star Trek space combat. Detail is such that players will be able to see the scorch marks of phasers upon the enemy vessel's hull, or the interior workings of a ship after a torpedo has torn its

hull to shreds.

Also in Klingon Academy - a greater importance placed on environments. For example, flying into a nebula will have varying effects on your systems, and will require a different approach accordingly. As a Klingon, you'll also be able to fly through the rings of Saturn and have deal with the immediate effects of a nefarious black hole.

## STAR TREK XXVII: THE UTTER CONFUSION

It may be Star Wars season what with the recent release of The Phantom Menace, but if the computer game industry is anything to go by, Star Trek is what's hot. With titles being released left, right and centre from various software developers, it's making sense of this onslaught a bit of a hit and miss affair. Fear not! There is some basic order within the chaos that is Star Trek Gaming Merchandise.

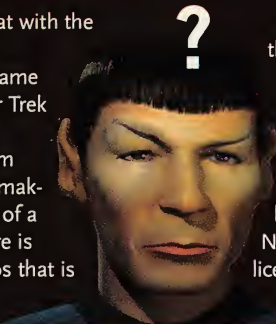

As far as Interplay go, they hold the license to do any Star Trek title based on the "classic" series (including the movies). That is, Kirk, Sulu, Spock, Scotty, etc are all characters that are allowed using this agreement. Titles based on Voyager or Deep Space Nine, for example, are not. This license is legal and binding, being taken with the series' distrib-

ution company - Paramount Studios. The Paramount licensing crew are around to ensure that any third party extension of the Star Trek world satisfies continuity, and is in place directly in response to the ravenous and particular fans of the series. That is, stuff like Kirk's beer gut increasing in size proportionally to the passing of time, and the Spock, Kirk and Scotty love-triangle never being officially recognised.

All in all, the Interplay series of Star Trek games get the Paramount seal of approval.

# DESERT FIGHTERS

■ Genre: WWII Flight Sim ■ Players: 1-64 ■ Developer: Dynamix ■ Publisher: Sierra ■ Due: October 99

**A North African WWII flight sim. How wonderful. I don't believe we've had one of these before...**

It's a pleasant feeling to once again slip into the cockpit of a Dynamix flight sim. I can remember the excitement, way back in 1991, of games that were supported by the first sound cards; Aces over the Pacific, Aces over Europe and of course the original Red Baron. They were the days on my old Osbourne

286 with 1 MB of video memory!

Well, Dynamix have continued to build quality sims over the years, and the Aces series certainly had many patches. From what I see in Desert Fighters, Dynamix appear to have used these to develop a knowledge base that will end up presenting us with a new flight sim sensation.

## Desert yellow

Desert Fighters gives us a change of scenery; no cruising over the English Channel or lapping of the Eiffel Tower. This time we go down town North Africa during the period March 1941

to December 1943. This was the "Battle of Supplies" as Rommel and his Afrika Corps pushed their lines of communications to the limit, and likewise so did the Allied forces. Neither side could move without resources, because the desert gave none!

During this period the main



Fly past a Pyramid in a Me 109



and air war, and this will add some spice to the game.

Dyanamix claim that the game incorporates 200 randomly generated missions in any one of four Campaign lengths at 50, 100, 150, or 200 mis-

sions. Time will tell if they are randomly generated because that sounds like "canned" missions to me!

## Sandstorm!

As for gameplay, it's pilot against pilot in pure air to air roles, Combat Air Patrol missions protecting your supplies, and of course you also have the opposite when you are attacking the enemy ground forces. This is going to occur through very inhospitable terrain to destroy enemy supply convoys, bridges and facilities. The realism will be further enhanced as you fly through

players were the English (and Dominion), German and Italian Air Forces, and later in the period the US sent support. Desert Fighters follows this historical link and allows you to fight in all four forces giving us over 30 aircraft with 18 flyable models including the multipositional Ju-87 Stuka, the Italian Macchi MC 202, and of course the trusty Spitfire and Bf-190. Your air battle influences the ground battle, so you are participating in a ground



PREVIEWS



The Italian Macchi MC 202 in one of the many flexible view options. Realistic Carnivore.



scorching desert canyons, over shadowy dunes, and through blistering sand-storms.

On the graphics side the game is starting to measure up well, offering 640 x 480 to 1024 x 768 resolution. Cockpit art modification will be part of the package, but is only in a rudimentary form in the beta I have flown.

#### Dismembered aircraft

I couldn't get a feel for flight modelling to any great degree, but I noticed that support will be offered at three levels from Novice to Professional. Damage modelling was starting to take shape with a clarity of dismembered aircraft parts breaking off when hit by enemy fire, or striking the ground.

I've only flown the single seat fighters in the demo, but multipositional play in this game will be exciting if you're the rear gunner in a Stuka dive-bombing a convoy and you have to defend your aircraft from attack while the pilot is concentrating on the target. This is the future of flight simming and

Desert Fighters has it!

In fact, multiplayer support was the beta's main capability, it logs on automatically to the net. Then, just like Activision's Fighter Squadron, it finds all Dynamix Desert Fighter servers. The listing tells you were each site is, how many players it has, and what the ping rate is. Great stuff; I had a ball, even if I was restricted to an area around one of the Pyramids! Name tags, chat while play; this game has it all built in.

Roll on October, Desert Fighters will be one of the contenders that appeals to a wide cross-section of the flight simming community.

Major Ian Lindgren



The Game Finder lists all current Desert Fighters servers, shows you the ping rate and how many players are logged on. The game can take up to 64 players on one server.

# ABOMINATION: THE NEMESIS PROJECT

■ Genre: Action Strategy ■ Players: 1 ■ Developer: Hothouse ■ Publisher: Eidos ■ Due: 3rd Qtr 99

From the makes of Gangsters (85% in PCPP #34) comes another game that thinks the world is conveniently arranged into a neat square grid. Meet the isometric-ly-viewed, alien-invasion action of Abomination.

At this stage, it's looking remarkably X-Com-esque, which is hardly surprising when you consider the lead designer of Abomination actually worked on the X-Com series before joining Hothouse.

While the city-under-siege backstory may seem overly familiar, the dynamic mission structure is novel enough to warrant attention. Apparently there will be 200 or so missions to tackle, each requiring between five and ten minutes to complete. The cleverness arrives with the fact that all missions are generated on the fly, so that hopefully no two games will feel too similar. The gameplay copies the



mighty X-Com: Apocalypse in that it offers a real-time mode with the option of pausing at will to survey the battlefield and

(right) Hey, what's up, Doc? Oh, a rocket launcher, I see...

issue new orders. Unlike X-Com, however, tactics and strategy are emphasised to a lesser degree than straightforward carnage and destruction. Your squad is required to get in there, roast those aliens, and get out as quickly as possible. Although we're unsure of the accuracy of such a comparison, the word Syndicate was what immediately sprung to our collective minds.

Perhaps the most interesting feature concerns the pool of characters from which your combat squad will be comprised. Bearing the hallmarks of comic book heroes, each charac-

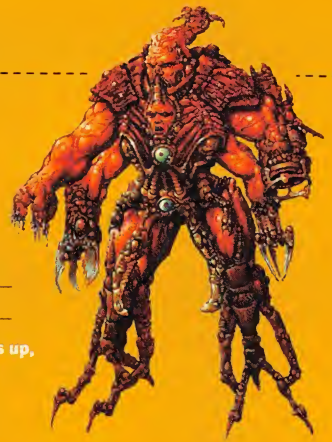

ter possesses a superhuman ability that will evolve throughout the game, assuming you can ensure their survival. A nice role-playing touch allows for experience points to be accumulated by characters you manage to carry from one mission to the next. In addition, Hothouse promise there'll be a plentiful arsenal on hand to satiate even the most bloodthirsty player. Which is nice.



# URBAN CHAOS

■ Genre: Action Adventure ■ Players: 1-Multi ■ Developer: Mucky Foot ■ Publisher: Eidos ■ Due: 4th Qtr 99



Pre-millennial tension filters the air in the new sprawling combat/adventure game from Eidos. With gangland warfare on the rise in Union City, the so-called Millennium Cult has seized the chance to consolidate its power over the nefarious underworld. Predictions of armageddon and the apocalypse are on everyone's lips in an ambience reminiscent of cool sci-fi flick Strange Days. Let's hope the promised release date

of Urban Chaos later this year isn't too prescient.

Developers Mucky Foot Productions can boast several former Bullfrog employees in their ranks, but that's not why Urban Chaos looks so exciting. Despite the mission-based structure of the gameplay, Mucky Foot inform us that you'll be able to explore the city as you please. They've worked hard to create the city as an open environment that actively encourages the player to roam freely

throughout its alleyways, rooftops, subways, and main streets.

You take on the role of either Darci (a hand-to-hand combat specialist with a penchant for concealed weapons) or Roper (a big gun kind of guy who packs an arsenal of Uzis and assault rifles) in tracking down the Cult leaders and steering clear of the police. The choice of characters should allow for a decent degree of variety in the methods for tackling each mission; while Roper can leap in all-guns-blazing, Darci must adopt a more stealth-based approach.

One of the more light-hearted touches in this proudly gritty and grimy game centres around the multiplayer options. In addition to a straight deathmatch mode, there's also an amusing variation on the old capture-the-flag idea. Only this time, however, the premise is capture-the-briefcase. Presumably it's a really expensive one with a clever false bottom containing confidential documents or something.



Just another Saturday in Hyde Park really...

The HEART of your car  
**DOESN'T** beat  
under the BONNET.

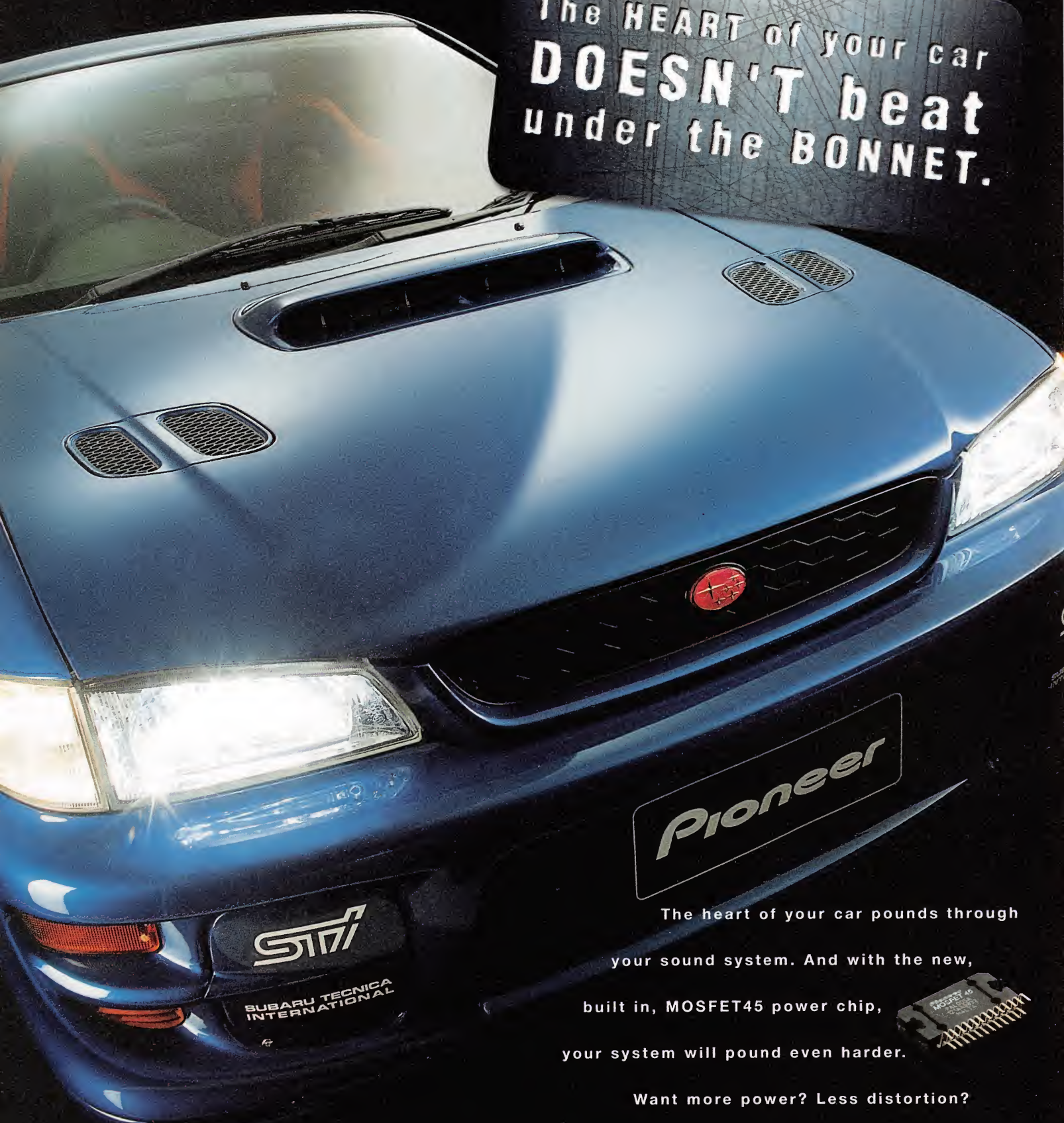

The heart of your car pounds through  
your sound system. And with the new,  
built in, MOSFET45 power chip,  
your system will pound even harder.



Want more power? Less distortion?  
Better sound? Call the people with the world's  
most powerful headunits on 1800 060 853.



MOSFET45 - Maximum power, built in.

**Pioneer**

# ODIUM

■ Genre: Strategy/RPG ■ Players: 1 ■ Developer: Metropolis ■ Publisher: Interplay/Monolith ■ Due: 4rd Qtr 99

It's 2008 and NATO is still having difficulties in Eastern Europe. Only this time it's not thanks to a crazed Serb political leader, but an even more alarming situation - genetically-challenged mutants. When a similar unreported incident happened in Russia several years before, the affected city was entirely destroyed. With the world's media in attendance this time, however, things aren't quite so simple.



Makes Fallout look like a holiday by the sea.

You play the role of Cole Sullivan, but only because Bruce Willis was unavailable. Accompanied by three fellow NATO soldiers (their distinct talents complementing your own ability to, like, blow stuff up), you slip into the Polish city of Lubin where the half-man, half-insect mutants have taken up residence and attempt to ascertain just what the heck is going on. Said end should be accomplished throughout an alternating mixture of turn-based strategy and real-time role-playing.

At heart, Oidium is a turn-based strategy game where you employ your four-man squad through all manner of dangerous locations, exploring increasingly horrific scenes and barely clinging to sur-

vival. Your squad receives experience as they progress, enhancing their abilities in the process. Fleshing out the atmosphere is an extensive narrative that boasts diverse paths through the game and sub-quests aplenty.

The game's Polish developers, Metropolis, promise Oidium will play like a strategy game in the vein of X-Com or Incubation, yet still possess the depth of a good RPG like Final Fantasy 7 or Fallout. Evidencing such a claim is the detailed degree of environment interaction allowed. From searching drawers and using objects to solve problems to talking with other characters and mutants, we anticipate significantly more interaction than in other squad combat titles.

Having recently hit its alpha stage, Oidium is scheduled for an October release.

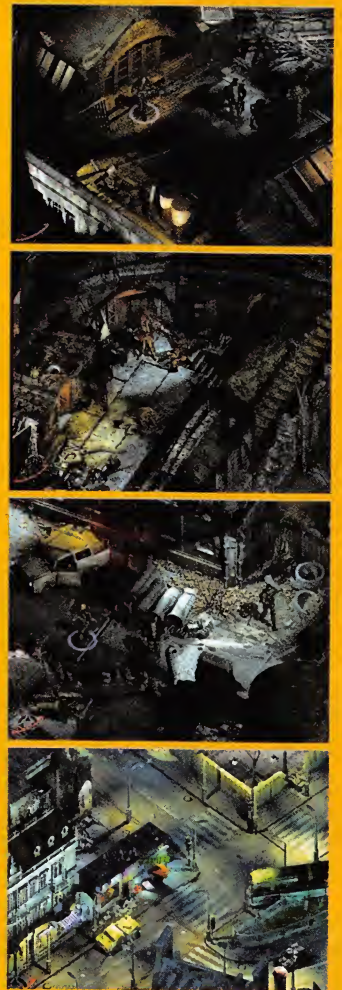

# TACHYON: THE FRINGE

■ Genre: Space Sim ■ Players: 1-Multi ■ Developer: Novalogic ■ Publisher: Novalogic ■ Due: 3rd Qtr 99



Unquestionably it's the hot genre for 1999 (and beyond, if Freelancer is any indication). Quite why this should be the case is a bit of a mystery to us. For years now the space sim has been a reliable, if unspectacular, genre; you could always count on at least one or two gaining release each year. But this year it seems as if everyone has got one. Like Novalogic and Tachyon:



(above) Bloody big space stations. One thing where size does matter.

The Fringe, for instance. In the outskirts of the galaxy, there's a conflict escalating between GalSpan, (nasty! evil!) intergalactic mining corporation, and the Bora, an outlaw group illegally occupying the so-called Fringe. Cast as an independent mercenary (a privateer, dare we say?), you'll be flying missions here and there, attaining a livelihood through trading what you can, dealing with both the Bora and GalSpan in your most impartial manner, but most of all your goal will be to simply stay alive.

What Novalogic hope will set Tachyon apart from the rest of this soon-to-be overcrowded genre is the use of dynamic mini-missions to accommodate a certain amount of variety and replay value. In addition to the twenty main missions, you'll also encounter the opportunity to tackle up to four times as many mini-missions,

the exact nature of which will depend upon how you approach the primary objectives.

Another potentially unique angle concerns the use of wingmen. Novalogic claim that they'll offer you greater assistance than simply increased firepower in combat. Some wingmen you choose will play a vital role in the politics of the game, for example, making it harder or easier to facilitate the numerous deals a mercenary must involve himself in.

What has sparked this resurgence in interest in the space sim is a question we can't answer. However, we will be able to tell you whether or not the resurrection has been worthwhile.





# IMPERIUM GALACTICA 2

■ Genre: Strategy ■ Players: 1-Multi ■ Developer: GT Interactive ■ Publisher: GT Interactive ■ Due: 4th Qtr 99

If you're at all like a certain editor of a certain Australian PC games magazine and not even the sublime empire-building strategy of Birth Of The Federation could overcome your irrational contempt for anything vaguely Trekkie, then you might perhaps be looking for another game to quench your space-bound resource-management desires. Imperium Galactica 2 (the sequel to... nah, you'd never guess) should be added to the list of possible candidates.

In many ways, IG seemed typical of its genre. However, there were several fields in which it attempted to innovate and, in recognition that these weren't all entirely successful, IG2 aims to improve on these further. One such field is its rank-based method of progress. As you journey through the game you gain promotion, your responsibilities increasing along with the number of stripes on your sleeve. Whereas in IG, this meant the end-game bogged down in tedious micro-management, the plan for IG2 is for it to function more appropriately as a learning or difficulty curve. We would speculate that a game could successfully apply this technique by having the player encounter only trivial (but still interesting, of course) missions or situations early in the game, while later on every decision you make has a significant impact on the outcome of the war. With its emphasis on story, IG2 could well achieve something like this.

One criticism levelled at the original IG was that its narrative strength inhibited replay value. Once you'd uncovered the details of the plot, the game lacked a compelling enough reason to play through it again. It was therefore too linear. (Perhaps the plot wasn't at fault, but rather the core gameplay was insufficient. Just a thought - DW). In an attempt to compensate for this, the sequel offers an open-ended

gameplay mode that discards all semblance of story and thus any associated perception of linearity.

It must be said that the story seems to be ripped straight from the annals of hackneyed role-playing. Only this time, instead of the Seven Shards of the Magic Fizzle being lost throughout the kingdom, it's a clutch of memory crystals scattered to all corners of the universe. Containing important but potentially dangerous information regarding genetic research, the crystals are thus highly sought after.

Three distinct races have been envisaged as competitors for these crystals, the Kra'Hen, the Shinari, and the Solarian Empire. As you might expect, the three races differ in crucial aspects; not only in areas of expertise, but in their very role in the story. The Kra'Hen are the warmongers intent upon military domination - they'll take the crystals through sheer force. The



(right) "You say we're searching for these tiny crystals lost somewhere in teh universe? Are you crazy?!"

Shinari are mercenaries, running go-between in all galactic relations - they'll rely on diplomacy and politics. The Solarians are master spies who use infiltration and sabotage to achieve their goals - they'll do anything to get the crystals. Balancing these diverse gameplay styles will prove key to IG2's success.

Elsewhere, we can report that both space battles and terrestrial encounters will feature. The latter occurring in the midst of your base of operations in an effort to more coherently integrate the

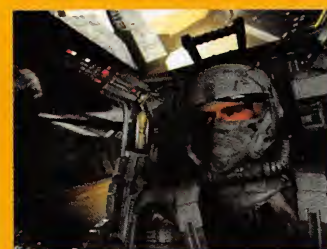

management and combat aspects of the game. One moment you'll be constructing a factory in your colony, the next you'll be frantically defending it from invasion - all on the same game screen.

Ah, all the epic intergalactic conquest you could wish for. And not a Klingon nor Wiggles-suited Starfleet officer in sight!



# VAMPIRE

## THE MASQUERADE - REDEMPTION

■ Genre: Action/RPG ■ Players: 1-Multi ■ Developer: Nihilistic ■ Publisher: Activision ■ Due: 4th Qtr '99

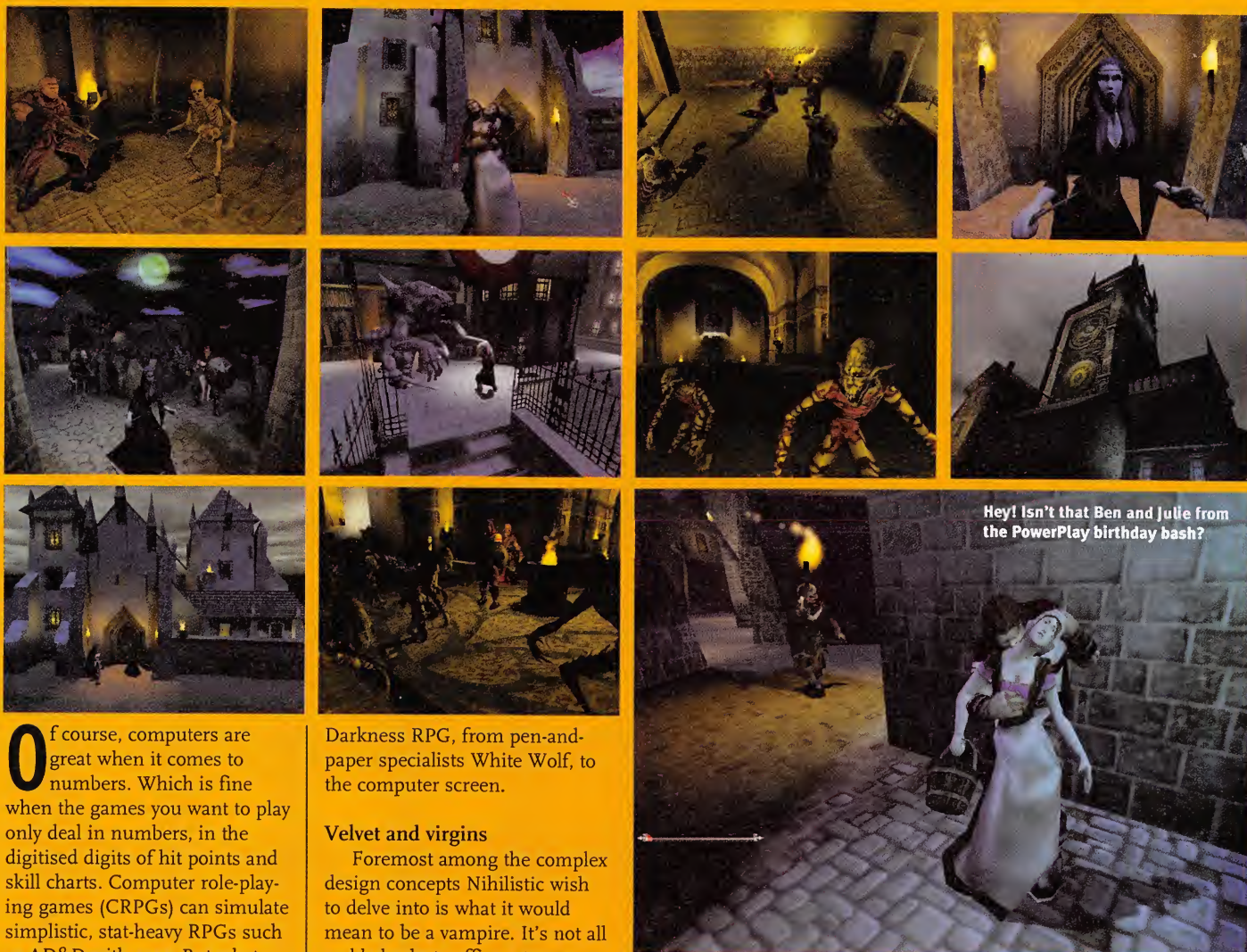

Hey! Isn't that Ben and Julie from the PowerPlay birthday bash?

Of course, computers are great when it comes to numbers. Which is fine when the games you want to play only deal in numbers, in the digitised digits of hit points and skill charts. Computer role-playing games (CRPGs) can simulate simplistic, stat-heavy RPGs such as AD&D with ease. But what happens when the games you want to play require more subtle forms of interaction? A CRPG can calculate dice rolls, but can it evoke emotion and illustrate ambiguity? Such is the dilemma facing Nihilistic Software, developers of Vampire: The Masquerade, as they go about bringing the stat-lite World Of

Darkness RPG, from pen-and-paper specialists White Wolf, to the computer screen.

### Velvet and virgins

Foremost among the complex design concepts Nihilistic wish to delve into is what it would mean to be a vampire. It's not all padded velvet coffins, atmospheric wisps of mist and sucking the blood of pale virgins when you're a member of the Transylvanian undead. The life of a vampire is one of intractable inner torment, of unalleviable anguish. Project Leader, Ray Gresko, commented recently that Vampire is a game of personal horror, where "the role-playing is

much deeper than just upping a strength stat; it's about dealing with what you have become and what that does to your beliefs and morals".

### That's really old

A life spent dedicated to honour and religious servitude as a medieval Christian knight is how that belief and moral system were shaped. The player will assume the role of said knight, Christof Romuald, who at the commencement of the tale is recuperating in Prague after a hard year's crusade. Lead astray from the path of faith and righteousness by a woman (no surprise there, then - except for the

fact that she's a vampire), Christof's world is thrown askew, his vampiric destiny now appearing as one of death and desire. The game is apparently split into two halves - one in 12th century Prague, the other in contemporary London. Spanning some 800 years, Christof's arduous quest will offer him the chance to gain revenge on his immortal foe and, hopefully, see his humanity restored at last. Hey, the game hasn't been subtitled Redemption for nothing, you know.

### Bloodthirsty deeds

Playing as a vampire incurs some strikingly unusual responsibilities for a game character. To



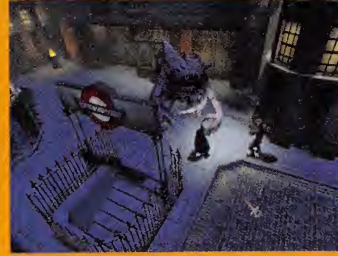
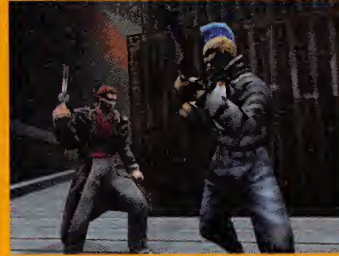
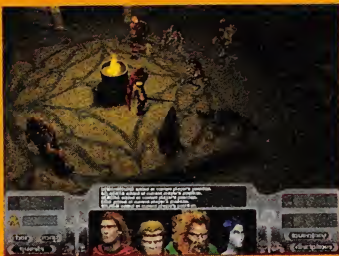

satiate your primal urges, you must ensure Christof ingests a certain amount of blood each day. And, yes, this does entail stalking innocent citizens through the night streets, jumping them at an opportune time and sinking your teeth into their veins. As much fun as this sounds, you must show restraint, as according to Gresko, "if you go around slaughtering people, the vampiric Beast overtakes you and your character becomes unplayable, having lost all humanity."

#### Less guns, more biting please

Vampiric skills appear to be well-catered for with all manner of lycanthropic shapeshiftings afflicting Christof. He has the ability to turn into wolf or to assume gaseous form. Having to use your teeth or claws as a weapon will surely test the interface designers as well as challenge gamers to adapt to something new. Such experimentation should be encouraged in this age of safe, generic titles. In this regard, we must admit that the promised array of contempo-

rary weapons found in the modern-day setting adopted for the game's final chapters is cause for some early concern. Requiem disappointed some gamers with its tired reliance on bog-standard guns at the expense of its far more interesting angelic powers. Hopefully Nihilistic have taken note and these latter stages won't dilute Redemption's uniquely gothic atmosphere.

#### Tell me a story

The multiplayer options intrigue and inspire in equal measure. Added to the soon-to-be-conventional co-operative mode (see also System Shock 2), in which several players will be able to experience the single-player narrative, Nihilistic are incorporating the potential for one player to take on the role of Dungeon Master. In this Storyteller mode, the DM will have the capacity to make changes to the game on-the-fly, as it were, devising a dynamic campaign in much the same way as they could if they were conducting a typical pen-and-

paper RPG. In this regard, perhaps the most surprising (and difficult to implement) possibility is for the DM to assume the role of any NPC the players may encounter during the game.

#### Seamless immersion

Although ostensibly an RPG, Vampire also incorporates a healthy mix of gaming styles into one hopefully seamless package. Stats are hidden behind states of mind, combat resolved thanks to tactics and preparedness as much as keyboard/mouse dexterity, character advancement runs parallel and integral to story advancement; everything indicates that Nihilistic are gearing their game toward completely immersing the player in the gameworld. The final result could well be an experience mediated by as few of the typical anti-immersion aspects of gaming we've yet seen. Whatever, Vampire is a title to treat with the utmost respect. We'd suggest you invest in some garlic and silver crosses right now.

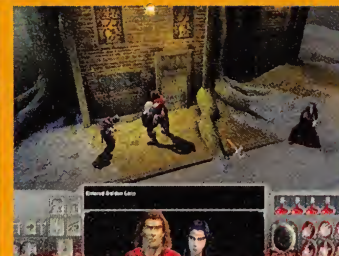
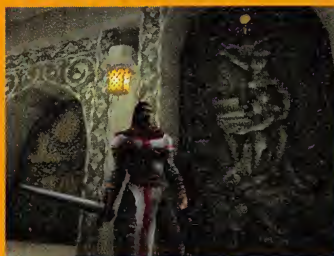

# ATLANTIS 2

■ Genre: Adventure ■ Players: 1 ■ Developer: Cryo Interactive ■ Publisher: Cryo Interactive ■ Due: 4th Qtr '99



Say what you will about the quasi-mystical, tribal bollocks of the setting, you can't deny it makes for some lovely pictures.

**We love Cryo games. Well, actually, we love looking at them.**

**T**empting as it is to trot out the obligatory "Hey, aren't those French a bunch of crazy guys with their crazy games that look eye-explodingly great in a likeably weird way and play mind-implodingly awful in a weirdly likeable way" line when it comes to describing the latest slice of Gallic gaming goodness, we fear that yet another tired rehash of this gross over-generalisation would be unwelcome, not to mention unhelpful. So we'll

try to think of something else for next time, we promise.

Is spiffy a word?

In the meanwhile, however, Atlantis 2 is a spiffy looking adventure that can surely only enhance Cryo's reputation for producing games with a consistently breathtaking visual flair. The original Atlantis - the game, that is, not the legendary

continent lost in the dark, dank, dual depths of both time and the ocean - was itself also a rather spiffy looking adventure that a certain devastatingly eloquent freelancer (Hmm, does such blatant self-congratu-

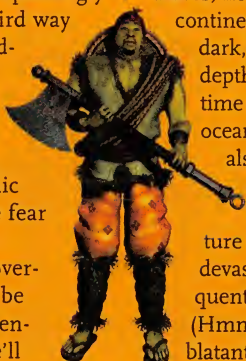

The Pig-in-a-kimono character has been sadly under-used in games over the years.

lation qualify as a sackable offence? - Ed) awarded a not ungenerous score of 73% in PCPP #17. Although gorgeous to an undeniable degree and blessed with some moments of inspired design, it was nonetheless a game that fell short of its potential. Too many silly abstract



puzzles clouded the narrative drive, thus diminishing the exotic atmosphere created by the elegant rendered locales. And so, as is all too often the case with Cryo, the gaming experience was an enjoyable one, despite those nagging thoughts lamenting the



Here you can see the grand entrance to the plush new PowerPlay office in Surry Hills.

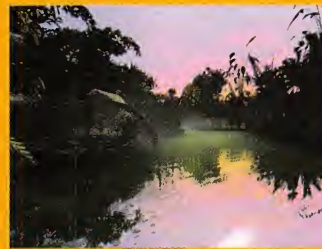

probability that the developers had not spent anything like as much time on the gameplay as on the graphics.

**Here we go!**

All of which brings us neatly to the dilemma facing the writer of any preview of future Cryo products, like this one. Sure, the game is going to look fantastic, but past encounters indicate that this is certainly no guarantee of gameplay quality. So when faced with the abundance of amazement that is Atlantis 2, the trick is to lavish due praise on the visual mastery while conveniently blurring the rest. Here we go, then.

**Moist facials**

Atlantis 2 - Wow! Truly, there's little other way to

describe the initial response to viewing these Atlantean scenes. You can see for yourself just how spectacular are the stunning vistas, how exquisite are the intimate facial close-ups, and how much detail has been inscribed in the environment as a whole. Judging from the evidence we've caught sight of so far, there's no discernible difference in image quality between the cutscenes and the in-game screens. Except, of course, that the cutscenes are fully animated in the most astonishing manner. Simply, these characters move like something we've never seen before in a PC game. The until-now peerless



**The force strikes back**

Actually, we did manage to covertly acquire some plot preliminaries that you may find of interest. In the earlier expedition to Atlantis you stepped



into the role of Seth, a young companion (a guard, in other words) of the Queen of the realm. Now, in a potentially confusing trans-generational, corporate exchange, for the second journey you'll be assuming the persona of Seth's son. The rest of the story concerns an alarmingly Star Wars-esque scenario, with heavy mention of light and dark forces, destinies, quests, and saving the world. The adventurous player will also take in the more scenic aspects of countries such as Tibet, China and Ireland.

But - hey! - that's enough about the plot. Just look at those screenshots and drool, okay?

# CASTROL HONDA SUPERBIKE 2000

■ Genre: Racing sim ■ Players: 1-6 ■ Developer: Midas ■ Publisher: Playcorp ■ Due: Soon

Way back in the dark ages of PCPP # 26, we reviewed a thing called Castrol Honda Superbikes. We gave it 89% too, because we liked it just a bit. It was one of those racing games that seemed insurmountably difficult at first, but which eventually yielded to persistence, delivering the sort of realism that no Moto Racer fan could ever appreciate.

It did have some non-fatal flaws, though, which developer Midas have addressed in the all-new version, which they have cleverly named Castrol Honda Superbike 2000.

This very serious simulation is based on the Honda 190mph RVF-RC45 500cc racing bike. Because this is an officially licensed title, the developers are obligated to state that it's good and realistic. Happily, we can

Varying weather condition also show off the new graphics engine nicely.

Prettiness aside, the new game now features an additional 10 tracks over and above the original 10 included in the first game. Support for playing in Championship mode when playing on a network is another pleasing addition.

3D sound was never properly implemented with the original Castrol Honda Superbikes, so this is an area that naturally got some developer attention. On our test machine, this new 3D effect was evident via our A3D2-based Xitel Platinum Storm. The documentation had no mention of SB Live! support.

Most new racing games feature a replay mode that rivals television for dramatic camera



We cleverly avoid the Racing Game Screenshot Curse by using pics supplied by the developer. Cheers!



report that this is indeed the case. We were provided with a beta version for this preview, and as with the first version of Castrol Honda, we duly came off spectacularly on virtually every corner during our first 30 minutes of racing. It must be realistic, then...

We can certainly say that it looks more realistic. The graphics engine has undergone considerable tweaking, and now features real-time chrome mapping, new particle effects for smokier smoke and dirtier dirt, plus optimisations for those with an SLI Voodoo 2 setup.



angles. The original game fell short in this area, delivering only a crude, one-camera view that abruptly switched after each pan. Now the new game features a proper replay mode with multiple camera angles.

This sim is just around the corner, full review soon.

# IT'S GONNA BE HUGE!



**Climb into the cockpit  
of over 18 Battlemechs**



**Take control of awesome  
firepower with 38 weapons**



**Single player campaigns  
with 20 missions in 4 worlds**



**Multiplayer  
action**

## MECH WARRIOR 3

COMING JUNE 1999



Microsoft



©1999 Hasbro Interactive, Inc. All Rights Reserved. BattleTech Material ©1999 FASA Corporation. MechWarrior, BattleTech, BattleMech and Mech are trademarks or registered trademarks of FASA Corporation. All Rights Reserved. Used under license. All other trademarks are the property of their respective holders.



**MICROPROSE**  
www.microprose.com  
www.mechwarrior3.com

# USAF

■ Genre: Flight Sim ■ Players: 1-16 ■ Developer: Jane's Combat Sims ■ Publisher: EA ■ Due: Now

Many planes in one sim used to mean diluted realism, now EA show us the new way.

There's something about the intro to a Jane's Combat Simulations game that really gets my pulse racing in anticipation... firepower, manoeuvre and shock action! The intro says it, and does it all.

USAF is shaping up to be a hoot of a sim. It will appeal to combat flight simmers of all persuasions, and the menu background music really gets you in the "Top Gun" swing of things by just oozing "action aplenty"!

## Advanced Tactical Fighters II

USAF is the next generation of Advanced Tactical Fighters, US Navy Fighters and most recently Israeli Air Force. In fact, it's being developed for Jane's by the same company that developed IAF. A clear logical and easy to follow menu system that first forces you to log on as your own persona. Name, Callsign and you can even import your own photo to the Pilot File to



There are plenty more aircraft in the air than the flyable ones! Here the B-2 Spirit takes one up the six for not maintaining a stealth profile.



build your character and develop it during your USAF career.

You want aircraft? You got 'em; the F-105, F-4, A-10, F-15C, F-15E, F-16C, F-22, F-117. These eight aircraft span the Vietnam era to the future with the F-105 Thunderchief fighter-bomber

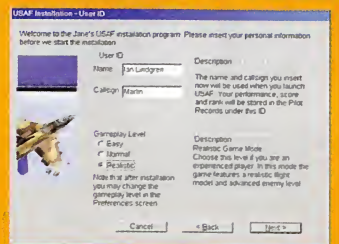

The weapons Loadout Screen is well thought out and easy to use. You can even flick back into the Theatre Situation Display to refresh your Briefing if you need to so you can focus on the load out.

that could do Mach 2 + and was built in the days when faster meant better. The F-4E Phantom interceptor, a beautiful but ungainly bird. The A-10 Warthog, just wait till the A-10 Warthog game is released in the coming months. Two versions of the F-15, the C with its air to air capability, and the E with its strike capability. Then finally, two stealth aircraft. We have plenty of variety here, with each aircraft having its own flight model and very realistic 2D as well as 3D virtual cockpits.

## Love a lush bush

Terrain is one of the things I love about a good sim, and USAF







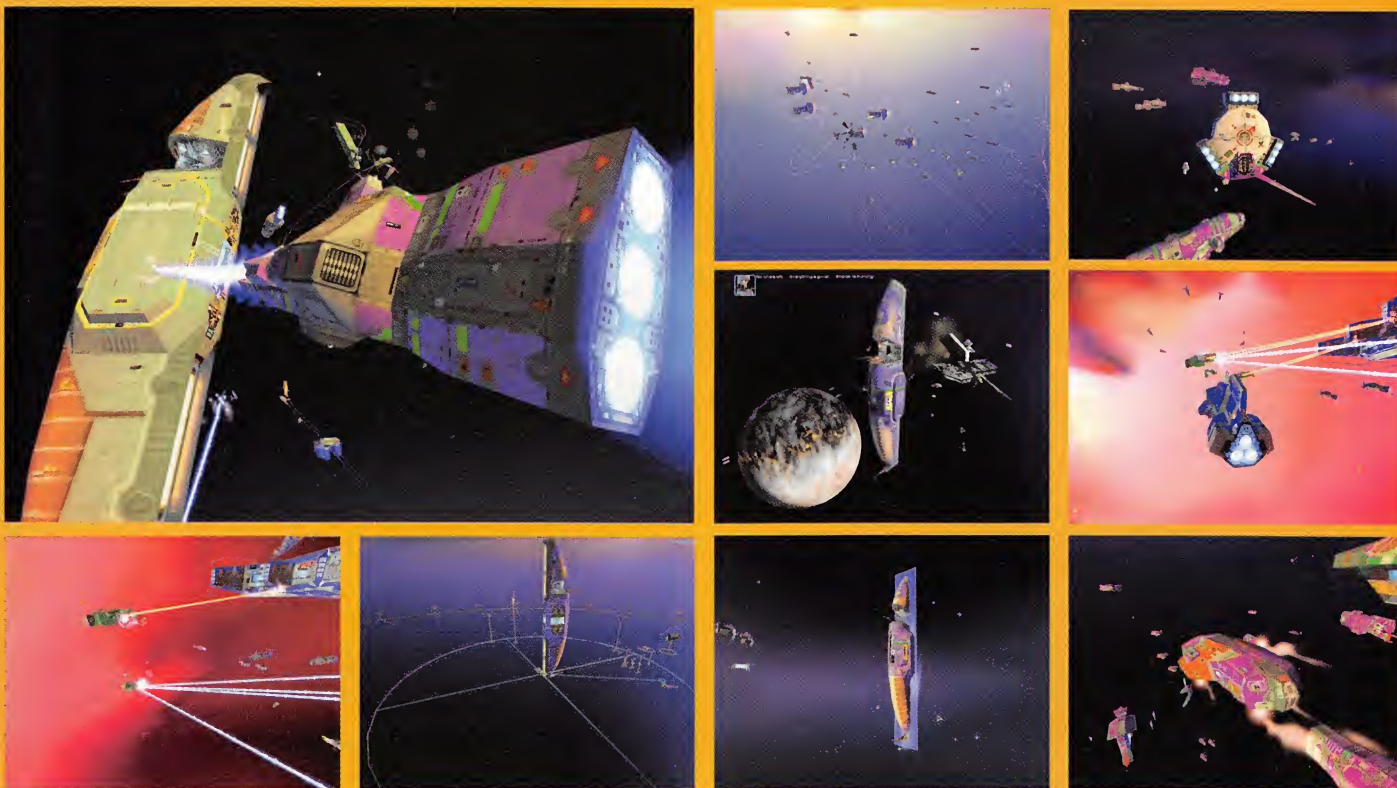

BETA PREVIEW

# HOMEWORLD

■ Genre: Real time strategy ■ Players: 1-multi (TCP/IP, IPX) ■ Developer: Relic Entertainment ■ Publisher: Sierra ■ Due: September '99

Capturing the mystique of the depth and breadth of space, Homeworld is an essential Gaming Experience.

How do you introduce a masterpiece to a gamer? There isn't anything I can say to the Australian gamer that won't be brutally apparent the first time they see Homeworld. This is going to be strategy gaming a step up from the pack. From the powerful and alluring visuals, to



the freedom of excellent, useful control; from the tasteful music to the wonderfully understated "cut scenes", Homeworld looks to be nothing less than extraordinary. Get ready for one monu-

mental gaming experience.

Homeworld is a masterpiece that is not so much a game as an interactive experience. This is economical gaming that lacks the fanfare that so many titles offer these

days. First and foremost, Homeworld offers a simple, resonant story. A humanoid planet finds an ancient spacecraft in the desert that contains a map to a distant star - the Homeworld of their ancestors. The planet unites in the creation of a giant mother-ship to make the journey. The intrigue between two rival factions occurs later... This is an old story done really well - the story of a people looking for their home. Think of the Israelites journey to the Promised Land as just one example of possible inspiration for Homeworld. A parable of sorts, Homeworld is about human nature and endeavour. Sounds a bit heavy but it's really just incredibly captivating and convincing.

### Asimov ambience

The tone of the game is solemn and absorbing. Rather

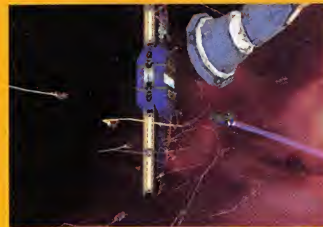

PREVIEWS

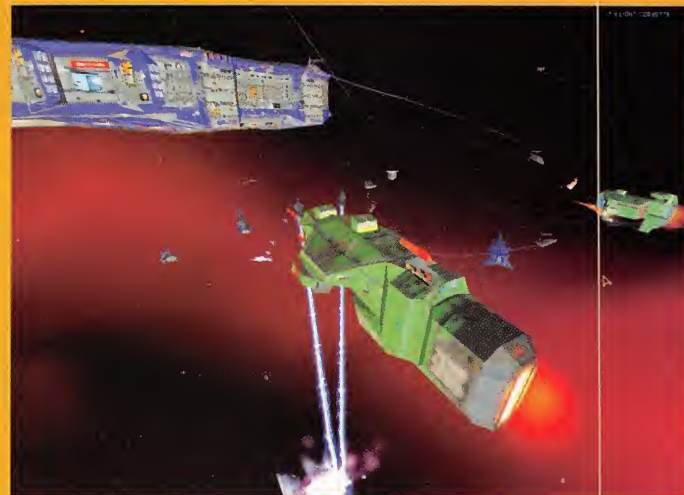

Wow.. Gosh... Ahhh...  
Just some of the reactions we've recorded to Homeworld so far.

than naming any particularly obvious inspirations (like 2001), it's probably more accurate to say that Homeworld has the ambience of science fiction in general from Asimov to Star Trek. The art design is astonishing - there aren't any 3D-rendered awfully-acted characters that look good but not THAT good. Rather you have impeccable clean-line cartoon-style animation that reminds us simultaneously of manga and Tin Tin (if that's possible...). So on the surface it looks to be one first class package.

#### Virtual Vertigo

The game itself involves building and controlling vessels and the maintenance of resources that the mothership requires to continue its journey. The most impressive aspect of Homeworld is the basic game engine. You witness the action from an external camera that floats around the mothership and your various other ships. Wait though, it's not just around - it's also underneath and above. You focus on a specific subject and then have total three dimensional freedom around it. You can zoom right in to hear the distinctive engine rumbling of your scout or resource collector. We can't point out clearly enough how satisfying this point-of-view is in Homeworld.

It's fascinating because it is SO visually satisfying - you'll feel a little vertigo when you pan around moving spacecraft. This camera movement is almost flawless, so that while

you float around a ship it is executing your orders at the same time. This is most convincing in the heat of battle, when many spacecraft are turning, attacking, escaping with next to no slowdown. And this isn't even the final!

Frankly, Homeworld is BEAUTIFUL. It's the little things that stand out: the serene, unsettling space-choir sounds that ooze atmosphere; the low growl of distant engines; the lighting effects in outer space; the voices that crackle over a com link.



#### Fleeting control

The aspect of Homeworld that has the potential to spoil the whole show is control of your fleet, particularly in battle. We are pleased to say that there is nothing to worry about in this regard, since the controls are logical and very well integrated. If you need to use a particular map screen, there is no change in the way you control your fleet and there seem to be no annoying oversights in terms of easy control. Directing crafts in three dimensions is potentially a nightmare but Homeworld does it with ease.

#### Ye olde resource management

The level of detail is extremely satisfying. You have extremely detailed 3D models that can move authentically in a space environment. Homeworld shares with many other strategy games various levels of management. So you have to make sure that you have the resources to build your forces. You need to gather energy to use. You can use this energy to research technology, build various vessels, the usual activities in this type of game. It is however basically a combative game - you build to protect your fleet or attack the enemy.

This is perhaps what causes the most excitement - that there may still be more to do. A Beta version of a game isn't going to be perfect but there isn't anything glaringly wrong with Homeworld as it stands. The frustration of this title being around the corner for much of this year is allayed by the fact that the beta copy we've had for preview is as good as any final reasonably needs to be. Hold onto your spacesuits kids, Homeworld is going to be one incredible ride.

John Dewhurst

# SCORE LIST

## THE COMPLETE POWERPLAY COLLECTION, FROM ABE TO ZORK

GAME	SCORE	ISSUE	GAME	SCORE	ISSUE	GAME	SCORE	ISSUE
101st Airborne	71	#33	ATF Gold	86	#13	Buggy	74	#33
3D Mini Golf	80	#14	Atlantis	73	#17	Burnout Drag Racing: PC	70	#35
3D Ultra Mini Golf Deluxe	60	#30	Atmosphere	55	#2	C&C for Win 95	80	#14
3D Ultra Pinball	77	#21	Atomic Bomberman	72	#16	C&C Sole Survivor	28	#23
3rd Reich	82	#12	Australian Cricket Captain	86	#36	C&C: Red Alert	97	#8
688i Nuclear Sub	90	#16	Azrael's Tear	80	#8	C&C Red Alert: Counterstrike	69	#13
7th Legion	53	#19	Babe Ruth Baseball	60	#17	C&C Red Alert: The Aftermath	70	#19
A-10 Cuba!	65	#11	Baby Slaughter IV	69	#41	Caesar III	88	#31
Abe's Exoddus	86	#32	Back to Baghdad	75	#5	Caesar's Palace	75	#21
Abe's Oddysee	90	#18	Bad Day on the Midway	70	#2	Callahan's Crosstime Saloon	80	#14
Abuse	25	#2	Bad Mojo: the Roach Game	82	#2	Capitalism	40	#2
Acclaim's D	80	#1	Baku Baku	89	#7	Carmageddon	90	#15
Achtung Spitfire	80	#22	Baldur's Gate	87	#35	Carmageddon 2	92	#33
Actua Golf 2	73	#23	Balls Of Steel	89	#23	Cart: Precision Racing	84	#19
Actua Soccer	54	#16	Bass Masters Classic	76	#28	Castrol Honda Superbikes	89	#26
Actua Tennis	84	#32	Battle at Ardenes	86	#17	Cave Wars	72	#12
Adrenix	72	#29	Battle Cruiser 3000AD	78	#12	Championship Manager 2	78	#10
AFL	62	#10	Battle of Britain	62	#38	Championship Manager 3	85	#38
AFL 98	94	#19	Battleground 8: Waterloo	78	#22	Chaos Overlords	64	#3
AFL 99	90	#34	Battleground Antietam	83	#11	Chasm: The Rift	60	#19
Afterlife	81	#5	Battleground Ardenes	67	#2	Chess Master 4000 Turbo	86	#3
Age of Empires	93	#17	Battleground Bull Run	75	#15	Chess Wars	70	#15
AOE: Rise of Rome	90	#33	Battleground Napoleon	75	#15	Chronicles of the Sword	48	#3
Age of Sail	79	#13	Battleground Shiloh	84	#6	City of Lost Children	74	#12
Agent Armstrong	68	#16	Battleground Waterloo	67	#4	Civ 2 Fantastic Worlds	68	#21
AH-64 Flashpoint Korea	92	#11	Battleship	71	#15	Civ 2: Multiplayer + classic	90	#28
AH-64D Longbow	86	#3	Battlespire	54	#30	Civilization: Call To Power	96	#36
Air Warrior II	73	#12	Battlezone	90	#22	Civil War	84	#8
Air Warrior III	92	#22	Beast Wars	43	#26	Civil War 2: Generals	81	#22
AI Unser Jr Arcade Racing	40	#3	Beasts and Bumpkins	92	#18	Civilization 2	90	#1
Albion	70	#8	Beat The House 2	76	#23	Claw	62	#26
Alien Earth	54	#27	Beavis and Butthead	68	#36	Close Combat	72	#5
Alien Incident	86	#6	Bedlam	68	#8	Close Combat 2	90	#18
Alien Trilogy	51	#10	Betrayal at Antara	71	#16	Close Combat 3	88	#35
Alien Virus	69	#5	Beyond Time	50	#30	Cluedo	71	#34
Aliens vs. Predator	96	#36	Big Hurt Baseball	79	#5	Clyde's Revenge	69	#6
Alpha Centauri	96	#36	Big Race Pinball	90	#33	Colin McRae Rally	94	#30
American Civil War	53	#5	Big Red Racing	67	#2	Comanche 3	80	#14
Amok	79	#8	Bio Freaks	72	#28	Comanche Gold	85	#27
Anastasia	20	#27	Birthright	79	#17	Combat Chess	70	#20
Ancient Conquest	79	#35	Black Dahlia	82	#24	Commandos	82	#28
Ancient Evil	72	#26	Blackstone Chronicles	75	#36	Commandos: Call of duty	83	#38
Andretti Racing	77	#21	Blade Runner	96	#19	Complete Carriers at War	61	#2
Apache Havoc	84	#34	Blood	71	#14	Conquest of the New World	71	#2
Apache Longbow Gold	92	#13	Blood 2	72	#34	Constructor	84	#15
Arc of Time	75	#11	Blood and Magic	86	#9	Constructor: Street Wars	74	#39
Archimedean Dynasty	90	#9	Blood Plasma	55	#21	Creatures	85	#8
ARL Rugby League 96	88	#4	Blue Ice	77	#10	Creatures 2	86	#31
Armor Command	86	#25	Boss Rally	5	#39	Cricket 97	87	#17
Armoured Fist 2	82	#20	Brainstorm	43	#9	Cricket World Cup '99	93	#38
Army Men	85	#29	Breakneck	86	#39	Croc	74	#22
Army Men 2	79	#38	Bridge Deluxe 2	85	#4	Crusader: No Regret	95	#7
Asghan	43	#36	Broken Sword	89	#6	Curse of Monkey Island	92	#21
Assassin 2015	55	#8	Broken Sword 2	80	#19	Cyber Judas	43	#5
Assault Rigs	50	#1	Bud Tucker	70	#3	Cyberball	6	#29
Asteroids	74	#33	Bug	53	#9	Cyberstorm	91	#3
						Cyberstorm 2	68	#28
						Cyberstrike 2	83	#34
						Daggerfall	83	#8
						Dark Colony	60	#18
						Dark Earth	91	#19
						Dark Reign	94	#14
						D.Reign: Rise of Shadowhand	80	#25
						Dark Seed 2	80	#3
						Dark Side of the Moon	47	#36
						Dark Vengeance	30	#36
						Darklight Conflict	89	#14
						Davis Cup Tennis	17	#10
						Dawn of Aces	72	#36
						Daytona	60	#10
						Daytona USA Deluxe	25	#19
						Deadline	66	#5
						Deadlock	74	#6
						Deadlock 2	78	#23
						Death Rally	83	#11
						Deathkeep	30	#4
						Decathlon	20	#6
						Deer Hunter 2	55	#32
						Delta Forces	91	#33
						Descent 2	90	#1
						Descent 2 Infinite Abyss	89	#16
						Descent 3	95	#38
						Descent To Undermountain	31	#23
						Descent: Freespace	93	#27
						DF: Silent Threat	80	#32
						Destiny	37	#10
						DethKarz	85	#31
						Deus	72	#11
						Diablo	91	#11
						Diablo: Hellfire	87	#22
						Die by the Sword	92	#25
						DBTS: Limb From Limb	79	#32
						Die Hard Trilogy	80	#13
						Dinotopia	55	#3
						Discworld 2	88	#10
						Discworld Noir	83	#39
						Dog Day	82	#13
						Dominion Storm	55	#31
						Dragon Dice	71	#17
						Dreams to Reality	71	#19
						Duckman	73	#18
						Duke 3D Plutonium Pack	80	#16
						Duke Nukem 3D	90	#3
						Dune 2000	87	#28
						Dungeon Keeper	85	#16
						Dungeon Keeper: Deeper	60	#22
						Earth 2140	86	#16
						Earthsiege 2	85	#2
						Eastern Front	75	#22
						Eastern Front II	85	#39
						Echelon	15	#31
						Ecstatica 2	86	#12
						Egypt 1156 BC	77	#26
						Eidos Official F1	65	#39
						Elk Moon Murder	65	#5
						Enemy Infestation	76	#30
						Enemy Nations	69	#17
						Entrepreneur	81	#22
						Episode 1 Racer	90	#39
						Euro 96	85	#4
						European Air War	94	#31
						Everquest	90	#39
						Evidence	49	#20
						Extractors	30	#5
						Extreme Assault	88	#17
						Extreme Games	60	#1
						Extreme Tactics	61	#27
						F-16	80	#17
						F-22 Lightning 2	80	#8
						F-22 Raptor	74	#22
						F/A-18 Hornet 3.0	78	#16
						F1 Manager	75	#8
						F1 Racing Sim	79	#22
						F16: Aggressor	69	#32
						F22 ADF	87	#21
						F22 ADF: Rea Sea	85	#27
						FA/18 E Carrier Strike Fighter	86	#30
						Fable	46	#10
						Falcon 4.0	98	#33
						Fallen Haven	71	#13
						Fallout	89	#18
						Fallout 2	88	#32
						Fantasy General	82	#2
						Fatal Abyss	62	#33
						Fields of Fire	53	#29
						FIFA 97	69	#10
						FIFA 98	95	#20
						FIFA 99	92	#32
						FIFA Soccer Manager	71	#16
						Fighter Pilot	71	#32
						Fighter Squadron	85	#36
						Fighting Force	70	#23
						Final Conflict	20	#24
						Final Doom	82	#6
						Final Fantasy VII	90	#27
						Firefight	82	#5



**Gold Award - Games scoring 90-94%**

**Platinum Award - Games scoring 95-100%**

GAME	SCORE	ISSUE
Fleet Command	89	#39
Flight Unlimited 2	89	#22
Flipout	73	#14
Flying Corps	76	#11
Flying Corps Gold	74	#20
Forbidden City	74	#32
Fork in the Tale	58	#13
Formula 1 3Dfx	77	#12
Formula Karts	84	#19
Forsaken	93	#25
FPS: Skiing	63	#24
Fragile Allegiance	85	#10
Front Page Sports Golf	77	#18
Full Court Press	82	#7
G-Name	80	#15
G-Police	92	#18
Galapagos	77	#19
Gangsters	85	#34
Gender Wars	72	#4
Gene Wars	86	#8
Get Medieval	61	#30
Gettysburg	80	#1
Gex	80	#7
Gex 2: Enter the Gecko	87	#28
Global Domination	63	#32
Golf Pro 2000	65	#12
Goosebumps	79	#10
Grand Prix 2	90	#1
Grand Prix Legends	95	#30
Grand Theft Auto	65	#18
GTA London	75	#38
Grand Touring	60	#35
Great Battles of Alexander	80	#17
Great Battles of Hannibal	62	#23
Grim Fandango	91	#31
Gruntz	45	#36
Half Life	98	#31
Hang Time	79	#11
Hard War	59	#29
Harpoon 97	90	#10
Heart of Darkness	89	#27
Heaven's Dawn	25	#6
Heavy Gear	91	#20
Hedz	69	#32
Helicops	79	#15
Hell Bender	54	#7
Heretic	50	#3
Heretic 2	91	#34
Heroes of Might and Magic II	88	#10
Heroes of Might and Magic III	94	#35
Hexen	90	#3
Hexen 2	91	#18
Hexen 2: Portal of Praevus	78	#27
Hexplode	75	#28
Hind	84	#9
Holy Casino	71	#10
House of the Dead	59	#28
Howzat	2	#22
Hoyle Casino '98	73	#22
Hunter Hunted	70	#10
Hyperblade	89	#8
I Have No Mouth and...	79	#3
I-War	89	#21
IF-22	65	#17
Ignition	81	#18
Imperialism	81	#21
Imperialism 2	72	#36
Imperium Galactica	80	#14
In Pursuit of Greed	70	#5
Incoming	67	#24
Incubation	84	#19
Independence Day	85	#13
Indy Racing	64	#28
Int. Rally Championship	79	#21
International Cricket Captain	91	#28
Interstate '76	93	#12
Interstate '76 Arsenal	78	#25
Into the Void	86	#14
Isis	32	#3
Israeli Air Force	90	#34
Jack Nicklaus 5	89	#21
Jack the Ripper	46	#6
Jagged Alliance 2	83	#7
Jane's A.T.F.	72	#2
Jane's F-15	85	#25
Jedi Knight	95	#18
JK: Mysteries of the Sith	93	#23
Jet Fighter 3	85	#10
Jet Fighter 3: Mission Disk	85	#15
Jet Moto	72	#22
Jetfighter: Full Burn	67	#32
Jimmy White's Cueball 2	67	#38
Johnny Herbert's Grand Prix	91	#30
Joint Strike Fighter	85	#20
Jonah Lomu Rugby	45	#20
Journeyman Project 3	69	#22
Judge Dredd Pinball	82	#30
Karma	20	#2
King's Quest 8	85	#34
Kingdom of Magic	69	#4
KKnD	90	#7
KKnD 2: Krossfire	65	#28
KKnD Extreme	70	#19
Klingon Honour Guard	84	#31
Knights and Merchants	81	#32
Krazy Ivan	57	#9
Lander	95	#36
Lands Of Lore 2	92	#17
Lands of Lore 3	60	#38
Last Bronx	70	#24
Legacy of Kain	65	#18
Legal Crime	77	#23
Lighthouse	88	#8
Links 99	86	#32
Links LS	90	#6
Longbow 2	88	#21
Lords of Magic	74	#23
Lords of the Realms 2	84	#10
Luftwaffe Command	68	#35
Lunatics	61	#14
M.A.X. 2	81	#30
M1 Tank Platoon	91	#25
M1A2 Abrams	80	#13
Madden 98	81	#20
Madden NFL 97	84	#8
Madden NFL 99	88	#32
Machines	90	#38
Mage Slayer	64	#20
Magic the Gathering: Spec. Ed	69	#25
Magic: The Gather-MicroProse	91	#12
MTG: Spells of Ancients	70	#21
Magic: The Gathering-Acclaim	71	#12
Man of War	71	#18
Manx TT	44	#23
Mass Destruction	78	#17
Master Levels for Doom 2	30	#1
Master of Orion 2	92	#10
Mastermind	71	#26
Maximum Roadrage	32	#6
MDK	83	#12
Meat Puppets	71	#16
Mech Commander	86	#27
Mechwarrior 2: Mercenaries	85	#7
Mechwarrior 2: Titanium	86	#26
Mechwarrior 3	91	#39
Mega Race 2	69	#7
Metal Storm	25	#10
MIA	65	#34
MIB	78	#20
Micro Machines v3	80	#29
Microsoft Combat Flight Sim	89	#33
Microsoft Golf 99	80	#36
Might & Magic VI	91	#26
Mini and the Mites	78	#6
Monaco Grand Prix	74	#32
Monopoly: World Cup 98	45	#26
Monster Truck Madness	77	#7
Monster Truck Madness 2	82	#26



Monster Trucks	59	#19
Montezuma's Return	42	#32
Monty Python's Meaning of Life	57	#25
Moon Buggy 98	81	#18
Mortal Kombat 4	80	#30
Moto Racer	94	#16
Moto Racer 2	86	#30
Motocross Madness	94	#30
Motorhead	83	#26
MS Flight Sim v6	83	#10
MS Football	36	#10
Mummy	65	#10
Muppet Treasure Island	62	#5
Myth 2	91	#35
Myth: The Fallen Lords	93	#20
Nascar 2	76	#11
Nascar Truck	80	#38
NBA Action 98	85	#23
NBA JAM	39	#14
NBA Live 98	88	#20
NBA Live 99	86	#31
NCAA Final Four '97	74	#12
Necrodome	70	#10
Need For Speed 2	90	#13
Need for Speed 2 SE	80	#21
Need for Speed 3	79	#28
Need for Speed SE	56	#5
Netmech	60	#6
Netstorm	85	#20
Newman Haas Racing	70	#33
NHL 98	90	#19
NHL 99	73	#31
NHRA Drag Racing	68	#32
Nightlong	79	#31
Nightmare Creatures	79	#27
Nine	84	#9
Noir	61	#12
Normality	78	#4
Norse by Norsewest	72	#12
North vs. South	67	#36
Novalogic F16 + MiG 29	90	#32
Nuclear Strike	85	#20
Obsidian	81	#15
Of Light and Darkness	60	#26
Offensive	35	#4
Olympic Games 1996	44	#6
Onside	35	#4
Orion Burger	76	#11
Outlaws	78	#13
Outpost 2	68	#18
Outwars	85	#26
Over The Reich	70	#12
Overboard	79	#19
Pacific General	82	#17
Pandemonium 2	20	#30
Panzer Commander	58	#27
Panzer General 2	82	#21
Paris French Open	72	#18
Pax Imperia	65	#21
Perfect Assassin	80	#19
Phantasmagoria 2	81	#11
Pilgrim	46	#26
Pinball Soccer	72	#33
Plane Crazy	70	#26
POD	74	#11
Populous: The Beginning	86	#32
Postal	38	#18
Power Chess	83	#10
Power F1	69	#11
Powerboat Racing	70	#25
Powerslide	93	#32
Premier Manager 97	54	#16
Privateer 2: The Darkening	89	#8
Pro18 World Tour Golf	69	#38
Pro Pilot	62	#23
Puma World Football 98	33	#20
Quake	92	#6
Quake: Armagon	85	#12
Quake: Eternity	72	#12
Quake 2	94	#21
Q2: The Reckoning	82	#27
Q2 Mission Pack: Ground Zero	87	#30
Queen: The Eye	60	#25
Quest for Glory V	90	#34
Radix	68	#7
Railroad Tycoon 2	91	#33
Rainbow 6	91	#30
Rainbow Six: Eagle Watch	86	#36
Rally Challenge	84	#9
Rally Championship	81	#7
Rama	86	#10
Rayman	92	#3
Reah	78	#32
Realms of the Haunting	91	#11
Red Baron 2	92	#23
Red Baron 3D	87	#34
Redguard	78	#35
Redjack	70	#31
Redline	83	#36
Redline Racer	78	#24
Redneck Deer Hunting	16	#30
Redneck Rampage	77	#14
Redneck Rampage Rides Again	48	#26
Redneck Rampage: Route '66	64	#22
Requiem - Avenging Angel	90	#38
Resident Evil	74	#19
Resident Evil 2	88	#36
Return Fire	69	#4
Return Fire 2	72	#32
Return of Arcade	70	#5
Return to Krondor	79	#34
Ripper	70	#1
Risk	84	#15
Riven	90	#19

# SCORE LIST

GAME	SCORE	ISSUE
Riverworld	65	#31
Road Rash	80	#8
Rocket Jockey	68	#15
Rogue Squadron	82	#33
Roland Garros	85	#32
Rollcage	90	#38
Rollercoaster Tycoon	93	#36
Ruthless.com	82	#35
S.C.A.R.S.	64	#31
Sabre Ace	82	#18
Safe Cracker	49	#24
Sand Warrior	68	#16
Scarab	81	#13
Screamer 2	81	#8
Sega Rally	72	#11
Sega Touring Car Champ.	29	#23
Semper Fi	50	#24
Sentient	68	#14
Sentinel Returns	84	#27
Settlers 2	87	#3
Settlers 2 Mission Disk	67	#12
Settlers 3	88	#33
Seven Kingdoms	87	#21
Shadow Master	70	#24
Shadow Warrior	80	#18
Shadows of the Empire	80	#18
Shadows Over Riva	84	#15
Shane Warne Cricket	86	#36
Shanghai Dynasty	75	#22
Shattered Steel	86	#8
Shellshock	40	#6
Sherlock Holmes	90	#9
Shivers 2	52	#14
Shogo: MAD	84	#32
Shrak Quake	40	#16
Sid Meier's Gettysburg	92	#20
Silent Hunter	74	#2
Silent Thunder	72	#2
Silver	84	#36
Sim City 3000	90	#35
Sim Copter	71	#10
Sim Safari	60	#25
Sin	84	#32
Sin - Wages of Sin	73	#38
SlamTilt	68	#12
Snow Wave Avalanche	60	#33
SODA Offroad Racing	75	#22
Solar Crusade	26	#18
Soldier Boyz	12	#29
Soldiers at War	80	#27
Sonic and Knuckles	76	#13
Space Bunnies Must Die	74	#31
Space Hulk	74	#5
Spearhead	89	#30
Spec Ops: Ranger Assault	84	#28
Speed Rally	89	#21
Speedboat Attack	30	#19
Speedbusters	91	#36
Spiderman: The Sinister Six	49	#11
Spycraft: The Great Game	90	#1
Star Command	80	#14
Star Control 3	77	#8
Star Rangers	57	#2
Star Trek Academy	92	#17
Star Trek Borg	71	#13
Star Trek: BOTF	90	#39
Star Trek Generations	83	#13
Star Trek Pinball	76	#25
Star Trek: Deep Space Nine	64	#2
Star Wars: Rebellion	88	#24
Starball	45	#2
Starcraft	92	#25
Starcraft Insurrection	79	#29
Starcraft: Brood Wars	87	#35
Starcraft: Retribution	71	#34
Stars!	89	#11
Starship Titanic	71	#24
Starsiege	90	#36
Starsiege Tribes	88	#35
Steel Panthers	84	#21
Steel Panthers add-on disk	75	#6
Stratosphere	82	#28
Street Fighter Alpha 2	69	#27
Streets of Sim City	30	#21
Strife	68	#6
SU-27 Flanker Mission Disk	88	#18
Sub Culture	82	#19
Super EF2000 Tactcom	92	#11
Super Stardust	89	#6
Superbike World Champ.	91	#34
Surface Tension	15	#9
Swat 2	75	#29
SWIV	82	#9
Syndicate Wars	91	#9
Take No Prisoners	81	#19
Tanarus	85	#22
Team Apache	83	#28
Tempest 2000	90	#1
Terminator: Future Shock	90	#1
Terminator: Skynet	94	#12
Terracide	65	#17
Terranova	91	#2
Test Drive Off Road	70	#13
Tex Murphy: Overseer	89	#24
TM: The Pandora Directive	93	#6
The Creed	86	#29
The Feeble Files	73	#19
The Fifth Element	80	#31
The Golf Pro	87	#24
The Last Express	88	#13
The Martian Chronicles	48	#9
The Neverhood	93	#9
The Phantom Menace	76	#39
The Reap	76	#23
The Ring	54	#33
The Tone Rebellion	80	#19
The X-Files	76	#27
Theme Hospital	90	#12

## ONE YEAR AGO... Spec Ops



Thief: Dark Project	95	#33
Thrust, Twist & Turn	30	#39
Thunder Brigade	79	#35
Tiger Woods 99	79	#31
Tigershark	74	#15
Time Commando	93	#5
Time Lapse	80	#9
Titanic	74	#10
TOCA Touring Cars	94	#20
TOCA 2	91	#36
Tom Clancy SSN	75	#15
Tomb Raider	94	#9
Tomb Raider 2	86	#19
Tomb Raider 3	88	#33
Tomb Raider: Unfinished Bus.	68	#26
Top Gun: Fire At Will	60	#1
Top Gun: Hornet's Nest	65	#34
Torin's Passage	50	#1
Total Air War	92	#31
Total Annihilation	98	#18
TA: Commander	86	#34
TA: Core Contingency	90	#26
Total Mayhem	64	#3
Trespasser	60	#33
Triple Play 97	63	#5
Triple Play 98	82	#16
Triple Play 99	87	#26
Trophy Bass	72	#28
Trophy Bass 2	40	#25
Turok 2	54	#33
Turok Dinosaur Hunter	89	#20
Twinsen's Odyssey	84	#15
Twisted Metal 2	84	#22
Tyrian	54	#7
UEFA 98/99	71	#38
U.F.O.	73	#29
Ubik	81	#24
Ultimate Race Pro	68	#23
Ultimate Soccer Manager 2	72	#12
Ultra Violent Worlds	30	#29
Unreal	98	#26
Unreal Tournament	94	#39
Uprising	89	#22
Uprising 2	58	#36
Urban Assault	81	#29
USCF Chess	71	#23
V2000	45	#33
Vangers	53	#29
Vegas Games	60	#14
Versailles	81	#11
Viper Racing	80	#34
Virtua Cop	82	#10
Virtua Cop 2	78	#21
Virtual Deep Sea Fishing	63	#38
Virtual Pool 2	93	#19
Virtual Snooker	80	#2
Voodoo Kid	79	#18
Voyeur 2	20	#5
VR Sports Baseball 97	91	#21
W. Gretzky & NHLPA Allstars	20	#1
Wages of War	65	#11
War College Simulator 3	57	#6
War Games	68	#29
War Gods	70	#18
War of the Worlds	70	#34
Warbirds 2	81	#36
Warbreeds	54	#26
Warcraft 2: 70 Levels	63	#12
Warcraft 2: Dark Portal	60	#3
Wargasm	80	#32
Warhammer 40K	88	#22
Warhammer: Dark Omen	88	#25
Warlords 3	89	#16
Warlords 3: Darklords	89	#29
Warwind 2	54	#22
Warzone 2100	88	#38
Water World	56	#19
WCW Nitro	52	#35
Wetrix	40	#31
Wing Commander Kilrathi	82	#9
Wing Commander Prophecy	90	#22
Wipeout 2097	75	#14
Witchhaven 2	59	#4
Wizardry	80	#9
Wizardry Gold	52	#4
Wolfenstein 3D	100	#25
Wooden Ships and Iron Men	71	#13
World Cup 98	84	#27
World League Basketball	58	#26
World League Soccer 98	85	#26
World Rally Fever	68	#4
Worms 2	90	#19
Worms Armageddon	83	#36
Worms Reinforcements	84	#5
Wreckin' Crew	27	#29
Wrestlemania	80	#5
WWII Fighters	92	#33
X-Wing Alliance	94	#36
X-Wing vs. TIE	93	#13
X Wing vs. TIE: Balance Power	83	#22
X-Car	61	#20
X-COM: Apocalypse	93	#15
X-COM: Interceptor	77	#27
Xenocracy	68	#28
XS	71	#9
Yoda Stories	74	#12
You Don't Know Jack XL	94	#2
You Don't Know Jack: Movies	88	#14
Z	72	#6
Zombie Wars	69	#13
Zork Grand Inquisitor	96	#20
Zork Nemesis	86	#2

## ONE YEAR AGO... Stratosphere



Total Annihilation: Kingdoms .....	64
Heavy Gear 2 .....	68
Midtown Madness .....	72
Sports Car GT .....	78
Mike Stewart's Pro Bodyboarding.....	80
Outcast .....	82
Saga: Rage of the Vikings .....	84
F-22 Lightning III .....	86
Corsairs .....	88
Might and Magic VII .....	90
Anno 1602 .....	94
Man of War 2.....	96



**PAGE 68**  
Heavy Gear II



**PAGE 90**  
Midtown Madness



**PAGE 90**  
Might & Magic 7



**PAGE 64**  
TA: Kingdoms

## A small, but choice collection

“It’s like a cross between Shogo: MAD and Mechwarrior! It’s brilliant!” exclaimed a joyful Ashton, when I called to find out what he thought of Heavy Gear 2. “Tops, what about TA: Kingdoms?” I wondered next. “Ohh, it’s alright...”, spake Ash. WHAT!? This from the man who awarded the original Total Annihilation a whopping 98% back in PCPP #18. A few days later, when I had secured my own copy, what Ash said made sense. A fine game, is TA: Kingdoms, but just a little on the ordinary side, sadly. It also needs a PC yet to be invented to run smoothly, forging on with the less than fine tradition established by the original TA. Oh well, there’s always Warcraft...

Considerably more fun is to be had with Midtown Madness, from Bill & Co. That such a subversive game could come from the House of Conservative

is somewhat amazing. Take one real car, dump it in the middle of a real city, and hand over the controls to your average gamer, brimming with unrestrained anarchistic tendencies, and all you can reasonably expect is a mass of flattened pedestrians and toppled streetlights. Top fun! Except you can’t actually flatten the passers-by - Microsoft have endowed them with mystical acrobatic skills, such that they avoid you every single time. That’s just Microsoft being ‘proper’ about it all, but it hardly diminishes the big fun that’s to be had with this winner of a game.

And a whole bunch more. But do read on and soak up our collective expertise, because that’s what we do, it gives our otherwise worthless lives meaning and purpose. I feel a bad mood coming on, better go for a drive...

**Ben Mansill**  
Editor, PC PowerPlay

### THE PC POWERPLAY SCORING SYSTEM

95%+	<b>PLATINUM</b> The Best. Virtually faultless, reserved for games which cause loss of sleep from thinking of nothing else.
90-94%	<b>GOLD</b> A classic. Either an unquestionable example of superiority within its genre, or a ground breaking game that’ll be setting trends.
80-90%	A strong, eminently playable game. Hard to fault and likely to still be on the hard drive in 6 month’s time.
60-80%	Competent and generally enjoyable. Flaws or mediocrity hold these games back from higher ratings.
40-60%	Average and ordinary. Not bad, not good. Ideal gift.
0-40%	Bad, really bad. Boring, shamelessly unoriginal, cheap and horrible.

# TOTAL ANNIHILATION: KINGDOMS

Genre: Real time strategy | Players: 1-8 | Developer: Cavedog | Publisher: GT Interactive | Price: \$TBA | Rating: G | Available: Now

Will Kingdoms take over from Total Annihilation as the new king of the RTS genre? Err... nope.

Ever since Total Annihilation redefined the RTS genre, TA:Kingdoms has been one of the most anticipated gaming titles in our short and fanatical gaming history. Gamers everywhere have been waiting to see what more

Cavedog could do to an already brilliant game engine, and what new features the successful company could add to improve gameplay further.

Kingdoms is finally here and, er, it's not quite what everyone expected. Rather than expand and add to the original TA style gameplay, the rule of thumb for Kingdoms is consolidation. Lots of it. To the same degree that the engine has been graphically enhanced the depth of gameplay has been reduced. Less is more, according to Cavedog, but it's a pity this doesn't apply to the system requirements as well.

## Where's the beef?

First impressions of Kingdoms are positive. You have the option of playing in resolutions ranging from 640x480 up to 1920x1200, and if you've got some 3D beef in your machine you get to take advantage of nifty new features such as shadows and fog. Pretty good, really.

This change to support 3D hardware is worth noting - many TA players lobbied



Fire-breathing dragons versus spindly wooden ships. Is this really a fair fight?

Cavedog to take advantage of 3D hardware in TA to improve frame rates in high resolutions or in large scale battles. Cavedog's response was that taking advantage of 3D hardware would barely yield an improvement, since the game relies almost solely on CPU grunt to generate the graphics. It seems that in Kingdoms Cavedog has changed its mind, but only in so far as taking advantage of 3D hardware effects. The effects are nice, but be assured that CPU power is more important if smooth gameplay is your goal.



## Amazing detail

Cavedog have spent quite a while enhancing the original TA engine for Kingdoms. As with the original, all units are rendered in real time, giving that same classic style TA look where units can be drawn to any angle, and move and fight with perfect fluidity. This time around the detail on the units is amazing - finer detail, rich colours, smooth animation, and, as units gain experience, they even start to look different. Sounding better and better isn't it?



## Demanding bed-fellows

But here's the catch. It's not terribly fast. You'll need some serious beef to run Kingdoms nicely, and I'm not talking quarter pounder beef here, I'm talking hulking big fat cow type of beef. This die hard TA fan currently uses a PII 450 128M RAM TNT based machine, and where most games wet themselves on this setup, Kingdoms was eyeing it up and down and saying 'Umm, got any more?'

The unit animation, while gorgeous, isn't as smooth as it

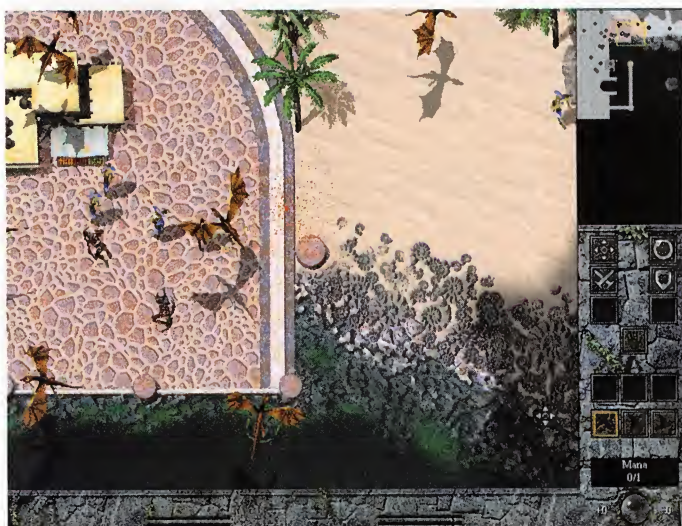



# WELCOME TO DARIEN



The background story details the mythical world of Darien, once ruled by a godly sort of chap, and before his mysterious disappearance he imparted powerful artifacts to each of his four children that ruled all of Darien. Each artifact represented one of the four elements of earth, air, water and fire. The game begins a few hundred years after the disappearance of its king at a time where the four siblings are starting to vie for control of the four continents of the world, two of them aligning with moral lines of good, and two with evil. All up, it was a four way warlordish power game just conveniently waiting to happen.



## Earth

Aramon, representing earth, has units that consist of traditional swordsmen, archers, knights and the like. Aramon is ruled by king Elsin, and if you favour traditional knights in shining armour troops, this is your guy. King Elsin doesn't believe much in the use of magic, so this side is really your stable, rock solid type of play. Special mention should be made of the Trebuchet, which acts much like a mini Bertha. Nice.

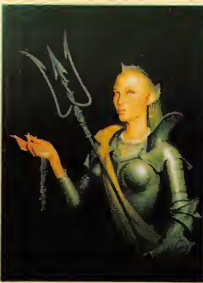

## Water

Veruna, representing water, focuses on the seas with a variety of naval units and even a water based construction building. Ruled by the sea mage Kirenna, Veruna is an interesting side to play due to the mix of its units. While it has a strong naval component, it also has quite capable land units and even the odd air unit. A good defensive side to play.



## Air

Zhon, representing air, has its strength in the variety and numbers of its varied creatures. Ruled by the huntress Thirsha, there are no fixed buildings to create with Zhon, rather the construction units double as troops. Think of this as a mobile base and you'll understand how handy this is. It makes defence a little harder, but it means you can build multiple bases across a map far easier than the other factions.



## Fire

Taros, representing fire, gets its power from the dark arts, creating legions of undead armies and other such nasties that only come from very bad places. Ruled by a rather miffed Lokken, Taros is a great side to play if you like raw power. They have some great medium range units and a whole bunch of units that have their own magic ability, effectively giving you varied choice in how you want to toast your opponents.



Although units are small, one aspect of the game you can see is the magic effects. How pretty!

was with TA, especially in the higher resolutions or when there's lots of action on screen. With today's setup, 1024x768 should be an acceptable resolution for smooth gameplay, but not so with Kingdoms. The best resolution seems to be 800x600 as this yields moderate smoothness and allows you to appreciate the finer details of the unit animation. At higher resolutions, most of Cavedog's work on the units is hardly visible, and noticeably slower. More to this, Kingdoms is ravenous with RAM, causing a fair amount of swapfile use. What could it want with more than 128M of RAM?

### Suspicious anomalies

This is, as you might expect, not what most fans were expecting. TA managed to push the machines at the time to their limits too, but the game ran fast within these limits. Kingdoms seems to require more grunt than is currently available to the average gamer, possibly putting it out of reach for many of the original TA fanbase.

Also, there appears to be a few stability problems. The D3D mode caused strange effects that were greatly distracting. Switching to software lets the game be played in all its glory, but even then it seemed to bomb out and crash every now and then. To make sure

it wasn't my system playing silly buggers, latest drivers were installed for video, and the video card underclocked to be sure, but alas it made no difference. One hopes Cavedog hasn't released this title just a wee bit too early.

### Less is more

Performance aside, Kingdoms is typical of TA gameplay. Build lots of units, carefully take advantage of their abilities, and strategically attack and defeat your opponent. However, in this regard, be prepared for some big changes.

As you would expect, Kingdoms comes from a completely different angle to TA. It's a fantasy based type game, much like Warcraft, and there are four unique (very unique) sides over TA's two. This is excellent, the four sides differ so greatly (one race doesn't even have construction buildings) that each will require unique battle strategies, easily prolonging replayability.

But if you're hoping for sprawling bases, vast arrays of unit types and the plethora of strategies the original TA system provided, you'll be disappointed. Each race only has two or three types of construction buildings and two types of constructed base defences. No more strategically designed bases, no more joy of seeing how well your base holds up against an assault. It's all about units, baby.





The Veruna force came unstuck when rising damp made their base buildings uninhabitable.

**Consolidation**

Speaking of which, there are also less unit types for each class. Rather than the plethora of units available in TA, Kingdoms has consolidated all the standard types to a limited number of task specific units. This removes any cross over in abilities that may have been present in TA, but means you've got less to play with in your glorious campaigns against the evil that is your networked pal.

Lastly, there's only one resource to harvest from fixed locations - mana. You need to build lodestones to both harvest and store mana, and higher level construction units can

build the more efficient divine lodestones (can't help but think of these as 'moho lodestones').

There are likely many gamers who find this consolidation in Cavedog's game design to be an advantage. It does, after all, focus more of the players time on troop movement and battles rather than resource management and base design. But perhaps in designing Kingdoms like this Cavedog have alienated the RTS gamer who does like sprawling bases, resource management and a plethora of units to choose from. Perhaps it would have been better for Cavedog to combine the two, giving options of 'basic' and 'advanced' play, simply making large portions of building and unit types unavailable for those who prefer simpler RTS style gameplay.



**Smooth single player**

Cavedog should be commended for the one player aspect of the game. Although there's no doubt that Kingdoms, like TA, will be played more for its multi-player gameplay, the single player campaign has been very well designed.

There are a total of 48 missions in the campaign, and every single one of them is preceded by a video introduction and update to the story. This creates excellent atmosphere and gets you eager to enter the conflict. More than this, however, is a rather unique twist. You don't play one side all the way through and then start over with another, instead all four factions have been integrated into the single player campaign, and you get to take control of different sides at different stages in the story. Nifty.

Overall the gameplay is similar to TA, bar the emphasis on bases and resources. The same TA style command set and queuing is present, which even back in TA was a brilliant design concept. Queuing construction orders and controlling of your forces through easily created and accessed groups makes it possible to command huge armies with ease.

As with Total Annihilation, Cavedog will also be supplying regular downloadable unit upgrades to Kingdoms.

**Great stuff, but...**

There's no doubt that Kingdoms is an impressive and fun game, but for this TA fan there seems to be too much missing from the original, and most of the stuff that made it such a classic. Perhaps Kingdoms aims to fill a different niche, trying for those gamers who love RTS games but don't

want to be bogged down with too much choice or base management. If this your style, then you'll find Kingdoms just to your liking (if you have the hardware to play it). If the aspects you loved about TA were the massive unit and building choices, and all the possibilities that lie therein, you'll probably be disappointed by Kingdoms.

*Ashton Mills*

**PLUS+**

Kingdoms is here!

NEWS/PRESS ABOUT SUPPORT STORE ADS

www.cavedog.com

Go here for the latest downloadable units.

**84%**

**For**  
Graphically impressive, typical TA style gameplay, four unique sides and an excellent one player campaign.

**Against**  
Slow even on fast machines, not the same depth as TA, less units, far less building types, stability could have been improved.

**Need**  
P200, 32M, 4X CD, 100M HD space (joke!)

**Want**  
PII 300, 64M+, 3D card

**3D SUPPORT**  
D3D, Glide, software

# The Kingdoms are in chaos...



Attack on full 3D terrain filled with forests, castles and cities.

**T**HE ONCE MAGNIFICENT land of Darien has been brutally divided among four sibling monarchs. Now it is time for you to embark upon a massive crusade to rule the Kingdom of Darien.

Choose your side, plot your strategy and prepare for the fight of your life: the epic battle to conquer the land of Darien.

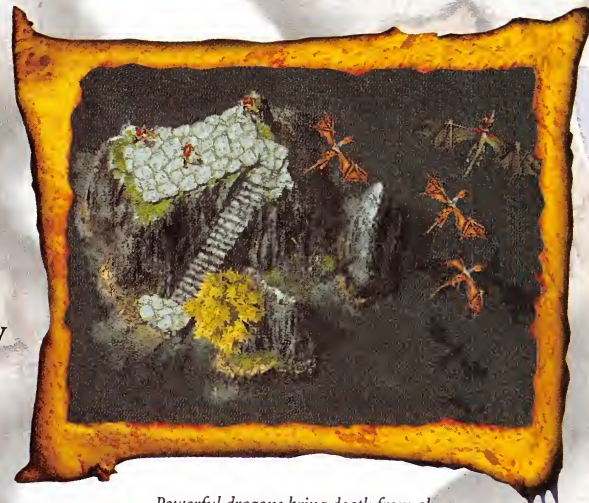

Powerful dragons bring death from above.

## Features

- ☞ Play as one of four unique civilisations with different build hierarchies and combat strategies.
- ☞ Command armies of undead zombies, foot soldiers, dragons and beasts of the earth, sea and sky.
- ☞ Use weapons forged from steel and stone. Attack on foot with swords or at a distance with cannons and catapults.
- ☞ Traverse 3D environments filled with forests, marshes, rolling hills, and mystical keeps.
- ☞ A streamlined and intuitive interface lets you concentrate on the combat.
- ☞ Challenge friends over LAN, modem.
- ☞ Features hardware support for stunning graphics and special effects.



Charge with hundreds of unique units including monsters, dragons, catapults and skeleton archers.

"TA: Kingdoms is a fantasy tag-team match on a global scale. It's melodrama, its excitement, it works"

-Computer Gaming World: Cover story

"Kingdoms is completely unbelievable"

-Imagine Gaming Network

"... some of the most amazing character design we have ever seen ..."

-GameFan



Attack the skulled cliffs of Taros with mighty naval vessels.

the epic battle to conquer Darien begins June 1999.

# TOTAL ANNIHILATION KINGDOMS™

distributed by  
**GT Interactive Software**  
 Australia Pty Ltd

**CAVEDOG**  
 ENTERTAINMENT  
 & GT INTERACTIVE COMPANY  
 www.cavedog.com

  
 Yet to be  
 classified

©1998 Humongous Entertainment, Inc. All Rights Reserved. Total Annihilation and Total Annihilation Kingdoms are trademarks of Humongous Entertainment, Inc. Cavedog Entertainment and the Cavedog Entertainment logo are registered trademarks of Humongous Entertainment, Inc. Created and published by Cavedog Entertainment, a division of Humongous Entertainment, Inc. Distributed by GT Interactive Software Corporation.

# HEAVY GEAR II

Genre: Mech Sim | Players: 1-10 | Developer: Activision | Publisher: Activision | Price: \$TBA | Rating: G | Available: Now

Finally, a mech sim that doesn't play like one. Move over Mechwarrior, the Gears are taking over.

**M**ech sims are great. The whole idea of hulking around in fifty foot walking tanks blowing up everything in sight is attractive to any power crazed male. Problem is, such massive behemoths have a habit of piloting like walking bricks. Fun, sometimes, if you like driving heavily armed bricks around.

## History lesson

The classic Mechwarrior style sim started to change form when Heavy Gear hit the scene. While initially showing great promise, Heavy Gear wasn't quite the hit Activision wanted it to be. Apart from the graphics engine, it was bound to be hard launching a new game that was seen to be ripping off an idea from the popular Mechwarrior series. Still, after Activision lost the Mechwarrior license to Microprose, it was brave of them to try. And now their efforts are paying off.

## Kinda mechy

Gears aren't like the massive war machines found in Mechwarrior. They can be best described as oversized battle suits, and as a result they're a whole lot more manoeuvrable. When it comes down to it, manoeuvrability is just as important as the size of the gun you're toting, and so the Heavy Gear game design manages to balance movement with weapon



A picturesque countryside setting in Heavy Gear 2. Get back to nature - and blow it up.



power very well. In fact, this has been refined in Heavy Gear II and when combined with the new graphics engine, HGII manages to strike an excellent balance between mech sim and fast paced FPS. It can be best described as a blend of Shogo and Mechwarrior, and it's a highly addictive mix.



## Like a Rolls Royce

Heavy Gear II is powered by the all new Dark Side engine, and it's mucho impressive. Setting the resolution to 1024x768 and turning on all the visual things as any gamer would, one might think the gameplay to be a little slow. Not so. On a PII 450 TNT system the gameplay was smoother than silk, completely slick and seamless. It also looks spectacular, supporting resolutions up to 1600x1200 and 32bit color. Right from the first mission you're drawn in by the attention to detail in the environment, everything from the foreboding sky to the ripples made by rain hitting the swamp. Even the sounds have been attuned to the atmosphere - from the background hum of night critters to the sound of your gear sloshing through the swamp to the radio chatter of squad members - it's



the most enveloping environment yet experienced in a mech sim.

The speech deserves particular mention. Squad mates voice their thoughts, shout cries of victory, and hurl rather cool insults. You get to hear communications from your dropship and sometimes intercepted enemy radio chatter. None of it is cheesy or out place however - it all fits very well in with the atmosphere and goes far in adding that extra dimension of absorbing gameplay.



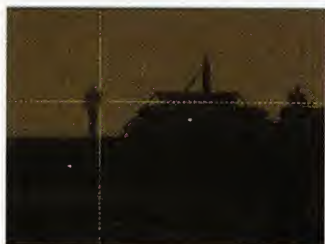
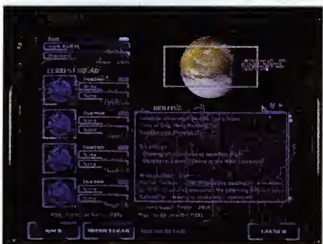

(top) Ashton finds shelter under the tree canopy to prevent rust from upsetting the sparkling sheen of his freshly restored antique Gear.

**New style of play**

It's not until you enter a fire-fight that you get to see HGII shine. The intelligence of your squad mates and the enemy is excellent - the enemy reacts to your movements and will sometimes attempt to outflank you, and at other times just charge straight in hoping to blow you away. Squad mates react smartly to the battle as it happens, but you also have complete control over their movements, targets, battle style, and formation through an on-screen command menu. Using the tactical map it's possible to direct your squad mates and watch events unfold from afar. Some missions even call for this.

The missions are another refreshing aspect of HGII. The one player campaign involves your usual seek and destroy and all out war type of scenarios but also includes other mission types such as ambushing and trailing, where the object is to shadow a target to a destination. Each mission has a set threat limit ('threat' is the offensive power of a gear) and you get to fully tailor your gear within this limit. When it comes to tailoring you have an extensive weapon and equipment list to choose from, broken

down into four classes of energy, missile, projectile and indirect. Some of these weapons are just so much fun to play with, especially some of the heavier indirect weapons (gotta love mortars!). There are loads of gear types to choose from, ranging from light to assault gears, and within each type there is a set of modified versions, often tailored to a particular task like sniping, heavy weapons, amphibious movement and so on. It's a huge choice and definitely adds depth to the game.

**Zero G**

The missions take place in a variety of beautifully detailed zones. You get to admire and fight in vast grass plains with rivers, dark swamps, jungle, urban environments, frozen wastelands and even the vacuum of space. Zero-g piloting is an entirely different form of play, and needs to be mastered to get anywhere in the single player campaign.

Controlling gears can take some getting used to. The torso moves independently of the legs, so it's possible to move in one direction and shoot in another. A joystick is



a must for this, and once you get the hang of it, it's amazing to fight in fast paced battles. And that's essentially the key element of Heavy Gear II, it plays like a FPS but in the

game universe of heavy handed war machines. It's addictive, plain and simple.

The intro movie is brilliant too, and reminds me of the day that we at PCPP first laid eyes on the Mechwarrior 2 intro and





deemed it 'The most awesome drool inducing intro of all time'. This famed and sacred blessing later moved to the Independence War intro, but it's fair to say the HG II intro comes very close indeed (actually, so does the Mechwarrior 3 intro). The joy of it is that you get to witness more of this same style of movie making throughout the singleplayer campaign. It's good stuff.

**An orgy of gears**

The game is, of course, multiplayer-ready and apart from the

usual deathmatch scenarios there is also capture the flag and team scenarios with group objectives. This is a nice touch, but if you don't prefer rubbing shoulders with pals you won't be disappointed by the single player campaign. A set of historical missions set in the HG universe are also included, as well as a set of stan-



dard training missions, all of which should keep you happily occupied.

**Fast-food gaming**

The obvious comparison to Mechwarrior 3 will eventually be made, so I might as well bring it up now. By all accounts

Mechwarrior 3 is a far more involving game. It's deeper at the mech tailoring level, deeper in the graphics engine (though I don't think it's as pretty as HGII), and deeper in terms of game design, closely following the Mechwarrior universe. Heavy Gear II isn't like this, aiming more at fast paced action combined with a little strategic management. Heavy Gear II gives you all the armoured battle fun of Mechwarrior, but in a fast food kind of way. It's a great mix of FPS style action and the enjoyment of heavy hulking war machines. Having played both HGII and Mechwarrior 3 I think it's fair to say that each fits a specific playing style and each is equally enjoyable. If attention to detail is what you want, you'll probably find Mechwarrior 3 more your style. But if you want an easy to get into, gorgeous looking, fast paced action game, Heavy Gear II will fit you like a well armoured glove.

Ashton Mills



(left) It's always at moments like this that you realise you forgot to pack those crucial brown trousers.

**PLUS+**

[www4.activision.com/games/heavygearii/](http://www4.activision.com/games/heavygearii/)

**GOLD**

**93%**

- **For**  
Fast paced action in the Heavy Gear universe. Excellent blend of FPS gaming with the joy heavy war machines provide. Fantastic graphics engine, absorbing atmosphere.
- **Against**  
Zero-g piloting can take a while to master, as can the separate torso/leg movement. Erm, that's it really.
- **Need**  
P200, 64MB RAM, 4X CD, 450M HD space, 3D card required
- **Want**  
PII 300, 64MB RAM, 3rd generation 3D card

**3D SUPPORT**  
Direct3D



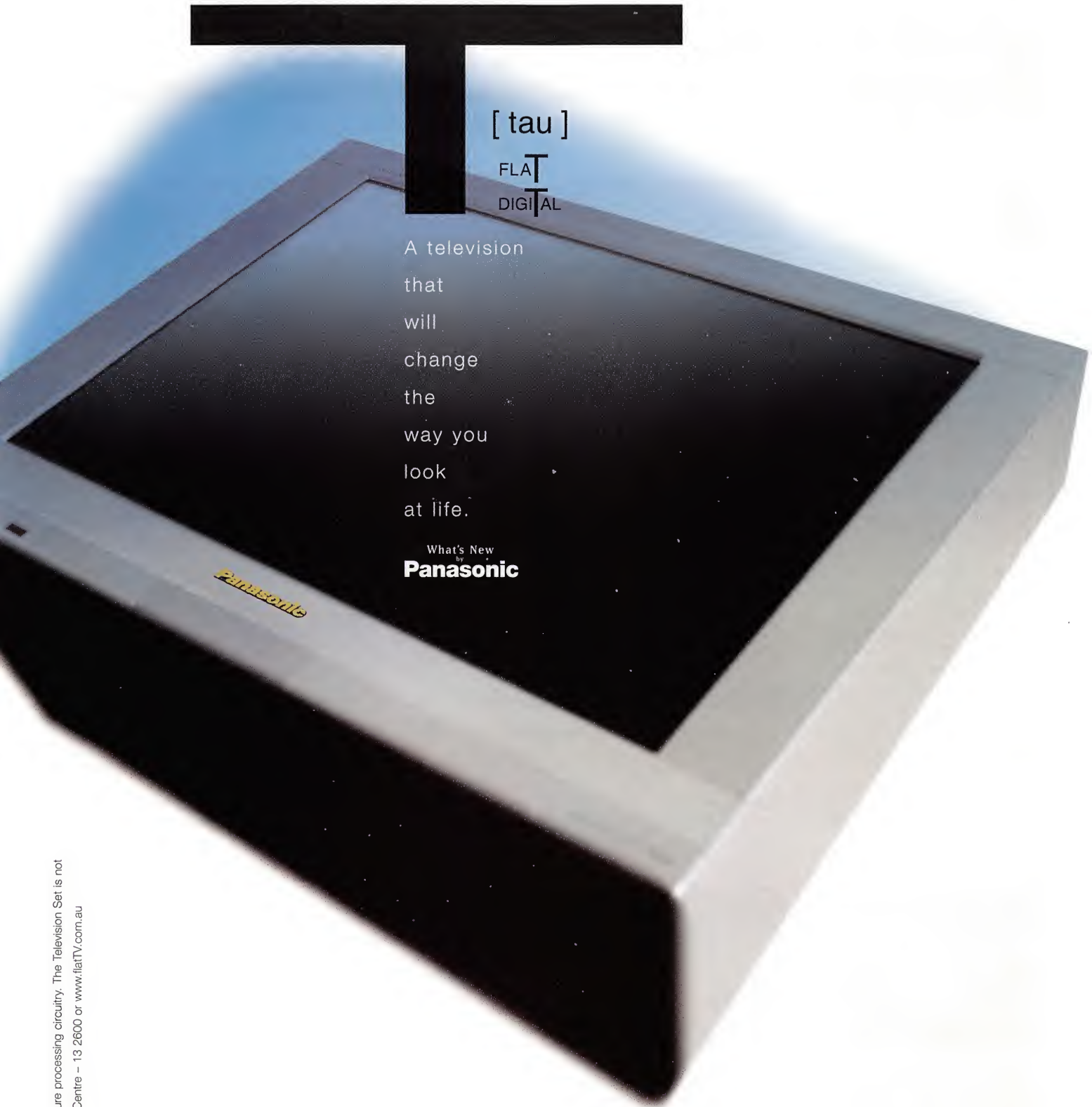

[ tau ]

FLA<sup>τ</sup>

DIGI<sup>τ</sup>AL

A television  
that  
will  
change  
the  
way you  
look  
at life.

What's New  
by  
**Panasonic**

The usage of "Digital" in the tau logo indicates digital picture processing circuitry. The Television Set is not designed to receive digital transmission. Customer Care Centre - 13 2600 or [www.flatTV.com.au](http://www.flatTV.com.au)

TEAM MILLENNIUM OLYMPIC PARTNER™



**Panasonic**

# MIDTOWN MADNESS

Genre: Ballistic arcade racing | Players: 1-8 LAN(IPX, TCP/IP), modem, serial, Internet | Developer: Angel Studios | Publisher: Microsoft | Price: \$TBA | Rating: G8+ | Available: Now

Finally we have a racer with gameplay straight out of *The Dukes of Hazzard*. Hot Damn!

**T**he Dukes of Hazzard. They drove around country roads really fast, made the cops crash and always, always got serious airtime in the General Lee - their orange stunt car with the confederate flag on the roof. Which had its doors welded shut to strengthen the body structure. The Dukes would arrive in a sweeping handbrake turn, immediately spring out of the windows and land on their feet, cool as ice cream. Stuff to live by.

## Doughnuts!

This is that game. *Midtown Madness* has very little discernible "point", much like the *Dukes of Hazzard*. Similarly again, you're just having fun, it's really fast and stuff just looks cool. There are a couple of minor differences, like it's in a city, not Hazzard County, and in heavy traffic, not on quiet dusty roads. The Cops hassle and chase you, but aren't really capable of doing anything like shooting you or getting out and making an arrest. It's rather sporting of them, really. They probably just shout "Those Djukes!" into their CB radios and finish their doughnuts.



(above) The dents clearly indicate that ED has taken it up the rear too many times.

## Maxim, um.. air

*Midtown Madness* has probably the most comprehensive city ever placed into a 3D driving

game. It's huge. It has hundreds of buildings, backstreets, and alleyways, and a massive freeway skirting one side of town. It's got a river running through the centre, with bridges that split the road to allow boats through. These are actually cleverly disguised mega-jumps whereby you can live up to the Duke boys' maxim of getting huge air whenever you can. And how you will. You will get more air than a low-earth-orbit Bill Gates satellite. The air in this game is intense.

## Boss Hogs

Mostly you just drive around and escape the cops, but there are a few modes where you can race through a set course, or one where you just have to pass through a series of checkpoints in any order. These are okay, but it's too organised to be of any great lasting interest. The fact that you are always racing around the same city makes the race concept kind of flat.

The best way to play this game, without a doubt, is multiplayer in the Cops and Robbers

mode. This is *Dukes of Hazzard* CTF. The Robbers team has to seek out a thing of Gold, and take it to the hideout. This gets you points. The Cops, naturally, have to get the Gold thing as well, and take it to the Bank. You make someone drop the Gold by smashing into their car really hard. They can also drop it by totalling their car (the cars take realistic damage, deform after crashes and leave parts behind). This mode is utterly awesome. It's like, the reason the game was made. Single player unfortunately doesn't have a Cops and Robbers versus the AI, but just driving around and doing cool stuff in freeform mode (which usually attracts the AI Cops' attention, resulting in a chase) is quite good anyhow.

## First class physics

Why is it so much fun? It's mostly the fact that it has a near-flawless look and feel. The cars all roll on their suspension, behave quite realistically and obey an absolutely first-class physics engine, which includes





(left) Okay, everyone just act real casual and maybe the insane Volkswagen driver won't see us...

impressive smash effects and dramatic collisions. People looking at the game are inclined to say "cool" and want to have a go. It's like the Arcade games that came out just before Arcade games became the mostly shameless rubbish they are today. Before all the decent programmers and designers went off to do PC and console games. Like Motocross Madness, you're in this game for seconds, and you're having fun.

You're there

I started it up for the first time, and began with my car at the front row in an intersection, waiting for the lights to turn green. Traffic was flowing past in both directions. To the hori-

zon I could see a continuous cityscape of buildings, power poles and pedestrians trailing away like it had always been there, casual as you please. A wispy cloud flowed across a bright blue sky and I noted the gleaming metal effects on the vehicles, which seemed to reflect colours from the surroundings.

As I observed for a moment, I heard a sudden screeching noise, and a brown van skidded in from stage right and stacked into my car, shoving it against the other cars at the lights, which also moved marginally. The van thudded back onto its rear wheels and rolled slowly backwards. I heard a voice muffled through glass, shouting "Maniac!" in an irritable tone,

from the driver of the van. Coolness had arrived. The traffic is totally random, with random accidents, ala real traffic. This is the first time this has been done with any great skill in a 3D driving game, on this scale at least. You can be hammering up the freeway at top speed with ten cars in front, and twenty travelling in the opposite direction, all visible with

absolutely no slowdown. It's a regular peak hour sim. It's really fun weaving through the high-speed traffic on the freeway, finding slim gaps between cars. Then when you make a mistake, oh! Big catastrophe! All the cars behind you will pile into the smash as well.

There aren't any motorcyclists, though. And the range of differing vehicles is not as massive as it could be. It's about ten different

cars, with different colours. You can gradually unlock the school bus and chunkier sports cars to use for yourself by winning particular races or getting a certain score, though.

The art of destruction

Midtown Madness is full of smashable stuff, like bins, power poles, traffic lights, glass windows, post boxes and cargo crates. All the cars are impressively destructible, losing parts and respectively losing functions as portions of the vehicle are destroyed. Wheels get bent and wobble, then come flying off. Windows smash. Bumpers lose one mounting and drag on the road, creating showers of sparks. Panels deform in 3D, and lose their nice deco finish. It's all there.





# MAX

**The Original Magazine  
for Australian Men**

**“You’re Only Male Once!”**

**On sale monthly**





# CLASSIC GAMES

C O L L E C T I O N

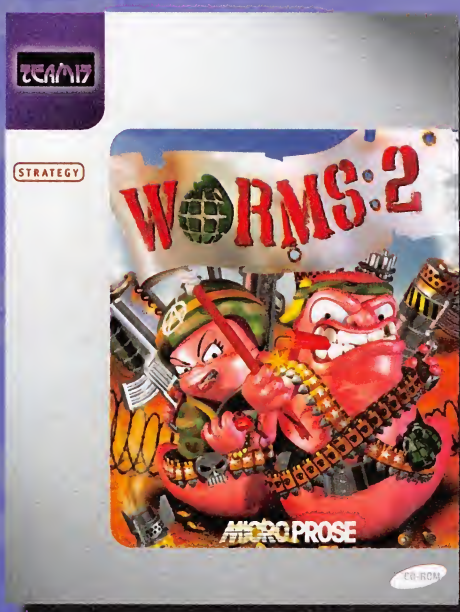
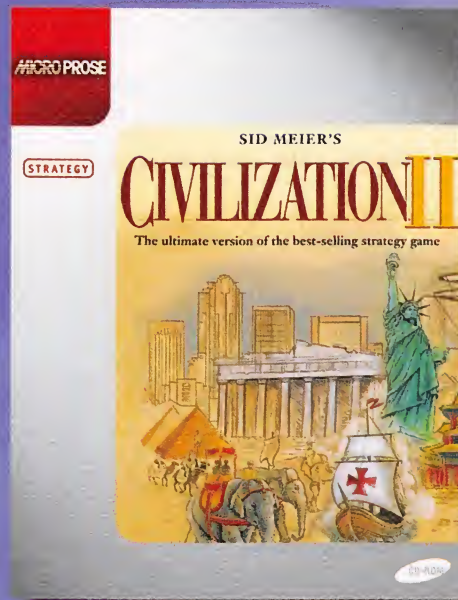

# GAMES FOR EVERYONE!

from

\$1995

The titles,  
the price,  
and the fun!

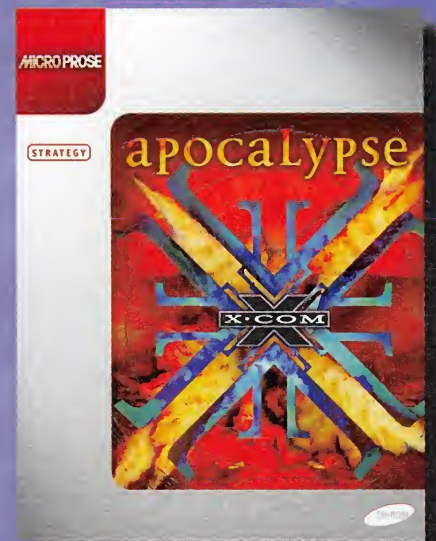
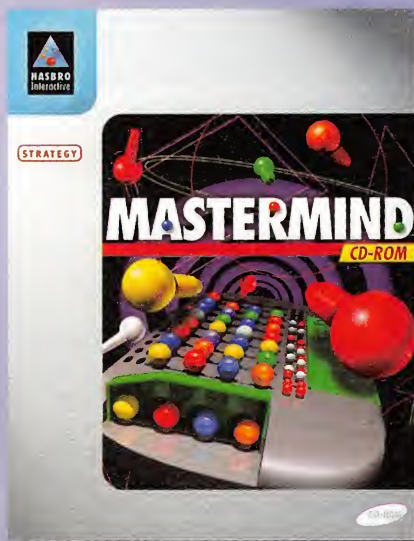
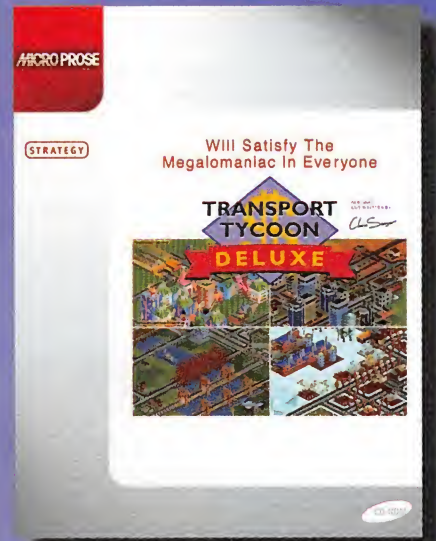

## SPORTS CAR GT

Genre: Racing | Players: 1-6 (recommended), IPX, TCP/IP | Developer: Image Space | Publisher: Electronic Arts | Price: \$49.95 | Rating: G8+ | Available: Now

Fitting nicely in between TOCA 2 and Grand Prix Legends, Sports Car GT is a sedan sim racer's specialty.

**P**eter Dumbreck's five end-over-ends at Le Mans in his Mercedes CLR on the run up to Indianapolis corner at 300kph recently, was one the most spectacular motor sport accidents you will ever see. Well now the opportunity is there for us to do the same (well almost anyway). Image Space Incorporated are the developers of ASP Animator Pro simulation visualization tool for General Motors. So if GM think their physics engine is good enough to test their real cars it all looks good for us when ISI decided to make Sports Car GT a reality for us to flog \$1,000,000 dollar cars around Laguna Seca, or any of the numerous tracks available inside the game.

## It's a long road ahead

For the unfamiliar to GT racing, a light comparison is the GTP Production series that runs in conjunction with the Super V8's right here in Australia. Gameplay consists

of advancement through the ranks of championship racing in four different classes: GT-Q, GT-3 series, and GT-2 series, then ultimately, the GT-1 series where you get your hands on some of the most beautiful cars available on this planet.

But before you get there you must progress via winning money and upgrading your existing cars. Buying and selling cars, upgrading parts and the like. As you progress so does the Artificial Intelligence. The choice is yours for how long you would like to race, from one lap or 9999 laps to a full-blown 72-hour races. Also included are options to increase tyre wear by 8x or fuel consumption to the



(left) Question: Do you find it reassuring to know that the car you're driving is seemingly made of ectoplasm?

same multiplication. So, in shorter races pitting can be incorporated to suit the race length and what you have chosen for your fuel and tyres. A major flaw though, is the fact that you can't save your game during races, so if you decide to have a big one, the only way around losing your current game is to hit pause and don't turn off your PC, until you finish the race (not that I would do that...). Hopefully in future patch releases this will be rectified.

## Patchwork Quilting

Patching is a must, if you really want to get the best out of what ISI has offered in its raw



(left) 8th place? Oh dear, the old driving game screenshot curse to make the PCPP staff look crap strikes again.



form. After downloading the 1.5 upgrade, 3rd party cockpits, sounds, and physics patches off the net, the game was truly transformed into a mixture of Toca2 and Grand Prix Legends physics, or if you prefer, an arcade racer. I could have based this review on the straight out of the box purchase, but this would only resulted in a point of view that would not be true of SCGT. As with just about all games, what you get from the box is normally inspected by the world of gamers and then those that have the skill, start adding things they found lacking in initial releases and improve on them. Sports Car GT straight out the box is, quite frankly, awful. Sound is the biggest problem, with your car sounding like a food blender gone bad.

**The Brain Factor**

The Artificial Intelligence of the game's cars is very good, as with most of the newer sim racing games at the moment, with no problems that I could really

mention. Their difficulty can be adjusted simply by a slider in the menu options. Sometimes racing simulation AI cars just continue to go around smoothly, never smashing well. In SCGT, expect to come around a corner and see dust and smoke up ahead because AI smashes are a common occurrences when the first few laps are under way, just like in real racing. Then they tend to dissipate as the race goes on.

**Fast cars fast computer**

I played SCGT on a Celeron 450 with 192 meg of RAM and a Diamond Monster Voodoo2 12 meg card, and at 800 x 600 frame rates are unacceptable without reducing the graphics options to their lowest settings. I used a Logitech Wingman formula force wheel to test the



force feedback characteristics of the game, with no problems found at all. Internet play is fine as well, while not up to the standard of Grand Prix Legends, it is far better than the Toca2 code over LAN.

*Phill Bennett*

**PLUS<sup>+</sup>**

Electronic Arts  
[www.sportscart.com/](http://www.sportscart.com/)

**GOLD**

**90%**

- **For**  
 Graphics are superb if you have the right machine to run the game on. Pit stopping is incorporated very well to the game. Physics are very good once patched.
- **Against**  
 Patching has to be done to this game if you really want to play it to its full potential. Annoying unlock codes needed once again. The need to have a super fast computer to get the most out of the game.
- **Need**  
 Pentium 166, 32MB RAM
- **Want**  
 Pentium II 266, 32Mb RAM

**3D SUPPORT**  
 D3D and 3dfx

# MIKE STEWART'S PRO BODYBOARDING

Genre: Bodyboarding sport game | Players: 1 | Developer: Gee Whiz! Entertainment | Publisher: PlayCorp | Price: \$TBA | Rating: G | Available: Now

Americans on Esky lids. Is there a better idea for a sport simulation?

**B**odyboarding has always been given a bit of a “hobbyist” tag when compared to its older brother, surfing. Surfers even refer to them here derisively as “Esky Lid Riders”. And if you’ve tried bodyboarding, you have to admit, it does seem pretty easy. Surfing is definitely a sport unto itself, but bodyboarding seems to be the saccharine, Lo-Cal, “girls milk” flavour of the wave catching sports. It’s much easier to get into, the gear is much cheaper, and totally kiddie-safe. The fibreglass and solid bladed fins on a surfboard provide ample cut-and-bludgeon potential when you are wiping out, whereas it’s well-nigh impossible to brain yourself on a squishy piece of foam and plastic. By comparison, it’s almost like wearing training wheels. You don’t look as cool as the surfers, you have to wear flippers, the tricks are less impressive, you can’t hang ten anymore, the list goes on. Possibly the biggest indicator is the rare sight of someone over 25 carrying a bodyboard. The serious ones graduate to surfing for their twilight years.

### Marshmallow technicians

Now our cute Californian friends have taken it upon themselves to show us a bit of what



professional bodyboarding is like. Hoo-aah. This’ll be wild.

Presumably it’s an incredible adventure of a lifetime that will rock our world. Or so they would have us believe. Being a professional bodyboarder, it must be like working at Legoland or being a marshmallow technician or something. Where you can claim you are the best in your field, but nobody could really give a chiko roll dropped in sand

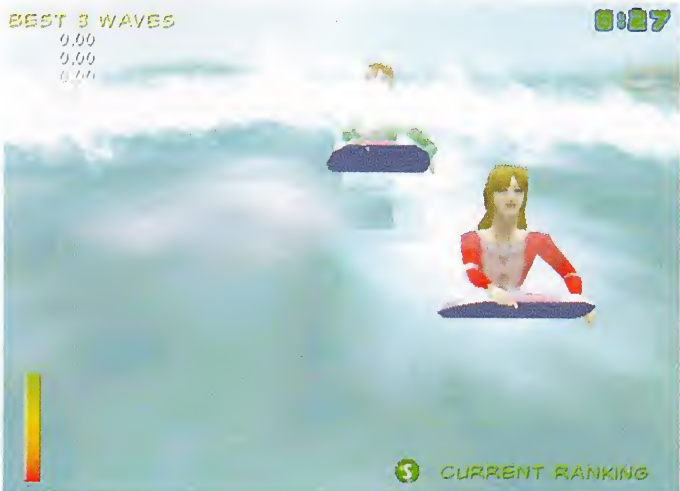

Meet Mike Stewart - allegedly the world's first transgendered gaming star.

to find out whether you are or not. They simply don’t care.

### A bit flat

The game takes a fairly standard layout, where you simply choose a rider, choose their board and choose which beach to surf on. You then paddle about on a dead flat ocean, in full 3D camera mode until an odd-looking lumpy wave rises magically from the water behind you. Then you must paddle with it, in the direction that it will break across the beach. If you’re in the right place, the view zooms out from what was a very 3 dimensional view to a fixed angled view above the wave as it travels. This really flattens the 3D effects, and dissipates any

positive effect the effort of making the whole thing 3D might have had. Your bodyboarder travels more or less at a constant speed in front of the wave, and you dally about doing little spins and flips, getting air off the lip and 360’s and all the rest of it. You can speed up by hugging the leading edge of the wave and coasting carefully and high. You can survive inside the wash zone, if you have enough residual speed to escape.

### No drop-ins

Mike Stewart Bodyboarding is a fair attempt at replicating some aspects of the activity of bodyboarding, mostly within a competition framework. In the competition you spend a fair bit of





(right) We've been assured that these girls are not naked. They're just wearing really tiny g-string bikinis, obviously.

time paddling about, trying to be in the better position to catch a wave than the competitors because you get penalised for "dropping in". That is, if someone has caught a wave and is beginning to ride it, you are not allowed to join the same wave. Obviously there's not enough room for two. So staying out the back is a good strategy because you can claim a wave early and others can't try to take it off you. The claim is made by the person who first begins to move at the same speed as the wave itself, ala, they're surfing.

**Just ridiculous**

It's strange. With every passing issue we always think we've seen the most inane, bizarre and downright stupid simulation game, but somehow they keep on outdoing themselves. The idea is, basically, that you will want to play simulation games because you have no way of experiencing the sport or whatever in reality. Then they go and simulate table tennis, which is just absurd.

Likewise, I would call, is a

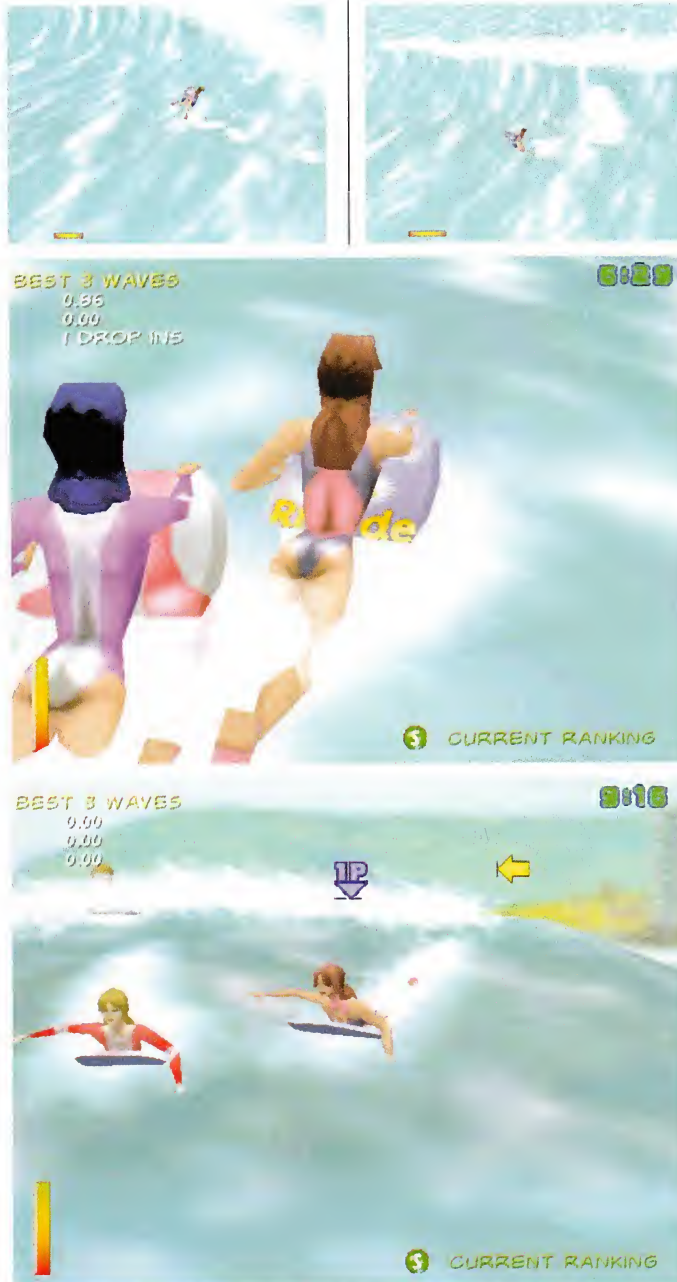

bodyboarding simulation. Bodyboarding is all about being outdoors, swimming and getting rigorous exercise while experiencing a particular physical sensation: riding the waves. All of these things are always completely lost on translation to computer game, while the enjoyment you get from the game is predictably extremely limited. I haven't heard of a scuba diving simulation yet, but it would be in exactly the same boat as bodyboarding; it would never compare to the real thing, or provide any part of the things that the



actual processes bring to people.

Let's see who can build a 3D graphics action game based around cooking toast as quickly and efficiently as you can in a cluttered, dimly-lit kitchenette. With a yellow sticker on the packaging: "Guaranteed to improve YOUR toast production skills, or your money back!"

Even the wave graphics are decidedly average, not even denting the efforts of some paltry Nintendo games we could mention.

**Go for the real thing**

I really regret recommending reality as an alternative to computer games, but in this case I have to firmly insist that it's essential. Go get a \$50 bodyboard, then go down the beach. Worth the admission cost alone.

Ed Dawson



**PLUS<sup>+</sup>**

Mike Stewart's Pro Bodyboarding

"Mike Stewart's Pro Bodyboarding uses 3D acceleration to create the most realistic waves yet seen on PC."

**NEWS!**  
It's official and it's cool!  
Mike Stewart's Pro Bodyboarding is now Generation's 30th Game of the Week!

Check it out here  
http://www.mad-generation.com  
http://www.mad-generation.com/Review

[www.probodyboarding.com](http://www.probodyboarding.com)

**34%**

**For**  
It looks a little bit like bodyboarding does. Holds the dubious title of "best bodyboarding game we've seen so far."

**Against**  
Showcases the reasons fairly mundane things aren't often simulated. It's because the likelihood of you getting out and doing them is huge. And actually doing them, in reality, is a million times more rewarding.

**Need**  
P200, 32MB RAM, 50 MB hard drive space

**Want**  
P2-300, 64MB RAM, 100 MB hard drive space.

**3D SUPPORT**  
Most Direct3D compatible accelerators supported

# OUTCAST

Genre: Action/Adventure | Players: 1 | Developer: Appeal | Publisher: Infogrames | Price: \$TBA | Rating: G | Available: Now

Tete, pied, jollie.

**O**utcast is a difficult game to pigeonhole. In a typically European fashion, Infogrames has given us a chameleon in this boundary-tickling adventure. Is this pure action or quest based adventure? So many conflicting emotions battle to be heard when considering Outcast: why combine sci-fi, narrative and action elements like a three car pile-up? Why does my character, Cutter Slade move like he's just had some colon surgery? Why does this game LOOK so ordinary, when the promo shots are to die for? But then I think, hey, that music is bloody good and gee those people are speaking nice and clearly. Forget what you heard from E3, ladies and gents - Outcast is not the next big thing. It's the next economy-sized, strange thing.

## Inter-dimensional vacationing

The premise is reasonable enough. You are a US Navy SEAL Commander who must travel into another dimension to stop a gaping black hole from consuming the Earth. You do this by protecting the scientific team that travels with you to the strange world of Adelpha. Apparently you've been separated from them. Fairly standard sci-fi plot, I'm just about ready to pick up my guns and race into battle against some goofy looking aliens. But wait, first of all you have to talk to the native folks who saved you. Apparently you are the Ulukai, the saviour of Adelpha for all intents and purpose. You've come from the heavens to liberate them from Fae Rhan, some dictating so-and-



so and his forces. There's lots to do - save the Earth and Adelpha. Just don't forget your pig Latin dictionary to pronounce the names of all the places in Adelpha.

**It's a question that has had us perplexed for ages. How do they swim so freely when fully dressed and carrying a complete arsenal of weapons?**

## Magical do-hickies

This is a game that tries to be many things. You have a third person perspective of your character like in Heretic II. Your mouse moves the camera, while the keypad controls the movement of Cutter, which is a pretty good system in itself. The game itself requires a lot of conversation with people to get the low-down on what magical do-hickies to look for and what places to avoid. So in this sense, it's fairly adventurish. Does it really mat-



ter?, I hear you ask. Well frankly, neither aspect of the game is incredibly convincing, so you have to wonder what they were thinking. No wait, the adventure storyline comes out ahead since the action is, shall we say, less than exceptional.

## Clunky character movement

Our man Cutter runs, swims, jumps, crawls, shoots and falls on his rear (endless fun...) in Outcast. There are some big concerns with the controls and basically the action of the game. Movement is just not quick enough to establish that action feel. There is no happy medium between game speed and detail (see below for more about detail). Apart from this, character movement is very clunky. Want to get caught amongst some rocks or in a roof? This is your game. Doubtless, the smaller issues will be addressed at the latest with a patch but the absolute basics I still find rather flawed. This is 1999 people, we've seen Half Life - we want better! Not only does the game lack smoothness in motion (that even Tomb Raider had), you'll often find the camera betraying you. If you're crawling amongst some rocks to avoid detection, you may find it hard to see yourself.

## Questionable performance

Screenshots from Infogrames excited a lot of people because





(above) There's a joke to be made about Cutter's alleged colon surgery and the ring here... but we're not touching it.

they looked so flash. When you actually play the game however, the visuals kinda suck. Remember that this is a 3D adventure without 3D acceleration. As a result I can't say that it comes up to scratch. On this humble reviewer's system - a PII 300, 128MB RAM, 4MB video card (fairly standard setup), Outcast looked blocky, blocky, blocky. On the lowest resolution, it ran quickly and looked like Lode Runner. Crank up the resolution and it starts to look rather nice but enjoys considerable slowdown. A footnote to all of this was the testing of Outcast on a grunty PIII 450, TNT2 16MB card (for 2D performance, of course) & 256MB RAM (that's right!). To be brutally honest, the game looked fractionally better and still played like a dog.

**Sour eye candy**

Every now and again you get a glimpse of greatness: water textures, distant mountains, lens flaring. The elements are there for some truly amazing visuals but it's all a bit too pixelated without acceleration. The action of the game suffers due to the visuals being so unconvincing. In the final analysis however, the eye candy is decidedly sour.

**Delicious design**

So what do we have left? Hmmmm, the story. The fusing of a science fiction situation and an Indiana Jones adventure feel is not

a complete failure. Once you get used to the fact that you need to read and pay attention to a lot of talk the game ambles along amiably. In fact it's the story elements that stop this game from being an abject failure. Other great features include the cut scenes (considering the rest of the game) and the music which is performed by the

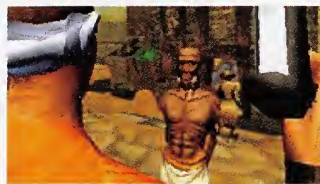

Moscow Symphony Orchestra: very successful. While the art design of Outcast is delicious and conceptually it looks a treat, maybe those French programmers forgot that you need a worthwhile game that is playable AS WELL.

**European action**

Outcast is another game from Europe that started out fantastic but was stillborn. It might appeal to the adventurers out there but I reckon there's better on offer



and no-one should pay valuable dollars for a half-arsed game like this. I must admit to being a little unsettled by Outcast-it REAL-LY annoyed me. Make sure you check out any other games that use the Outcast engine. Some good may come of this yet.

John Dewhurst

**PLUS+**

The University of Chicago Press, Journals Division

THE ASTROPHYSICAL JOURNAL and SUPPLEMENT SERIES

Learn all about parallel universes, black holes and quantum theory form The Astrophysical Journal

[www.journals.uchicago.edu/Apj](http://www.journals.uchicago.edu/Apj)

**59%**

■ **For**  
Nice music, nice cutscenes, nice story but frankly overshadowed by...

■ **Against**  
Particularly unsatisfying gameplay, frustrating control, Outcast was not made to run on most gamers' PCs.

■ **Need**  
P200 MMX, 32MB RAM (hal), 4x CD ROM, Win 95

■ **Want**  
PIII 600 MMX, 128MB RAM, 8x CD ROM, Win 95/98

**3D SUPPORT**  
Software only

# SAGA: RAGE OF THE VIKINGS

Genre: Real time Strategy | Players: 1-6 | Developer: Cryo | Publisher: Cryo Interactive Entertainment | Price: \$TBA | Rating: TBA | Available: Now

They drank their own urine on long sea voyages and discovered America long before Mr Columbus. But that's not important right now...

In an industry where the consumers are, on the whole, more informed and more discerning than they were several years ago, developers wishing to turn a profit must strive to provide unique and innovative gameplay experiences. Gone are the days when retail success could be virtually guaranteed by the emulation of a successful title. Developers stubbornly adhering to old doctrines and procedures are experiencing backlashes from both the press and consumers, and dwindling profit margins. Unfortunately *Saga: Rage of the Vikings* is a textbook example of a title developed with this obsolete mentality.

## Age of Trolls

Initially, *Saga* seems like a moderately promising title. While its *Age of Empires* roots are immediately evident, the game's historical and mythological foundations are interesting. The player is able to manage a tribe of Vikings, Elves, Dwarfs, Trolls, South People (Christians opposed to the pagan religious beliefs of the other tribes), Centaurs or Giants. On offer are a range of training missions, approximately twenty indepen-



dent scenarios, multiplayer support and a scenario editor.

The undertaking of the training scenarios is where the trouble begins. While these scenarios competently verse the player in the management of their

minions, they also reveal the shallowness of *Saga's* gameplay. Players who complete the training scenarios will be dismayed to discover that, in the course of learning *Saga's* mechanics, they have experienced all that the game has to offer. There are no exciting new units to create, no additional resources to exploit, and no splendid new buildings to construct.

## Village pillage

This offers the player almost no incentive to attempt completion of the independent (read unrelated) scenarios. This staleness also extends to the game's lacklustre visuals and uninspiring animated cut scenes. Successful completion of a scenario rewards the player with a single generic victory scene which is repeated with each and



Whether on four legs or two, the medieval female was always reliably well-endowed.

every victory thereafter. While this scene is admittedly awe inspiring the first few times, it tends to wear thin very quickly.

Most disturbing of all is the paltry number of unit types available to each faction. Excluding cows, only two or three units can be created by the player. These are basic male and female characters that are capable of constructing buildings, collecting resources and producing offspring. The male characters double as offensive and defensive warriors. Most factions are also able to create a type of enhanced warrior unit. These units are better at fighting than standard males, and one of these units per faction can become a magician if it is trained in the art of magic.





**Stealth veterans**

Weapons and armour can be upgraded to produce more powerful warriors, but there is no visual distinction between warriors equipped with (for example) cloth armour and standard arrows, and those outfitted with much stronger armour and magical arrows. Close examination of individual unit statistics reveals such pertinent information, but pausing to check stats simply isn't feasible when the player's village is being plundered by an enemy tribe.



The magic system adds some depth to the otherwise dull gameplay. Unfortunately this is countered by the fact that, in the heat of battle, the player very rarely has time to select a magician, choose a spell, then pick a target. As a result, the player is often limited to using

spells during peacetime. For those with a predilection for hunting defenceless creatures, this can serve to temporarily alleviate boredom; fireballs and lightning bolts are gratifyingly effective when used to accumulate baby Harp Seal pelts and venison.



The advantage of using your fireball-throwing magician to hunt for food is that the unfortunate deer get cooked at the same time.

**Bovine mitosis**

There are also curious inconsistencies in the management of resources. While nine units of food will keep seventy people amply fed for days, five units of hay are required to breed a single cow. However, this anomaly may be explained by the fact that cows seem to undergo a peculiar form of bovine mitosis. A male and female of a humanoid species are required to produce offspring, but calves are generated from a single cow.



Dabbling in genetics is another feature that may momentarily distract bored players. Interbreeding various species in order to enhance and expand the existing gene pool is something the game's designers encourage. Unfortunately the union of Trolls and Centaurs, or Elves and Giants never results in freakish hybrids. Instead, the enterprising geneticist is rewarded with a pure strain of either parent species. Like every other aspect of the game, this soon wears thin with distressing rapidity.

**Age of Vikings**

Summed up in a single sentence, the game can be adequately described as an inferior Age of Empires clone, minus the 'age' part. Lacking wholly in originality and longevity, Saga: Rage of the Vikings is only recommended to those who absolutely cannot wait for the release of Age of Empires' sequel. Saga's lack of distinguishing features will inevitably see it relegated to the bargain bin. With so much potential locked within the culture of one of history's most famous civilisations, it is truly a shame to see such potential wasted.

Brett Robinson

**PLUS+**

<http://www.iglobal.net/psman/barbarian/index.html>  
The Ultimate Barbarian page. An excellent resource for those interested in Vikings and Norse Mythology.

**42%**

- **For**  
The Online Manual contains interesting information on Norse Mythology.
- **Against**  
Dated visuals and extremely limited gameplay.
- **Need**  
P166, 32MB RAM
- **Want**  
P200, 32MB RAM

**3D SUPPORT**  
None

# F22 LIGHTNING 3

Genre: Flight sim | Players: 1-16 by LAN, 1-128 in Novaworld all by Internet (TCP/IP) | Developer: Nova Logic | Publisher: EA | Price: \$69.95 | Rating: G | Available: Now

In the course of reviewing this splendid flight sim we learn more about the Major's shady past...

**A** long, long time ago (something in the order of 18 years), on a field firing range deep in the heart of Puckapunyal, a young Officer Cadet Lindgren asked himself "just how do I conquer the next hill full of enemy with my platoon of men?" "Tac Nuke of course!". It was certainly the flavour of the day and an often-used cynical joke. It was a time when small thermonuclear devices could be launched out of artillery tubes, and it heralded much heated discussion.

### Big bangs

Well, we now have that capability in F22 Lightning 3, and while I acknowledge that "Back to Baghdad" gave us the first air launched nuclear weapon; you just wait until you feel the blinding flash and shock wave that follows the detonation of a 10 Kiloton B-61 Tactical Thermonuclear Bomb. It rocks!



**The 10 Kiloton B-61 Tactical Thermonuclear Bomb! Looks nice, but you really would not want to be this close!**

missions in the Quick Missions Menu selection.

### Canned missions

Briefings are good with plenty of detail and, while the map areas are small, you can vary waypoints (but not actions at waypoints or heights etc). Weapons loadout is a little different from the last iteration, and you have a good deal of control over wingmen and comms with tankers.

The 22 canned missions are supported by a Mission Editor which is average, but does the trick. Plan your objectives, all the variables, and so on. Each mission generated is playable as a cooperative multiplayer mission. Campaigns cover the same areas as the Quick Missions. They are imaginative, but not linked all that well together at all.

### Wobbly wheels

As far as new editions go, the B61 Tactical Thermonuclear Bomb is a blast! (Sorry I couldn't resist that). Watching your



### Sim-lite

The cold hard facts. This is a sim aimed at entertainment, not "hard core" flight sim fanatics. In keeping with the first two versions of this game, Novalogic have kept much of the interface the same. This is not to say that it is the same - it's not. I really like the way it feels. A short learning curve, backed up with some simple training missions, small mission areas, but at the same time a variety of terrain. Nevada (USA Training), Russia, Indonesia, Philippines, Sudan, Algeria and Syria. 22 canned



(above) Splash one SU-27. Not that the cockpit is similar to F2211, and now has a steering cue to the next target if you toggle it on.

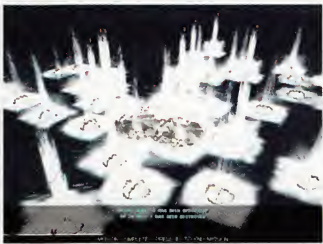

first mushroom cloud grow while listening to the low, growling delivery rumble of your nuke is quite an experience. You've also got the AGM-88 HARM, but the real difference comes in the graphical department. Rain, snow, hail, thunder,



lightning and strong winds impact on your F-22. These are supported by strong 3D sound and if you have a force feedback joystick, you really do feel them. Yes I know, the F22 is fly by wire, so there is no feedback to the pilot from the joystick in reality. But in this game it adds to the overall experience. I do think Novalogic could have removed it when taxiing and taking off though, because it feels like you are driving a \$200 supermarket trolley with a wobbly wheel, not a multimillion dollar supercomputer sitting in

front of two Pratt & Whitney F119-PW-100 35,000 pound thrust engines!

**Bad pop-up**

Visually, the ground terrain is eye candy. Mists, fog etc, and terrain textures are nicely done. The game engine runs 3dfx and D3D up to 1024x768. Explosive detonations in the air and on the ground are exciting. On the downside, the terrain in the distance "pops" into view, instead of fading in slowly. I thought we had passed the days when terrain popped up as you approached it. The problem was significant enough to take away some element of enjoyment from the game.

**Radio discipline**

Multiplayer capability is one of Novalogic's strengths, and in F22 Lightning 3 they add Voice

over Net (VON) capability. This uses your sound card, microphone and speakers at the same time as the game and I found it great in local multiplayer games. When I logged into Novaworld in the UK, it was a little difficult with everyone vying for time on the single radio channel. In Military terms you need radio discipline in these occasions, or separate nets (or channels) for different groups of players. Overall, I found this new edition very good, but in need of refinement - which is something you'd would expect in its first release.

**128 player arenas**

This is an excellent combat flight sim with a brief learning curve and exceptional graphics. NovaLogic's Novaworld adds the 128 player combat arena, and the mission generator combination means that if you give this game a chance, you will not be disappointed.

*Maj Ian Lindgren*

**PLUS+**

<http://www.edwards.af.mil/pApr98/cover/F22Main.htm>  
Have I found the Site! If you want to eat, sleep and breathe the F22 Raptor, then the USAF Edwards Airforce Base site has more than you can probably take. The F22 missions, avionics, stealth equipment, weapons, computer hardware and software....arrrrrgh! I also recommend a quick visit to [www.novalogic.com](http://www.novalogic.com) to download the F22 3 13 MB initial patch.



**85%**

- For**  
Easy learning curve, great graphics, lovely 3D sound, realistic weather effects and VON technology
- Against**  
I didn't mention it in the review, but the documentation is very limited. Most of it is in .pdf files and I find that no matter how you look at it, you just can't refer to these when flying. I also disliked the distance graphics
- Need**  
P200 with 32 MB RAM
- Want**  
PII with 64 MB RAM and 3D card

**3D SUPPORT**  
Direct3D and 3dfx

# CORSAIRS

Genre: Real time Strategy | Players: 1 | Developer: Microids | Publisher: Microids | Price: \$TBA | Rating: G | Available: Now

Expanding your empire with might and muscle? Sounds like a strategy game then. What's with the blokes in pyjamas though?

**S**o you're looking at this page and seeing plenty of images of pirates and swashbuckling sea vessels in combat, sailing on the high seas. Perhaps you're familiar with this genre of gaming known as strategy and you may have also played one of a number of real-time strategy games available that seduce you into 'role playing' various conquering warlords and generals. What value you may find in this new title from Microids, (a French software company), is not something new in terms of gameplay, but in the delight of playing a strategy game as a wily general (Corsair) of the French navel fleet whose task it is to further the ambitions of the French Empire. In the course of your journeys you will traverse



such places as the Caribbean islands, the Australian coast, Madagascar and the Indian Ocean, and you will find yourself in conflict with the Spanish, English, Dutch and of course the occasional pirate or two (did somebody mention Blackbeard?). Anyway, quite a diverse collection so lets take a look...

## Power and influence

The game itself is broken up into separate adventures that you must complete in sequence before moving onto the next adventure. Within any adventure you are to follow a couple of general mission orders given by the regional governors, and for the rest of the time, you essentially increase your personal wealth and power as you see fit. This amounts to accumulating gold and other goods (spices, silk, copper, etc) to trade with local provinces and further



(above) With cutlasses brandished at their sides, the Cartier crew proved a smash hit at the annual French Navy Formation Dancing Ball.



increase your influence. The game map itself is specific to each mission and is represented by a small graphic in the interface bar. As you travel around you open up what is commonly referred to as the "fog of war". In the case of Corsairs, this resembles an old parched map that opens up as you move into any given area of the overall map. As you travel around, you encounter both neutral and hostile forces represented by both ships on the seas or ports on

land. If you encounter other forces and they are hostile, you may engage them in cannon fire. Each of your ships is heavily armed with various cannonballs ranging from standard hull

crushing projectiles to shrapnel-like personnel killers. If you wish to increase your fleet then you may opt to board the enemy and engage them in hand-to-hand combat in order to capture their ship. This manoeuvre switches game play to a bird's eye view of the two ships as you engage the enemy. If you have enough men then the enemy ship is yours. If you wish, you can leave this action to the computer and the views don't change from the standard interface. Success in capture then becomes a matter of numbers. In order to capture a port (which can furnish your coffers quite substantially), the process is the







same, with its only difference being scenic – land replaces the enemy ship in the action plane.

**Trade or Combat**

At the beginning of each mission you begin with a single vessel, and by course of either trade or combat you build up your forces to accomplish the given tasks. By travelling through the islands of the map you encounter plenty of foes that provide you with the chance to increase your power. In terms of the vessels themselves, they range in combat status quite significantly from your basic Luggar through to the formidable Corvette, a ship that can practically conquer a port all by itself. The strength of a vessel also determines its speed, which translates into somewhat of a concern for sea battles if your fleet consists of a wide range of vessels. Smaller and less manned vessels will fall behind their larger cousins and often get captured by the enemy ships. Wind also plays an important role, as you will find travelling upwind quite difficult compared with the opposite.

**Basic upgrades**

Corsairs is primarily a sailing/sea combat simulation, although there are certain moments in the game that allow you to contribute to the construction of the ports. These involve port upgrades and repairs after an enemy has attacked and provide no more benefit to your endeavours aside from the fact that you will have a safe harbour to moor in, and dry dock upgrades enable you to build better ships. This is somewhat of a shame considering how little actually happens in the harbours while you are docked. There is very little ani-



mation onshore and most of the harbours follow a very similar architecture – even between cultures. But how can I be critical of this if its emphasis is sea-faring action? Put simply, most of the game is spent following shorelines with very little scenic eye candy along the way and, harbours that all pretty much look the same.

**No multiplayer?**

Ok, so you have managed to find a couple of swashbuckling enthusiasts who want to have endless hours of sword clashing fun with you? Then forget Corsairs. That's right - NO MULTIPLAY. What was Microids thinking? It's bad enough that computer gaming AI usually leaves much to be desired, but with no multiplayer, the features included in this game are somewhat telling of the extent to which this game can hold your attention. In short, after half an hour of multiplayer (if they included it) participants would become bored with simply stealing ships and ports off each other. It kind of makes sense that it wasn't included. The heart of this game lies in missions and as we've mentioned before, any given mission doesn't actually entail very many requirements so you have to busy yourself with straightforward

It's a little known fact, but galleons of olde were often twice the size of the largest buildings in any given city.

theft and even more straightforward conquering.

**Standard stuff**

Beginning with the tutorials as a way to familiarize myself with the game, I was quite disappointed with the interface itself. It is quite confusing until you get used to its nuances. There were more problems along the line with its restricting design that made what should have been simple tasks quite click intensive. That aside, play is generally quite enjoyable and does present certain challenges along the way. There is not much of a learning curve however, and working out how to obtain the best vessels quickly reveals itself as the only real strategy. Once implemented, the missions are quite simple to complete. Overall, Corsairs can be quite an enjoyable buccaneer experience, but not something that I would revisit with any kind of zeal.

Jhar



**PLUS+**

Legends

Pirates & Privateers

<http://legends.dm.net/pirates/drake.html>

The stuff legends are made of.

**65%**

**For**  
Corsairs is a refreshing variation in the realtime strategy genre, and quite absorbing once you get familiar with its interface. The graphics are acceptable although not spectacular, and the sound score is quite uplifting.

**Against**  
Lack of more compelling mission objectives and with no multiplayer capabilities Corsairs is a little disappointing if your favour is offing your friends in sea combat.

**Need**  
P133, 32MB RAM, 100MB HDD, Win.9x.

**Want**  
PII, 64MB RAM



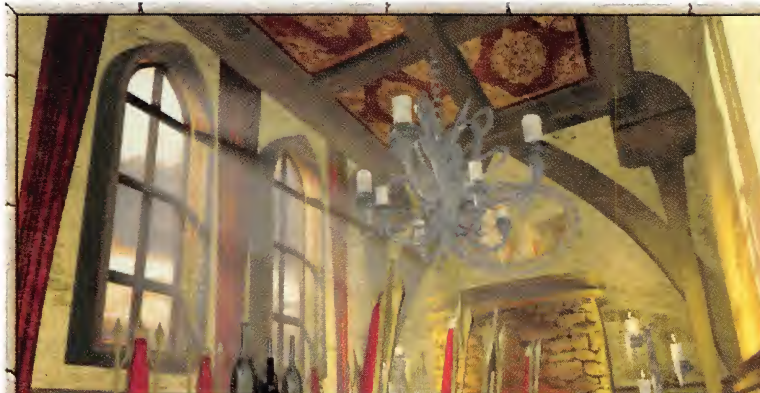

*There is a breed of Medusa infesting the Red Dwarf Mines that is immune to magic. These monsters are a real terror! I can only thank the Gods that these creatures haven't escaped the mine. What would we do then, beat them to death with our staves?*

Exit Building



Summer

Medusas

(left) Hmm... Medusa infesting the mines? Do you think they might want me to go and kill them all?



PCPP: What do you think of the allegedly enhanced visual side of the game?

Prumpy: With the added 3D accelerator support, I think there's a definite improvement in the graphics. Overall the textures have had their rough edges smoothed out and the speed increase is noticeable. Elsewhere, the coloured lighting effects, especially in the dungeons, buildings and other enclosed spaces, just look really pretty. Blasting a fireball down a torchlit cave is a sight to behold.

PCPP: True. Though I'd suggest the 3D engine still lags considerably behind many other games. The sprite-based characters, too, are not only anachronistic in this polygon age but both animate and pixellate quite atrociously.

Prumpy: Yes, I see your



something you can use to your advantage - and it looks cool. Besides, how smart do you think a pack of subterranean troglodytes actually are?

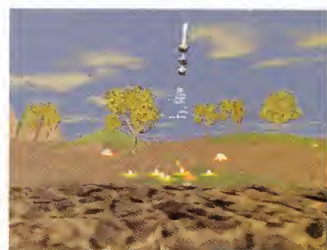

game slightly back towards "might", though undoubtedly "magic" still dominates. Having said that, you really need either a party who can all engage in melee attacks (knight, paladin, monk, ranger) or one where all possess excellent ranged combat skills (archer, thief, ranger, and any of the spellcasters). Otherwise the required balance just isn't there. Of course, there are loads of new spells, items, weapons, armour, and a huge influx of creatures from Heroes of Might & Magic 3.

Allowing a movement round in turn-based combat certainly adds to the repertoire of available strategy as well.

PCPP: You make some valid points there. I'd only query the improvements to combat. In my experience, the monsters remain as dense as ever; regularly have I seen them topple over cliffs and get stuck behind objects whilst pursuing my party.

Prumpy: But they do fight amongst each other now. That's



This is Arcomage, the card game played in taverns throughout Erathia. It also forms the basis for one of the more entertaining quests.



point. The creatures do appear unpleasant when seen up close, but then have you ever stood toe-to-toe with a swamp troll? They really are hideous. Anyway, haven't RPGs always been about more than cosmetics? In gameplay terms, this is one heck of an adventure. So many caves and dungeons and temples and mansions to plunder for gold and glory, countless subquests in which to valiantly partake, hordes upon hordes of vile monsters to bludgeon and vanquish, and for me a great many old friends with whom to catch up. Ah, it's truly fantasy role-playing at its very best.

PCPP: I don't know, I tend to think it's more role-playing pared down to its bare essentials. For instance, all the people you meet come in two categories. Either they bluntly offer their services as a merchant, locksmith, teacher, etc to increase your party's stats or they send you on a quest that usually involves hacking through a dungeon to retrieve some lost item or ferrying another item to someone else. You feel more like an errand boy than a group of heroes.

Prumpy: There's a significant element of that sort of thing. However, it's more than compensated, I feel, by the sheer thrill of exploration, of discovering each new land, each new

city, each new dungeon. Across the world of Erathia, there's an incredible amount of variety in the races of the inhabitants and the terrain in which they live. It's fun just viewing it all. Also, I'd like to mention the



(above left) See those two Ghosts at the top of the staircase? If you stay still they get stuck there, allowing you to kill them with ease.



unique scenario where early into the game the player will become the Lord of Harmondale, acquiring a castle and becoming involved in the politics of the realm in the process.

PCPP: Sure, it is a clever idea and one that mostly works well. Sadly, I did feel a tinge of disappointment, though, when I was finally granted an audience with Queen Catherine and the first and only thing she said to me was to send me on a quest. Sigh. That's indicative of the game as a whole; it promises so much, yet never seems to get around to delivering it.

Prumpy: Bah! You've just got way too highly inflated expectations. Might & Magic games are always huge in scope and size, but rarely in depth of interaction. While even a hardened head-cleaver like myself can understand how someone could find the hack and slash approach of much of the gameplay a tad on the tedious side...

PCPP: Oh, Prumpy, how generous.

Prumpy: Don't push it, you yellow-bellied, limp-wristed elf.

PCPP: Thanks for your time, you diminutive, slapped-arse faced, wizened old fool...

Prumpy: Why you young whippersnapper! I'll snap off those gangly limbs of yours and use them as toothpicks...!

David Wildgoose

PCPP'S SCORE

70%

■ For

Generally, the interface flexibility and the graphics and sound quality have all been slightly improved. Elsewhere, the skill system is pleasingly complex and the castle-ownership plot device manages to be both credible and interesting.

■ Against

It's really quite torturously long. You'll probably be heartily sick of the tedious trekking around before you even get halfway through. Cretinously simple monster AI seems to be the reason for the sheer number of creatures you must hack through to get anywhere; it wouldn't be challenging otherwise, you see.

■ Need

P133, 32MB RAM

■ Want

P200, 64MB RAM, 3D card

PRUMPY'S SCORE

90%

■ For

All the adventuring you could wish for. Quests, monsters, spell, magic items and bloody big axes in their thousands. Oh, and you get to slice the heads off hundreds of goblins while you're at it.

■ Against

Too long? Damn, there's not enough of it! Give me more blood, more gold, more axes, more of those puny goblins!

■ Need

A lengthy beard, a suit of fine dwarven chainmail, and a bloody big axe.

■ Want

Several mugs of foaming ale from The Snobbish Goblin.

PLUS+

Medieval German Battle Axe



The axe is made of high quality, tempered steel and is a true work of art. It is a true work of art and is a true work of art.



To view the collection of a medieval weapons hobbyist, visit <http://www.iohio.com/joxer/weapons>. Prumpy would approve.

# DEMOS OF ALL THE BEST GAMES!!

**PC PowerPlay** ISSUE 7 \$4.95 (NZ \$6.95 incl. GST) **TWIN CD PACK!**

**PC Games** BEST OF **ROLE PLAY GAMES**

DUNGEONS AND DRAGONS!  
SWORDS AND SORCERY!

**ALL THESE GAMES!**  
BALDUR'S GATE (WHOPPING 400 MEG DEMO)  
(166 MEG DEMO) • FINAL FANTASY 7 (150 MEG DEMO)  
HEROES OF MIB3 (100 MEG DEMO) • DIABLO  
OVER 1 GIG WORTH OF GAMES

**PC PowerPlay** ISSUE 5 \$4.95 (NZ \$6.95 incl. GST) **TWIN CD PACK!**

**PC Games** BEST OF **STRATEGY**

THE GREATEST STRATEGY  
GAME DEMOS

**CD1** INCLUDING:  
Red Alert  
Starcraft

**PLUS MANY MORE!**  
Age of Empires: The Rise and Fall  
Beginning • Railroad Tycoon  
• Sid Meier's Alpha Centauri  
• Rollercoaster Tycoon

**PC PowerPlay** ISSUE 6 \$4.95 (NZ \$6.95 incl. GST) **TWIN CD PACK!**

**PC Games** BEST OF **ACTION**

HARD-HITTING THRILLERS  
FOR YOUR PC!

**CD1 CD2** INCLUDING:  
Sin  
Thief  
Aliens vs. Predator

**PLUS MANY MORE!**  
BLOOD II • DAIKATANA • DESCENT  
• KLINGON HONOR GUARD • MECHANICAL  
• SHOGO: MOBILE ARMOUR DEMO  
AND MANY MORE!

**PC PowerPlay** ISSUE 3 \$4.95 (NZ \$6.95 incl. GST) **TWIN CD PACK!**

**PC Games** BEST OF **ADVENTURE**

OVER 640 MB OF THE BEST  
ADVENTURE DEMOS

**CD1 CD2** INCLUDING:  
Tomb Raider 3  
Resident Evil 2  
Grim Fandango  
Heart of Darkness

**PLUS MANY MORE!**  
Ashgan • Broken Sword 2 • Curse Of Monkey Island  
Die By The Sword • FF7 • Kings Quest 8 • LBA 2  
Montezuma's Revenge • Nightlong  
Sanitarium • Quest For Glory 5 • Thief • Yoda Stories

# OUT NOW!

# ANNO 1602

Genre: Real time strategy | Players: 1-4 (TCP/IP, IPX) | Developer: Sunflowers | Publisher: GT Interactive | Price: \$TBA | Rating: G | Available: Now

Come embrace the life of merry seamen.

**F**irst impressions can be unreliable. Hearing about a Civilizationesque title that makes a fuss over the high seas, piracies and such, put me in mind of a Gilbert & Sullivan production. Good fun and all that, but not particularly serious. But please, give it a chance. Anno 1602 is not a disappointing game at all. It's more, shall we say, reliable. So raise the jolly roger and set sail for an era of bravery, sea-sickness and illiteracy.

### Long distance prosperity

The story is very straightforward. Leave your homeland with vessels and supplies to look for prosperity in distant lands. When you find a suitable location, establish a warehouse and go about building a community. Do this a lot. You must also interact with your neighbouring communities. This can include diplomacy that will naturally lead to trade agreements. As an alternative, you may wish to blow them to smithereens, like the tyrant that you are.

The game has quite a lot to offer in gameplay options. Apart from the tutorial, you have three distinct modes of play. The first is a free play option which is just an open ended affair, where you build, sail and conquer without any requirements placed on you. The second are the various campaigns (that are rated according to difficulty) that test your skills against the game's AI. The last is multiplayer that will pit you against other humans (or young males anyway).



### Satisfying interface

The interface is quite satisfying and it recalls a recent super game, namely Civilization: Call to Power. Anno 1602 is very much icon based and is clear and easily comprehensible.



There isn't an obvious way to quit the game however. You select the mode that you wish to give orders in, namely battle, construction or status. You can direct your forces from there. By selecting different features in your empire, other aspects are revealed. Trade forms a big part of the action.

### Diplomatic trade

Trading goods is of particular importance since the production of important buildings in your little empire, require some important resources. Early on this is metal ore deposits. You would be wise to not settle an island that didn't have an ore deposit of use to you. As you progress through the game, you find that you need resources for trade or domestic consumption that your own island cannot produce. This is where you must consider trading with other



(top) By arranging his colony in perfect grid formation, John sinks to new levels of anality.

colonies. Trade routes must first be established by having a trade agreement. Word to the wise: you can't trade with someone you are fighting. This is where diplomatic relations become important. Once a trade agreement has been reached, it's a matter of organising transportation. You just have to select a ship to carry out the exchange of goods.

### Good ol' capitalism

Nothing is safe on the high seas so you're going to have to consider protection. You can have an escort ship protect your trade routes by setting up way points. The foes you may come up against are other colonies or even pirates. Pirates can be





Another Civ-meets-Settlers strategy game. There's not a lot to say really. Yawn...

bought off however. So basically the game involves the accumulation of wealth and its protection.

**Lacking in depth**

It's a basically solid concept but there are some problems with Anno 1602. The level of depth in other strategy games such as Alpha Centauri is distinctly lacking. Since you are essentially set in that colonising-a-New-World era, there is no evidence of scientific development and hence little chance to upgrade your units. Management of civic affairs reaches as far as making sure the right buildings are around to produce the goods you need for building and keeping your population happy. There is a lot to doing this properly but I didn't find it particularly compelling just building another plantation for trade.

**AI issues**

This lack of a depth also extends to combat. Combat involves directing your ships around to particular positions and attacking the craft of the



enemy. You should be able to organise different armadas to attack different targets but your ships really need to be monitored at all times, and so simultaneous attacks around the entire map aren't really feasible. Ground troops too feature the basic point and click fashion of attacking. Distressingly, I found that when being attacked some units don't even defend themselves! There is good gameplay in Anno 1602, but not the general appeal that will draw a lot of gamers to it.

**Cheap Thrills**

There are enough nice touches to keep you happy: your crew yelling "ay-ay, sir!" when given an order, the dolphins leaping from the water, the giant sea monsters that occasionally surface to look ominous (I've never



seen one devour a ship however sadly) and giant whales that cruise around. The music too is authentic enough, in that John-Brown-Body-tin-whistle fashion, but can become a little tiresome. The game is agreeable enough to offer the gamer some good gameplay but I'm unconvinced of its long term value to the strategy gamer.

**Competent gaming**

Anno 1602 is a great offering when you consider that it is a fairly complete title that explores well its premise of naval expedition and settling new continents. I found it surprising how good it actually was from first impressions. In the end though, it doesn't really stack up to the games it tries to emulate. Competent gaming for those craving the high seas.

*John Dewhurst*



**PLUS+**

The Book Garden Gallery

Visit the BookGarden to learn more about 17th Century agriculture [www.bookgarden.com](http://www.bookgarden.com)

**71%**

- For: Competent RTS gaming, heavy on trading, nice music and whales!
- Against: Lacks depth generally which limits the replay value.
- Need: P100, Win95, 2MB PCI graphics card, 16 MB RAM
- Want: P166, 32MB RAM



# MAN OF WAR II

Genre: Strategy | Players: 1-Multi | Developer: StrategyFirst | Publisher: StrategyFirst | Price: \$TBA | Rating: G | Available: Now

What is it with nautically themed strategy games this month? Will the madness ever end?

**W**hat can be said about this dismal contribution from the Canadian software company StrategyFirst except this – what were they thinking? The fact that this title is a sequel astonishes me, for this usually implies a certain success in the first incarnation to justify the production of a follow up title. That said, Man of War II is an unusual take on the strategy genre with most of the game played in first-person 3D aboard an 18th Century English war vessel. Your task is to command either a fleet of ships, division (part thereof), or single vessel against an army of enemy vessels. Perhaps this makes for something different, something fresh I hear you think? Well - forget it! I'm not usually one to judge the quality of a game by its appearance over game play, and in this case I won't because I have something negative to say about both.

## Square

That's right, the graphics are square and I know for a fact that a computer doesn't have a lot of trouble computing the three dimensions of a cube, but in this case, it's literally amaz-

ing how two dimensional this game looks. Its only claim to special depth is that objects in the distance are smaller than those in the foreground. After that, everything about the appearance of this game reminds me of the classic Wolfenstein 3D (and my apologies for even putting the two games together in the same sentence). It's not that surprising after looking at the credits list and discovering that more people worked on the manual (which is practically a novella) than the art.

## It is a game right?

Oh yes, I almost forgot... This is a game and I'm supposed to be having fun! Well, after spending a lot of time reading the manual and scratching my head, I concluded that the developers must think that wondering around a ships deck is entertaining enough, and that there shouldn't be much more to do than click a little button that (from time to time) apparently fires cannons (even though I didn't see much of that). All that while I'm enjoying the scenery.



"HELPI Cap'n, they've got us surrounded by a horrible dotted line - and it's closing in fast...!"

## Yuck

Perhaps I'm being a little harsh? I imagine that there must be someone out there who would get some kind of satisfaction out of this game's historical accuracy at least. Also, and before I forget (and that's, with any luck, as fast as possible), the game also supports multiplayer. So if you are a English naval specialist, and have a friend (at all) get this dribble and knock yourselves out!

Jhar



96 PC PowerPlay

PLUS+



[www.worldshiptrust.org/](http://www.worldshiptrust.org/)

15%

### ■ For

I'm sure this will entertain someone's fantasy... No seriously, the soundtrack's not bad if you're into sailing music.

### ■ Against

Bad visuals. No engaging game play. Features a longwinded, but painfully necessary manual, given that the interface is completely nonsensical. And to top it off, it's an example of how not to make a strategy game in first-person perspective.

### ■ Need

P120, 32MB RAM, Win 9x

### ■ Want

P2, 64MB RAM



# PC GAMEGUIDE

There's developers all across the

world working hard every day and night



for years to get their

games made right. They put a hell of a lot of work in to them,

and they make 'em tough. That's where PC GameGuide comes

in. We've got



everything you'll ever need, and more.



## WALKTHROUGHS!

You'll find more than your average walkthroughs in PC GameGuide -

we do so much more than the usual "go here, turn left, kill baddie". Once you've read one of our

playguides you'll know everything there is to know about that game.



## TIPS!

But it's not just

walkthroughs that we pride ourselves on. General tips, gaming help, and strategies for a huge variety of

games are covered



in every issue.

## HINTS!

All the hints to get you through the hard bits in all

the cool games. If you want it, we'll have it.

## SECRETS!

Because we go beyond the traditional 'walk-

throughs', you'll find out about all the secrets in the games, and you'll know



where all the weird

stuff happens.

## PLAYGUIDES!

In short, there's

enough material in every issue to allow you to live your

gaming lifestyle to the fullest. Live your life the way you

want, with **PC GAMEGUIDE** at your side.



# Retroversion

What defines a classic game? It's one that you're still playing months after release. It's one in which you're still discovering new aspects and of which you're still trying to perfect your mastery. Here's another one...

## Total Annihilation

**T**otal Annihilation is synonymous with brilliant real-time strategy gaming bliss. I have fond memories of TA. Late nights filled with amazing, drawn out, battles. Strategically designed bases and tactically commanded forces. Allies screaming for help. Enemies screaming for mercy. Total Annihilation all around. Awesome fun.

### This is real-time, baby

Cavedog entered the scene with an all-time classic. TA revolutionised the RTS genre by breaking away for the first time from the popular sprite based RTS model. Sprites, while allowing pretty graphics, can be limiting. Units that use sprites are restricted by the number of sprites that represent movement directions, damage effects, weapon animation and so on. There was nothing wrong with this until we tasted the new breed of gaming that Total Annihilation offered - real time rendered graphics. Units and buildings weren't sprites, they were drawn real time. Every step, every recoil from a cannon, every turn - complete freedom of movement in any direction.

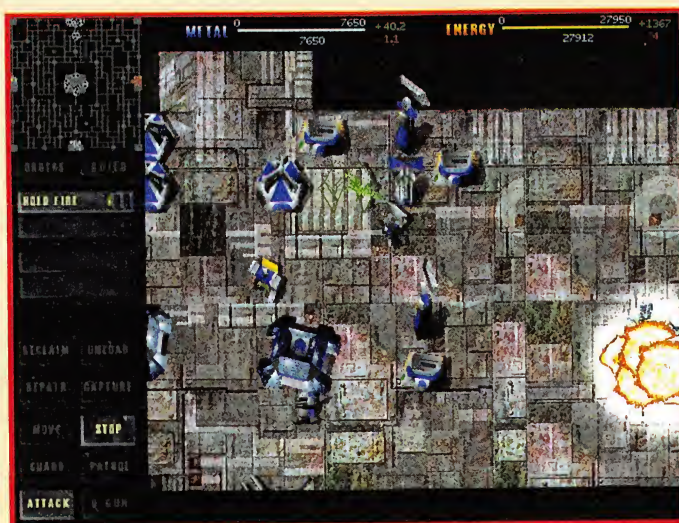

Even buildings were drawn at differing angles, adding spice to bases since no two bases would ever look the same.

There was nothing quite like sending an airborne scout out over the terrain on a patrol mission and watching its turning arc, the speed slowing, the wings tilting, and accelerating again on a new heading. Smooth and graceful. No wonder the huge battles that players could have with hundreds of real-time rendered



units made TA such a hit. These battles were spectacular - units moving and firing at all angles, dodging around wreckage, trying to out-think and out-blast their opponents. It was enough to cause gamers to re-prioritise their lives. You knew you were hooked when you started to relate to your peers as kbots.

### Scaling great heights

More than this, because all units and buildings in the game

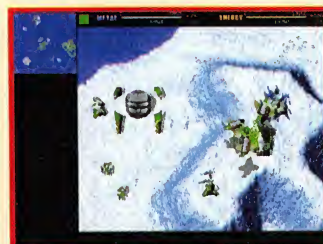

are rendered, TA can play at any resolution from 640x480 to 1280x1024 and beyond. Scaling the game screen and the graphics therein is extremely simple when you're drawing everything in real-time. Games that use sprites, however, can't do this without losing quality in the sprite images. Overall the TA engine was a fantastic concept that was brilliantly implemented.

As if this wasn't enough, Cavedog thought long and hard about how RTS games are played. TA featured a very intuitive key setup and queue system that allowed you to easily queue tasks for units, thereby speeding base growth, easing patrol missions, and adding immense depth to tactical manoeuvres. Combine this with true line of sight (the only game at the time to implement it correctly, despite claims of the same feature from its competitors) and terrain height, and you have a game that allows an RTS player to have complete tactical and strategic freedom in a dynamic, battle

REVIEWED: Issue 18

SCORED: 98%

WHAT WE SAID THEN: This game is incredible. Until you see it in action, you can't imagine the beauty of this game. This is what real-time strategy gaming should have been from the start.

All hail the new king!



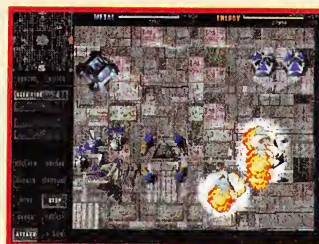
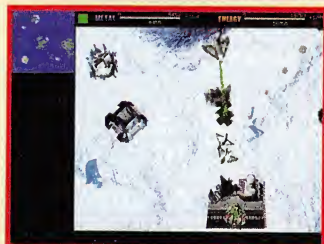

realistic environment. No wonder I remained addicted to this game, even a year after it was released. Nice one, Cavedog.

**Breeding units like rabbits**

Now, on the off chance that you might start getting bored with the myriad of units that come with TA, Cavedog started to regularly release new units once a week, adding a new dimension to the game. New unit types meant new tactics for the aggressor and called for new counter-tactics for the defender. Continually adding to the game this way created an unlimited strategic resource with the vast array of units allowing a commander to attempt victory in a variety of ways. Speaking of which, the units were also superbly balanced; you couldn't win the game by just pumping out one unit type, as victory required a careful management of ground, sea, and air resources. And of resources, powerful units and weapons required both time and energy to complete. If you wanted to beat your enemy into submission with a Bertha, you had to spend a heck of a long time building it. This realistic design allowed gamers to explore all types of strategies, gaining victory from numbers, technology, or both.

**Prized Bertha**

Everyone had their favourite unit. Despite the gloriousness of the Gunship or the trusty Fido, the Bertha was my most prized. Ever since I first saw it fire I thought I had reached RTS heaven. Sure, it took a long time to build, but in capable hands this weapon could turn the tide of battle. On large maps the Bertha's range,



while extensive, wasn't nearly far enough. And so I created the radar cloaked Bertha camp. Find a convenient location, send construction bots with radar jammers and a small escort, and start building Big Bertha. Throw down a couple of turrets and even if your opponent manages to discover the camp, they'd need a small force to take it out of action. If they

didn't do so before construction finished and they let you get away with this feat of strategic engineering, they deserved the devastation that would follow. Which is why it's always good to build two such camps. Or three.

**Reunite with old pals**

And what about the Core Contingency? New maps, new missions and lots of new units - hovercraft, underwater bases, expanded fleets and more. TA has covered the RTS genre - and still does - like no other. Where else can you combine a force of hundreds of unit types ranging from air to land to sea to hover to underwater? What about base weapons ranging from humble missile towers to Berthas to nukes? And unit classes such as transports, missile tanks, bombers, stealth fighters, radar jammers, scouts, massive war ships, amphibious units, snipers, big tanks, small tanks, super weapons, walls, spider craft, anti-air bots, gunships, fighters, missile boats, pyro units, cloaking power sources, construction bots, laser turrets, the commander and so much more.

It's been too long since my last game. I think it's about time I revisited my old friend, and about time I pummelled my pals into metallic mush. Anyone up for a game?

*Ashton Mills*

**PLUS<sup>+</sup>**  
**TOTAL ANNIHILATION**

**MODS**

Collection of all Cavedog released units

Cavedog:  
[www.cavedog.com/totala/units.html](http://www.cavedog.com/totala/units.html)

Collection of all Cavedog released maps

Cavedog:  
[www.cavedog.com/totala/maps.html](http://www.cavedog.com/totala/maps.html)

Best Collection of third party released units and maps:

TADD:  
[www.tadd.org/](http://www.tadd.org/)  
TAMMO:  
[www.tammo.com/](http://www.tammo.com/)  
TAUCC:  
[www.taucc.com/](http://www.taucc.com/)

Star Wars conversion  
<http://tak.telefragged.com/theforce/>



**OFFICIAL UPGRADES**

Total Annihilation: The Core Contingency  
Cavedog:  
[www.cavedog.com](http://www.cavedog.com)

**LATEST PATCH**

TA 3.1:  
[www.cavedog.com/totala/exes.html](http://www.cavedog.com/totala/exes.html)

**NUMBER ONE FAN WEB SITE**

Annihilated.com:  
<http://www.annihilated.com>



# Diversions

## STAR WARS EPISODE 1 - INSIDER'S GUIDE

Genre: Encarta-style film information and multimedia encyclopedia | Publisher: LucasArts | Price: \$TBA | Rating: G | Available: Now

Lucasarts magic gets a thorough medical exam for your viewing pleasure. No single crevice goes uninvaded!



There's a certain kind of people who will stop at nothing to gather details. In their chosen subject of interest, they know almost everything, yet they slavishly scramble and search for more details, more raw data to add to their knowledge. Often their frenzied mission reduces the time they can devote to social activities. Most of these people are mad. The others are scientists and obscure specialised engineers. As an alternative, some of them have chosen Star Wars as their "king topic". These secondary characters will probably never make a lot of money out of their Star Wars expertise, or get a Government grant to further research, but damn it, they know bloody everything about the Star Wars universe. These are the nameless characters who spent weeks waiting in line for opening session tickets, clad in their complete Darth Vader outfit, shivering in a sleeping bag on concrete in 5 degree temperatures. These people, in particular will make a gibbering mess of themselves over this CD-ROM set.



### Comprehensive speculation

It's a big, chunky, comprehensive catalog of absolutely everything the Phantom Menace served and spawned. It's as visceral as footage and photos from the sets of the film during the making, and sound bytes from segments of the film. It's as deep as full concept art for each main character or creature, with notes on how the design was changed when it was discovered an idea didn't work very well. It also goes as far as cute speculation over the storylines that the final two films will cover, and TV-week style rumours about the actors that will play the roles in the upcoming films. For example Leonardo DiCaprio is widely believed to be playing the part of Anakin Skywalker in the next film, starring in some heavy lovemaking scenes with his main love interest, who will be reliving his role from the first film: the rubbery frog-mutant Jar-Jar Binks. This coy reptile has expressed delight in working with the slender young heart-throb, and added coyly that the two of them have a lot to discover about each other's bodies

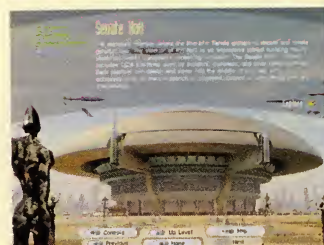
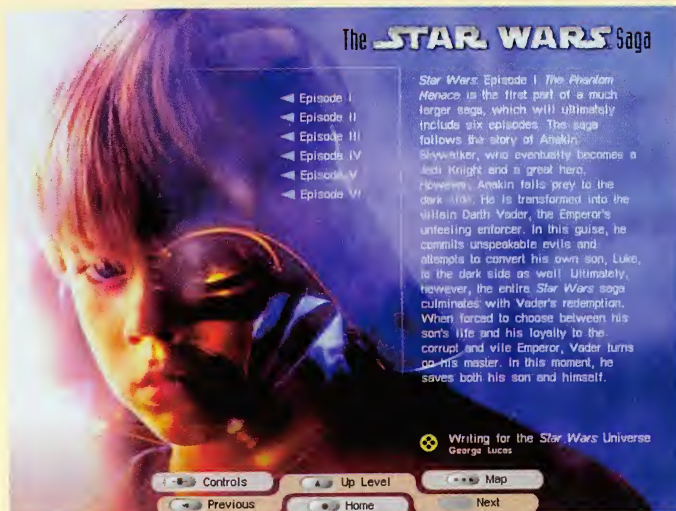

(main) Insightful piece of trivia 1: Little Darth developed asthma on the dusty world of Tatooine, an affliction that would trouble his adult life.



before shooting begins.

Everything the rabid, foaming, incoherent Star Wars enthusiast could ever want and need in terms of Phantom Menace information, is packed onto two CD-ROMs.

### Toy crazy

Of particular note to the hardcore fans is a total toy database, listing every, single, total piece of Star Wars plastic figurine merchandise relating to the first film. This really has to be seen to be believed. There is a mind-blowing array of figurines, vehicles, and life-size plastic lightsabres to be had. For example there are "scene sets" which are little modelled bits of land-

scape and buildings wedged onto a round base, with all of the characters and equipment from the scene. Now think of how many scenes there are in the film. Oh, yes.

Of course there's the range of ten or so big lightsabres, in a range of retractable, solid and light-up variations. The Pod Racing scene has generated a massive spin-off set of toys by itself: there are little matchbox-sized ones with wheels that can be fired out of a special launcher,



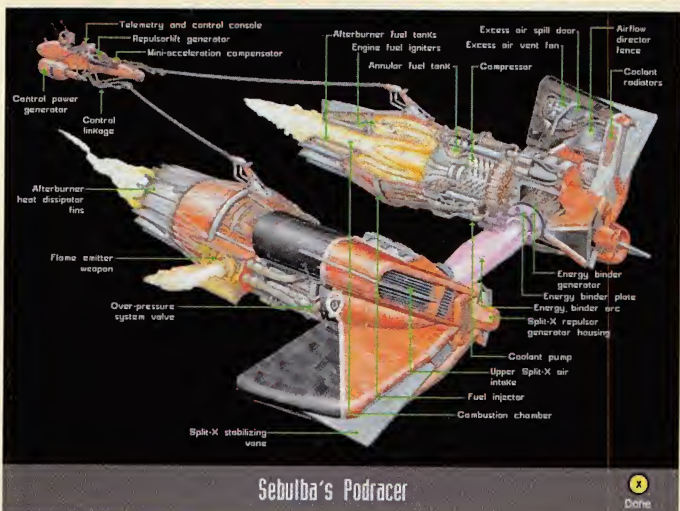

there's a full-on slot racing style kit with little pod racing slot cars, there's just everything you can think of and more. But amazing as it all is, the probable cake-taker is the "Queen Amidala Ultimate HAIR Doll"! No joke. It's a Barbie/Malibu Stacey contraption with "big" hair that can be styled with tiny curlers and sticky gel stuff. Now the young lady fans can sculpt their favourite Queen's head into an array of the most un-Queen like bodacious hairstyles. Queen Amidala with a shaved head might be cute? Or Dreads. Funky blonde Dreadlocks?

**Half-baked**

There is a fairly hefty accompaniment of information on each piece of technology, equipment and culture. Even character's backgrounds and history are explained in a fairly creative couple of pages. This stuff was fairly obviously "cooked up" for this CD-ROM kit, so it's not particularly enlightening stuff.

The information could quite easily be invented in a self-congratulatory pseudoscientific rant based on arrogant speculation. None of it holds the exacting

tone that real science text does: it reads more like a handbook for Dungeons & Dragons.

"A Halberd is a long, straight pole with an axe on the end. Many proud dwarves from Illumicandia used to parade these with yellow scarves tied at the top, to signify their virility and deep respect for cottage cheese."

Sure, it's information no-one can refute, but if the inventor decided to change their entire way of thinking halfway through the concept without stopping to re-write anything, the results would have been much the same. It's fairly lightweight dribble, probably penned by average fiction writers who are given licence to explain every unexplored nuance of the series with spurious flights of fancy.

**Priceless detail**

The artwork, sounds and footage though, are simply priceless. There are numerous interesting biological sketches of creatures in the film. Reams of concept sketches, chronicling the lengthy creative journeys taken in refining the appearance of any given thing in the film. The visual conception process is out-



(top) Insightful piece of trivia 2: It is believed every single email address in the world received the "Top ten lines Sam Jackson says in The Phantom Menace"

standing; the incredible attention given to building realistic visual structures to underlie every single craft and creature is the mind-boggling part.

The architecture of each building and space seems easily detailed and feasible enough for builders to start pouring concrete. Every animal has their skeleton and muscles so impeccably laid

**Spoilers**

Seeing all this amazing information comes at a bit of a cost though, it shatters the suspension of disbelief completely. It's like seeing the simple solution to a magic trick, you'll never really appreciate the subterfuge again. True believers may find their quest for knowledge was not worth losing their blissfully inno-

**"I WILL NOT CONDONE A COURSE OF ACTION THAT WILL LEAD US TO MOUSSE."**

out, that a convincing x-ray would leave veterinarians shaking their heads. Likewise the device and vehicle schematics look as though they could be filled out with stuff from Tandy electronics. Bit of solder, two or three resistors and hey presto, it's an automated pasta-mixing spoon.

cent enjoyment. The real-life, film-set engineering is certainly very interesting, but it also gives a frightening glimpse into the combined leviathanic total of years of man-hours in painstakingly boring work that thousands of faceless industry grunts toiled at to achieve these fine results. And that kind of spoils it.

Fans will dribble themselves to sleep before they even look at half of the information here. It's a collectors item for hardcore fans who want to peer behind the stage curtain and see the magical mechanics by the light of day.

Ed Dawson

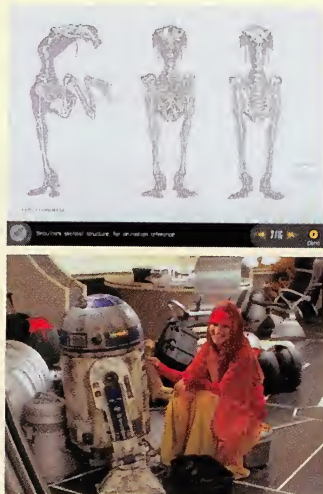

**PLUS<sup>+</sup>**  
 STAR WARS  
 LIGHTSABRES  
 UPDATES  
 www.synicon.com.au/sw/lis/sabres.htm

# ORACLE

Atop the highest peak of the highest mountain, he sits and plays games, pausing only momentarily to contemplate the universe...

The Oracle is a Wisdom Dispensing Service. He cannot abide cheaters. Write to him at:

**Oracle**

**PC PowerPlay**

**78 Renwick st**

**Redfern**

**NSW 2016**

**oracle@pcpowerplay.next.com.au**

## The Secret of Monkey Island

**?** I have a bundle of problems with the Monkey Island Madness series (which either shows I'm hopeless or impatient).

1. How do I go about countering the swordmaster's insults. The rest of the pirates just complain.

2. How do I dispose of the dogs outside the mansion (and does it have something to do with the prisoner's carrot cake, which I haven't got).

**Anonymous  
Somewhere**

**\*** Hopeless or impatient? I'd rather suspect it to be both, my nameless friend. As for your other problems, you just need to show persistence to defeat the swordmaster. Practice your insults with the other pirates until you've accumulated enough responses. The dogs, meanwhile, don't respond too well to having their food poisoned. Get the meat from the Scumm Bar's kitchen and the yellow flower from the woods, and I'll leave the rest to your imagination.

## The Curse of Monkey Island

**?** Where do I get the shaving cream for the fake pie in part six?

**Matthew Watson  
Bunbury, WA**

**\*** I'm at a bit of a loss as to how you could have missed it, Matthew. You ought to have virtually tripped over a bottle of the sticky white concoction on the beach at the start of Part IV. Other than that, there's not a lot else I can say.

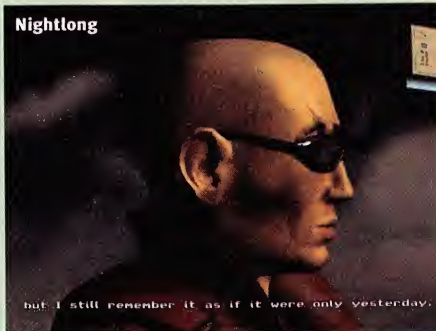
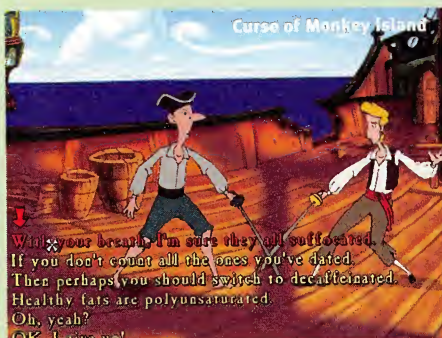

## Nightlong

**?** I'm stuck in Nightlong. I've reached the terrorists' hideout and I can't figure out the security code on the panel near the elevator. I do have the access card, but can't figure out how to shut down the system.

**Terrance Mulley  
Morningside, QLD**

**\*** Ah, Nightlong. A much underrated game, albeit a quite difficult one - even I had to pause to stroke my stupendous beard in deep thought on occasion. Your problem, Terrance, stems from not being thorough enough in your investigations. In the room where you found the access card, there's a picture on the wall. Examine it closely and you'll find a piece of paper. Sketched on the paper is a clue to the access code. If you need more specific help then, thinking of the buttons from top to bottom, press them as follows: 6-4-3-7-2-1-5.

## Commandos: Behind Enemy Lines

**?** I have been playing Commandos: Behind Enemy Lines, for about two weeks and I am stuck on level six. I have cleared out the bombed out mansion and the surrounding area, destroyed the truck, taken out the investigating guards and had the sniper take out the Nazi on the roof. I get into the place with all the tents, but every time I try to kill one of the guards either by using the decoy or by sneaking up from behind I am spotted in the process.

**Angus Busby  
Email**



**\*** Assuming the "place with all the tents" to be the camp near the level's finale, once your sniper eliminates the guard on the roof (as you say you have done), instruct him to crawl to the crate stack. From here you get a decent shot at another guard who has his eyes on the entrance to the camp. Drop him and you'll be able to get your team into the camp.

## Might & Magic VI

**?** I have three problems. Firstly, how do I decode the puzzle of the 15 Obelisks? I have the 15 clues but don't know how to use them. Secondly, where is the key to the treasure room in the sewers beneath Free Haven? Finally, in the foyer of the Hall of the Fire Lord is a door that does not budge. Is it possible to open it? If so, how?

**Kielmark Greenfield  
Email**

**\*** I can see you're a man who likes to keep himself busy, so I'll waste no more time! The solution for the Obelisk conundrum of which you speak can be found in the northeastern region of Dragonsands. It is a rock in the centre of a stone circle that you seek. To the Free Haven sewers now, enter them via Sergio Carrington's house and approach the sewer grate near this entrance. Searching the area will reveal some gold and, importantly, a key. This key unlocks a door at the northern end of the sewers which may provide some assistance. And quickly to the Hall of the Fire Lord, you need the key from the Fallen Defender, whose corpse can be found at the bottom of one of the pits to the east. This key enables you to unlock a chest located in the north. Inside is a crystal skull that has the capacity to "unward" doors.

## Riven

**?** I've solved just about everything I can. I've powered up the Firedomes from the puzzle atop the Great Golden dome, but I can't get to Ghen's world. I know that the codes differ on each game, but can you tell



me at least how to find out the code to opening the dome and getting the linking book?

**Scozo**  
**WA**

\* I guess when you're as wise as I am, you tend to take small things like foreknowledge for granted. I sometimes forget what it must be like to be merely human and possess only a limited understanding of what the future may hold. Anticipation is the key to this puzzle. In the vicinity of each dome is what you might term a "dome viewer". To open the dome, you need to press the button on the viewer in the exact moment before the appropriate dome's colour symbol appears. Once inside, co-ordinate the five sliders to match the numbers in Ghen's journal then push the button.

### Thief: The Dark Project

? Well, it's finally come to this. After three years of reading your mag and laughing at all the hapless fools who can't work things out for themselves, now I'm forced to grovel on hand and knees to the great Oracle. What has become of me? For the life of me I just can't seem to find some incriminating information on Constantine. I have found a key in the back garden on the ground which doesn't seem to open any of the doors. I have also managed (it wasn't easy) to knock out all of the guards on every floor and have got the sword.

**Michael Komorowski**  
**Email**

\* Fret not, Michael, for though art only human. While the mortal try in vain to resist temptation, you have done well to defy it for so long. I shall endeavour to make the descent as easy for you as I can. In Constantine's garden, there is a staircase leading down from one of the greenhouses (identifiable by the row of potting benches). Follow it through the door and along to a room with a table upon which lies

Rakel's Tome of Magic. Under this table you will find a parchment that reveals some very interesting information about Constantine's financial dealings. Though, of course, I myself did wonder why Garrett's suspicion wasn't aroused by the fact Constantine has a hoof where his foot should be, but never mind.

### Knights & Merchants

? I've been playing Knights & Merchants and I need help. I'm stuck on level six, where I'm allied with the yellow pikemen. I've tried it over and over, but I keep getting defeated. What can I do?

**Martin van der Koogh**  
**Email**

\* Specific tips for any mission are tricky as there are too many variables to consider. Instead I can impart some valuable advice to enhance your leadership capacity. Firstly, speed is of the essence; whenever you feel as if you've constructed an efficient town layout, start the mission again and do it even quicker. Use your early attempts at a mission to scout out the entire map, so you know in which directions to expand your territory and where the enemy will first appear. Your construction routine should follow a similar pattern each time. Begin with a storehouse, schoolhouse and tavern, then proceed through quarry, woodcutter, sawmill, and grain farm. Now to cater for your military, build a barracks (away from the centre of town and close to where the enemy is likely to attack) then some pig farms, butcher, tannery, armoury and some weaponsmiths. The key to success is to only build what you absolutely need - don't waste resources on new buildings if the old



Thief: The Dark Project

ones aren't at maximum capacity. Remember that one tertiary industry services multiple secondary industries, which in turn service multiple primary industries. The logistics of war are measured in seconds, not metres - so make haste!

### The X-Files

? I'm stuck in The X Files! I have questioned James Wong on the dock, then gone back in to the warehouse to ask Skinner about the evidence I've found. When does Skinner mention the black car? When I return to the car to go to the crime lab, there is no car anywhere. Therefore I get stuck when I get back to my office. Do I need to ask the questions and find the evidence in a particular order first? In a certain amount of time? A bit of a walk-thru would be great!

**D. McMahon**  
**Email**

\* Over the ages, you mortals have developed intuition as way of compensating for your lack of omniscience. A good FBI agent should learn to trust his/her intuition, as you must do in this instance. Your hunch was correct, you do indeed need to ask the question and find the evidence in a particular order. At the warehouse, use your lockpick on the padlock where Skinner is waiting. Collect the follow clues with your evidence kit: blood stain on floor, bullet in post, butt on floor, and the crates near the door. Now go upstairs to the dark room and use your torch to find the crowbar. Return to the crates and jimmy them open with the crowbar. Again, collect with your evidence kit. Now head out the back door to the boat and talk to the guy there. Show him your badge if he needs encouragement. Remember, like Mulder does, to trust your instincts.

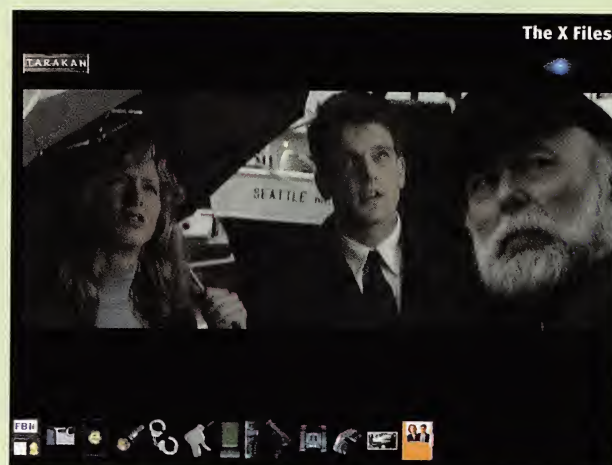

The X Files

# TIPS & TACTICS

Those little things the manual doesn't tell you...

## Star Wars: The Phantom Menace

★ Early on, the most important skill to learn is the double jump. Jump, and then hit the jump key again while in mid-air to somersault for greater distance. There are times when a running double jump is the only way to get from one platform to the next.

★ You'll find many situations in which you need to swing your way through a cluster of battle droids. The lightsabre is the best weapon here, especially when used in tandem with your Force push power. Avoid being caught in a crossfire, and keep swinging your sabre at incoming shots—you'll block most and send a few ricocheting back to the droids. Use the Force push to throw back some droids if you find yourself becoming overwhelmed by the rust buckets.

★ The destroyer droids can be very dangerous. If at all possible, run away to avoid them (bear in mind you may not always be able to do so). You can generally hear them coming, so get ready and see if you can get in a shot (with a ranged weapon) before they flare up their shields. Once their shields are up, use your roll move to avoid their fire (or at least as much of it as you can), and try to blast them with the most powerful weapon you have.

## Star Trek: Birth of the Federation

★ Expand first, fight later. Don't dump a lot of credits into your navy until you have contacted at least two races. Build your infrastructure first.

★ Dilithium is a key material. Fight hard for any system that contains it.

★ Shipyards extend your reach. A vessel's range is calculated from the nearest shipyard. So build shipyards on the outlying planets in order to explore/conquer further.

## Star Wars: Episode One Racer

★ As soon as you can, invest in a full complement of pit droids; this will ultimately save you the money you would spend replacing the worn-out parts that reduce your pod's performance.

★ Save your in-race repairs for twisting areas or hairpin turns where you have to slow down anyway.



★ For big money (and impossible odds), jump ahead to the Invitational races as soon as they become available.

## Tales of the Sword Coast

★ If you click on a loot item in a chest or on the ground, and you see it flash rapidly, do not click on it a second time; instead immediately click on something else on the screen. Some players have reported a bug that causes items to disappear this way, and it's an annoying way to lose a suit of plate armor.

★ It's useful to buy potions of Perception for your thief, and for good measure, you should also have someone casting Find Traps when you're in Durlag's Tower. The traps there are plentiful, hideous, and more often than not extremely lethal.

★ If your battles with the werewolves are going poorly, you may want to concentrate on magical attacks. Try to weaken them with as much magical damage as possible per round until you finally kill them.

## Imperialism 2

★ In general, don't bother trying to win over the New World with money or diplomacy. Instead, go the politically incorrect route and send in the troops to grab as much territory as possible before the other great powers can. Exploit the natives!

★ As soon as you develop rifle technology, turn away from producing expensive cannons and instead concentrate on infantry. Ten infantry units can take out a fort as quickly as the cannons, and they're also a lot cheaper to produce.



★ Be careful when it comes to playing power politics. The aim of the game is to conquer half of Europe, but do not let others benefit from your work. Computer players are more than willing to scoop up major powers that you have softened up or cut off from the riches of the New World. Concentrate on weakening the major powers one at a time.

## Mechwarrior 3

★ Don't think that an assault mech automatically means you are invincible. Even the heaviest mech can have its legs or chest torn out by a couple of well-placed shots. Keep moving and use cover.

★ Heat is something to monitor carefully. When you modify your loadouts, don't add more energy weapons than you can cool effectively. Those machine guns don't look like much, but they can keep tearing at an enemy while you cool down from that laser volley you just fired.

★ When battling enemy heavy mechs, send in whatever lance mates you have first while you concentrate heavy fire on the enemy mech's legs. Use the zoom feature for those accurate long-range attacks.

## Official Formula 1 Racing

★ Wheel spinning is a problem at the start of any race. To minimize it, don't let the revs exceed 10,000 RPM when the red lights go out, and don't feed on full power until your speed is more than 60 miles per hour.

★ Don't accelerate after you spin or slide off the track, it'll only make things worse. Be patient and get the car rolling by using only idle-level RPMs.

★ Select the softer compound tyres (D2 for dry weather, W3 for wet weather) for all races. The wear factor is so minimal that, even in a full-distance race, the tyres will probably last at least until the halfway mark.

★ Although the garage menu offers some user-friendly car adjustments to experiment with, you don't always need to use it. At many of the tracks, you can generally snatch pole position with the default setups.



# CODE

Impatient? Crap? Spineless? Do we have some cheats for you!

## South Park

Press Esc during the game and select Options. Then click in the lower left corner and enter one of the following codes to activate the corresponding cheat.

**EGOTRIP** - big heads

**BEEFCAKE** - invincibility

**SWEET** - unlimited ammo

**FRAMERATE** - displays frame rate

## Midtown Madness

To unlock all cars:

1. Right-click on the Start icon on the Windows task bar.
2. Click on Open.
3. Find the Midtown Madness icon and right-click on it.
4. Click on Properties.
5. Add the switch "-allcars" to the end of the field that says Target or Cmd\_line. For example, change the line to read:  
C:\Games\Midtown Madness\midtown.exe -allcars.

## Unreal

Type **ORDILOGICUS** at the game's title screen. The screen will flash if the cheat becomes activated. This cheat will give you invincibility and enable you to skip levels using the Enter key.

**ALLAMMO** - 999 ammo

**FLY** - flight

**GHOST** - walk through walls

**WALK** - return to walk mode if flying or ghosting

**GOD** - invulnerability

**SUMMON X** - where X is name of unit, weapon, or item; adds that unit, weapon, or item to world (for example, SUMMON NALI, SUMMON FLAKCANNON)

**PLAYERSONLY** - freezes time and starts time passage when typed again

**OPEN X** - where X is name of map, jumps to any map (for example, OPEN DIG)

**BEHINDVIEW 1** - changes game view to Tomb Raider style

**BEHINDVIEW 0** - resets view to normal

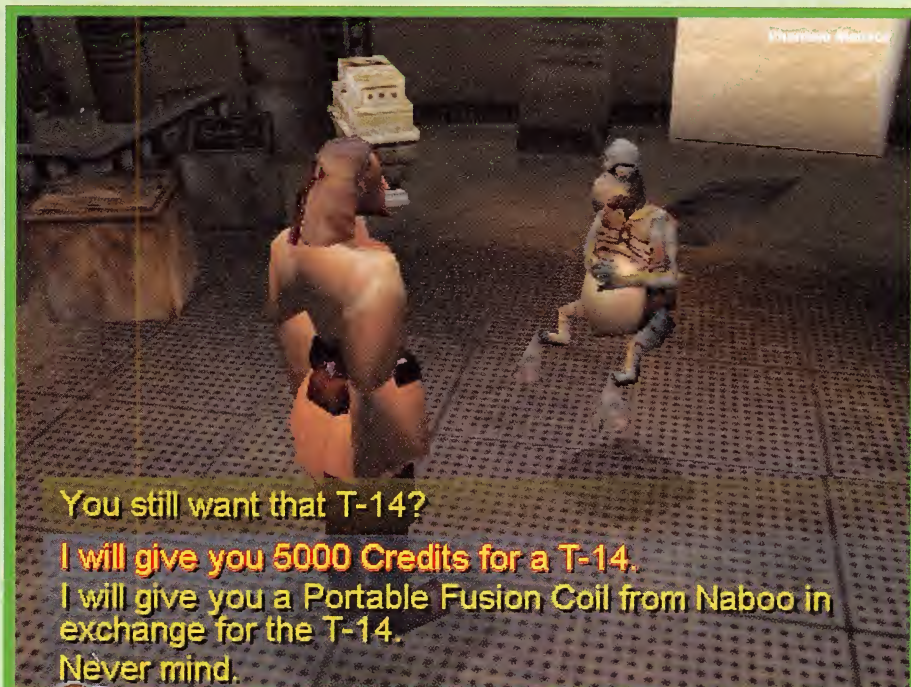

## Delta Force

While playing the game, press ` to display the console. Then type one of the following codes to activate the corresponding cheat function:

**iwill survive** - god mode

**closeto you** - invisibility

**takeitto the limit** - full ammo

**raindropskeep falling on my head** - allow call for Arty

**hit me with your best shot** - expert CPU

**big gulp** - refuel

**chiliburger** - heal

## GTA London 1969

**flashmotor** - level select

**iamfilth** - unlimited lives

**travelcard** - level select and unlimited lives

**iamgod** - 10x multiplier, unlimited lives, press

\* for all weapons

**averyrichman** - 99999999 points

**rommel** - debug mode

## Star Wars: The Phantom Menace

While playing the game, press the Backspace key and type the following codes:

**FROM ABOVE** - changes camera view to above player; typing again places camera directly behind player

**NAUGHTY NAUGHTY** - places camera directly behind player; typing again returns camera to normal

**I LIKE TO CHEAT** - gives all weapons and adds 500 shots to Weapon 2, 500 to Weapon 3, 5 to Weapon 4, 1 to Weapon 5, and 10 to Weapon 6

**GIVE ME LIFE** - sets health to 100 (even if already set higher)

**HEAL IT UP** - sets health to 100 (even if already set higher)

**IAMQUEEN** - play as Queen Amidala

**IAMPANAKA** - play as Captain Panaka

**IAMQUIGON** - play as Qui-Gon Jinn

**IAMOBI** - play as Obi-Wan Kenobi

## Star Trek: Birth of the Federation

Start the game with the "**-Mudd**" command line parameter to enable cheat mode. Then while playing a game, press one of the following keys to activate the corresponding cheat function:

**[F9]** - 100% research points distributed between current projects

**[F10]** - 10,000 additional credits

**[F11]** - Full map



## Jimmy White's Cueball 2

Wander around the snooker room and look behind the grandfather clock to find the mouse hole on the floor. To enter, click on a bobbin of thread in the hole. A sign will appear saying "Cheat Enabled". After leaving the hole, all players (including Jimmy White) will be accessible in the snooker and pool rosters.



By Rod "Spoonman" Campbell

**T**ribes is a very different game to most FPS action games currently doing the rounds. The idea of actually buying your weapons before you go on a journey makes for a much more even struggle and the people who camp around the rocket launcher don't always win, and probably won't last very long at all. With quite a few foreign concepts in one game we have devised this playguide to not only introduce new players to the world of Tribes, but to also give experienced players an edge over the enemy.

### THE BASICS

If you want to survive playing Tribes on the Net or at LAN Parties there are certain things you need to know. Without at least basic knowledge of what you can and can't do you're going to meet your maker in a matter of seconds. Here is a list of some of the things you should have a good grasp of before you enter into any battle.

#### Buying weapons the easy way

This is an extremely important part of the game, but many people do not use the service as efficiently as possible. While in a training mission work out what your best weapons are (the ones you like the most). In the safety of the Training Mission (with no one to shoot you) click on the "Mark Favourites" button and choose which weapons you use most often. This way when in a real battle all you need to do is go to an Inventory Station (I.S.) and click on "Buy favourites" - this gets you all the things you want in a split second and you don't have to cycle around finding what you need. Every second is vital in Tribes and you can save several here.

#### Power and keeping it on

Power is the Tribes lifeline, without it, your Tribe is ripe for the picking. Some bases

have no power sources, some have one powering everything, while others still have several - each powering different things. You as a player need to know which one does what. Obviously if there is only one it needs to be guarded accordingly. If there are several you need to list them in priority and then work out which defences to use. It's no use defending almost all of your generators with turrets when it happens to be the one you haven't defended which powers the turrets. Make no bones about it - the enemy will know this, so you must know it too. If you find a piece of equipment which is destroyed or informs you "Unit not powered", someone has to go and repair it. Report this to your commander and they will take (hopefully) corrective action. If

you happen to have a repair kit on you simply press the key bound to "use Pack" (generally "p") and fire it at the object.

#### The jet pack

Using the jet pack well is a certain way to helping achieve victory. Any player who can actually think in three dimensions rather than two will know an attack can come from any direction at any time, even the air. Using the jet pack proficiently is as important for defenders as it is for attackers - if they can meet them in their air they're got more of a chance for survival. When using the jet pack, jump before you fire it. You'll get much better height that way.



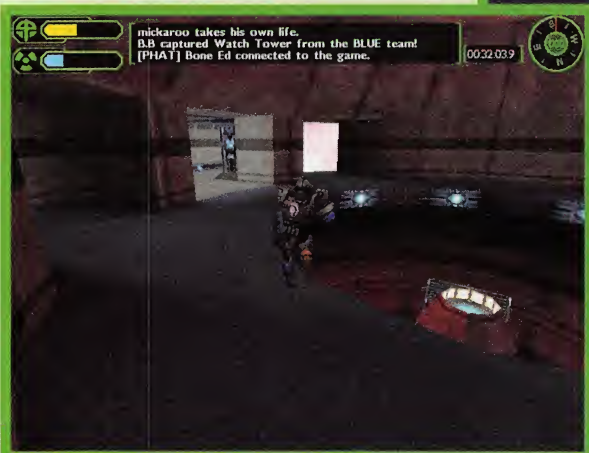
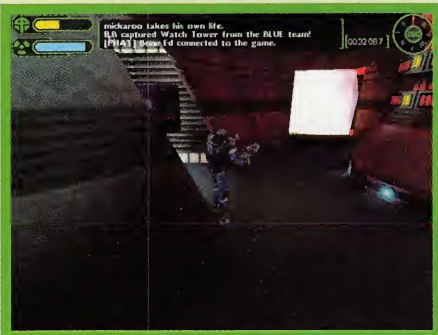

## Teamwork

Teamwork is the number one most important aspect of Tribes. A team of mediocre players will always beat a group of lone deathmatch players. The first thing you need to know about Teams is the buddy list. In the server menu where you start the game is a spot where you can type who your friends are. This is great for clans because if you type in a certain string, the server will make buddies of all the people with that string in their name. E.g. if I am Spoonman [NGL] and everyone else in my clan has the [NGL] extension, then I only need to type [NGL] into the buddy list and they'll all come up.

Much of the teamwork happens before the game. If you're playing on a LAN it's very easy to simply have a chat to the other players and work out who is doing what during the game. Naturally, it's a little more difficult online but still possible with the chat features. This is important because at the start of a game Tribes are most vulnerable - they haven't built any Turrets yet and they are very ripe for the picking. This goes double if they don't know who's playing what position right from the outset. Sort it out early and remain in control.

During the game the Commander coordinates almost all teamwork. They should be selected very carefully - intelligence, quick reflexes and an intimate knowledge of Tribes' mechanics should be high on the priority list. Once the Commander has the trust and support of the Tribe, you've mastered the hardest part of Tribes.

The Commander needs to know who is doing what, which skills each player is good at, and coordinate accordingly. Each Tribe member should obey their instructions to the best of their ability, even if they think that they will fail. If they think the mission is impossible, they should tell the commander, but then continue on until told otherwise. A

silent commander is a bad commander. All commanders should learn to use the generic

messages to good effect - it saves a lot of typing and also means the Tribesmen don't need to stop to read something. Tribes is a very fast game, the Commander needs to be on their toes at all times, and need to report any movement to their players and be able to get firepower in the right position early, that's what makes a good commander. A communicator.

## PLAYER CLASSES

Although you can fit yourself out with whatever weapons and armour you want there is little use in a jack of all trades and master of none character in Tribes. Anyone with a specific purpose will be much more effective in battle than you are. Pick a role and stick with it. Either that or change your weapons and armour before changing your duty.

We have listed several key player classes useful in almost any situation, which you can use as templates. Of course you can change any of the attributes to suit more your playing style.

## COMMANDER

The commander is ultimately responsible for the way the Tribe operates as a team, you can have some of the best players available and still lose miserably because the commander didn't know what was going on. The Tribe's commander needs to above all have trust in the Tribe members, and be able to foresee events happening before they eventuate. This way they'll be able to direct firepower in the right direction before it's needed, meaning the fighting force will be much more effective. The commander binds the various Tribe members into a team, and without teamwork a Tribe is useless.





### WEAPONS PLATFORM

**Main Weapon:** Mortar  
**Secondary Weapon:** Disc Launcher  
**Armour:** Heavy  
**Other:** Ammo Pack

The big guy, he doesn't move too fast and he needs plenty of support, never the less, once in his element the sheer power of the Weapons Platform guy is a necessity for any Tribe.

### DEFENDER

**Main Weapon:** Disc Launcher  
**Secondary Weapon:** Chaingun  
**Armour:** Medium  
**Other:** Shield Pack

Every base needs defenders, the ideal defender is relatively fast but can also destroy infiltrations quickly, and turrets will help for that. Defenders don't usually need to use their jetpacks often so their armour can be a little heavier than that of an attacker. Either way defenders need to communicate with each other to keep a tight ship, a base with defence on only one side is not hard to infiltrate.

### GENERAL WARRIOR

**Main Weapon:** Disc Launcher  
**Secondary Weapon:** PlasmaGun  
**Armour:** Light or Medium  
**Other:** Energy Pack

This is probably the closest you'll get to a jack of all trades. This player's main job is to harass the enemy mid field and try to ensure they don't reach their target. This player needs to be very adept at using the Jetpack because it will make them a much more menacing force. A light armoured player who is good at using the Jetpack will be much more dangerous than a medium player who isn't.

### ENGINEER

**Main Weapon:** Disc Launcher  
**Secondary Weapon:** PlasmaGun  
**Armour:** Medium  
**Other:** Repair Pack

This player's characteristics are almost

exactly the same as a Defender, mainly because they'll be called to defend when they're not repairing things. An Engineer will be called to repair almost all base facilities from time to time from turrets, ammo stations to sensors.

### GUNNER

**Main Weapon:** Turrets  
**Secondary Weapon:** N/A  
**Armour:** N/A  
**Other:** N/A

Almost any type of player can fill this role. Turrets are generally much more effective when manned, the Gunner (when told to) uses the Command Console to fire turrets at attackers.

### MEDIC

**Main Weapon:** Disc Launcher  
**Secondary Weapon:** PlasmaGun



**Armour:** Medium  
**Other:** Repair Kit

A mostly forgotten role, but one which can certainly make the difference in a long sustained battle. The aim of this player is to run around during battles and heal whoever is sick. When there is a lull in the fighting they should go back to base and help the engineers with base repairs.

### SPOTTER

**Main Weapon:** Disc Launcher  
**Secondary Weapon:** Laser Targeting Device  
**Armour:** Light  
**Other:** Energy Pack

Probably more of a sub role than anything else. These are used to "paint" targets for the weapons platform players to shoot at. It makes sense for the "painters" to be the weapons platform support team, so they should stick around that player at all times and ward off any intruders.

### SNIPER

**Main Weapon:** Laser Rifle  
**Secondary Weapon:** Disc Launcher  
**Armour:** Light  
**Other:** Energy Pack and Laser Targeting Device

Like the general warrior the sniper is best for keeping the enemy off guard and putting them in two minds as to where they should attack from. If the enemy doesn't know whether a route is safe from sniper fire or not then the sniper has done a good job. If



## Tribes on the web:

The official Tribes Website is located at:

<http://www.tribesplayers.com>

This site contains all the latest news and patches, not to mention the Official Tribes List and extensive trouble shooting guide.

Otherwise you can always swing by:

<http://www.planet-tribes.com>

Which is a community site with loads of tips and tricks for the uninitiated, as well as many forums and other community aspects.

Without anything to lure the enemy into a trap, your ambush party may be sitting around staring at bugger all for extended periods of time. Because of this you have to either make something enticing or use something already in place. You can use anything from natural objectives such as bases or flags. A lone wounded soldier or some sup-



they are not sure they'll probably choose a less direct route to the base which will give your team more time to react and get good defences in position early.

### SUICIDE BOMBER

**Main Weapon:** Disc Launcher

**Secondary Weapon:** Chaingun

**Armour:** Medium

**Other:** Shield Pack

Get in, destroy as much as you can, try and get out. The shield pack makes life much easier for this Saboteur, since it effectively doubles its life expectancy. Saboteurs though expect to die on their missions so don't be too worried about taking out enemy Tribesmen, simply go for the base.

### PILOT

(Only applicable on maps with Vehicle Pads)

The weapon load of the pilot makes no difference to their job but their flight skills certainly do. A good pilot must know the terrain intimately and be able to put assault teams in position first time every time. Flying a plane with the mouse just doesn't feel right, especially if you don't invert the Y-Axis. If you think one player is going to spend almost all the time flying one craft or another it is definitely worth them using a joystick. Even if they have less control on the ground they'll be unstoppable in the air.

### ADVANCED TRIBES TACTICS

There is a fine art to everything, including Tribes. Know how to make an effective ambush? Or maybe how to snipe with success? Read on.

### THE AMBUSH

An effective ambush requires four things:

1. Something to entice the enemy.
2. Timing
3. Exceptional player arrangement
4. Quick and efficient destruction.







If you keep these general ideas together and mix up your ambushes a bit you'll be able to surprise your enemy most every time, and while you're surprising them on one side your attackers are going for gold on the other.

### EFFECTIVE TURRET USAGE

Placing Turrets is an art worth your learning. Effective Turret placement is a sure fire way to put some serious dents in the enemy and discourage further attacks until they've re-grouped. Turrets can't shoot that far, thus



you need to put them in a place where they can't be destroyed from a long distance. Put them in places where they can only be destroyed from a position within their range. Placing them around corners is good, but putting them in corridors can make them easy prey from grenades.

Turrets though aren't much good if they're blown apart, and there are several strategies against this tragic course of events. Firstly place turrets away from walls. There are a lot of weapons in Tribes which feature at least some splash damage, so having your turrets right next to walls will have them falling much more easily. Secondly you should always place turrets in pairs, and make sure that if you're out of the line of sight of one you can still be seen by the other. Thirdly move your turrets around. Once players get to know where your turrets are they'll just lob some grenades around the corner and take them out before advancing. If you rotate them between different positions the enemy players will get paranoid and start firing grenades around every corner, which wastes a lot of time and ammo for them.

The last thing you need to know about Turrets is that they will deteriorate to a point of uselessness. So your engineers have to keep patrolling the defensive line and repair when necessary, it might even be quicker to destroy a damaged turret and then replace it than repair it. Remember turrets do not function at under 40% health. Attackers may leave them in this state to fool defenders into thinking they're still operational when they aren't. A winning tactic we assure you.

### SNIPING FOR SUCCESS

A sniper who doesn't do their job is a mostly useless player. Anyone who ever liked camping in Quake will not make a good sniper unless they understand why they're doing this job. The job is not to keep people away from the big weapons but to harass the enemy and to keep them guessing about who is where. A good sniper will also recognise that stealth is the key to success.

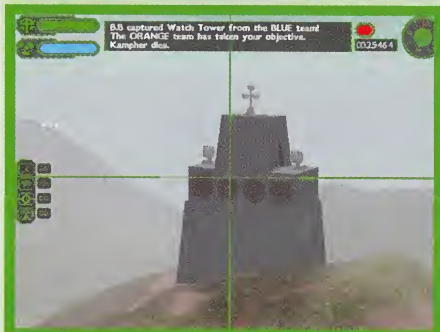

Every time a sniper kills someone they're closer to being found and annihilated. Because of this a sniper must choose their targets very carefully. Firstly - if you aren't absolutely sure you can hit it and at least damage it severely, don't shoot it. Try not to shoot people facing your direction because they can come back and have a general idea about your hiding place. Always try and shoot lone targets, if other people see you shoot them they also know generally where you are and will hunt you down. Attacking base assets as a sniper might seem like a good idea but once again do it when no one is watching. We can't stress enough that being a sniper requires you to be as stealthy as possible. If you aren't seen and people wonder what hit them when they respawn for the twentieth time you're doing a good job. If you die at all while in your sniping position, you have failed.

### ENGINEERING: THE BASE OF ALL VICTORIES

Primarily, it's the engineer that looks after base defences and repairs. This is more tricky than it seems and involves a lot more than just mopping up after an invasion. The first priority of any engineer is to place a number of alternate Inventory Stations in and around the base, as this frees up the main station for asset deployment.

Once that is done they need to start building turrets in and around base facilities with the assistance of some defenders. Turrets are the main item for deployment - once they're out sensors and jammers should follow. Once you have placed all your turrets it is about time to be assessing the damage from any early raids. As the main engineer you should work out a loop and keep going around that looking for repair work unless anything abnormal happens. As the general defender you should look out for anything which isn't working properly and either fix it yourself if you have time or let the head engineer know. In lulls in the battle go around to each of the assets in your area and check if they're still operational. If they aren't make some corrective measures.

# The Weapons

Tribes' arsenal features a hi-tech collection of no-nonsense weapons of destruction. Learn how to use each to their best effects.

*NB: Gravity Effect is whether or not the projectile gets drawn toward the ground or not after firing.*

## BLASTER

**Projectile Velocity** - 200 m/s  
**Damage** - 12.5  
**Range** - 400m  
**Gravity Effect** - No

The blaster feeds off your armour's energy, so even though it uses no ammo you'd be mad to use it in a full on combat situation. This is because the more you fire, the easier you are to kill. It's poor against enemy assets because after 200m the damage done against shielded objects is drastically reduced. It's only really good taking out people who are standing still. Use only as a last resort or sniping.

## CHAINGUN

**Projectile Velocity** - 425 m/s  
**Damage** - 11  
**Spin-up time** - 0.5 Seconds  
**Spin-Down time** - 3 seconds  
**Range** - 640m  
**Gravity Effect** - Yes

This is the fastest firing weapon in the game and excellent for taking out enemy assets, though accuracy is its greatest downfall. It's deadly when fired as a group. Ground targets are preferred over air targets with this one.

## DISC LAUNCHER:

**Projectile Velocity** - 80 m/s  
**Explosion radius** - 7.5 m  
**Damage** - 80  
**Spin-up time** - .25s  
**Range** - 520m

The replacement Rocket Launcher will probably be in just about everyone's arsenal for one good reason - when it hits, it hurts. Unfortunately, due to its slow firing rate it isn't very good against shielded assets, as the shield will recharge before you can get another shot in. It is however the number one Player to Player weapon, especially due to its splash damage. You only have to hit them once.

## GRENADE LAUNCHER

**Projectile Velocity** - N/A  
**Explosion Radius** - 15  
**Damage** - 40  
**Range** - 150m  
**Gravity Effect** - Yes

A fairly stock standard item which is far more useful with lots of practise. It's better suited to light and medium players so they can combat heavy mortars. It's quite good for bombarding the base as well. Just be aware that unlike the grenades you're used to (in other FPS action shooters), Tribes grenades bounce a lot more which makes them quite dangerous to be firing in enclosed spaces.

## MORTAR

**Projectile Velocity** - N/A  
**Explosion Radius** - 20

**Damage** - 100  
**Range** - 250 m  
**Gravity Effect** - Yes

The main weapon to use if you actually want to destroy something. Mortars are fantastic against shielded items and players alike. Hitting almost any player with one will send the gibs flying. The drawback of course is that anyone carrying one will be so slow that they will be picked off by almost any other player if they aren't protected. The mortar works best when teamwork is at a maximum.

## PLASMA GUN

**Projectile Velocity** - 55 m/s  
**Damage** - 45  
**Explosion Radius** - 4  
**Range** - 165m  
**Gravity Effect**: No

This weapon has two main strengths - against light armoured players and the enemy base. Its fast rate of fire makes it ideal for light players, so you should be able to kill them in three or four shots. The rate of fire is also useful against base assets and it also has some small splash damage. It's much less useful though against other players - switch to the disc launcher instead.

## LASER RIFLE

**Muzzle Velocity** - N/A  
**Damage** - Depends on Energy.  
**Range** - As far as you can see.  
**Gravity Effect** - No.

This weapon is basically the sniper version of the Blaster. It can only be carried by light armoured players with an energy pack so the sniper needs to be protected from short range attacks (again teamwork). The laser will do proportional damage depending on how much energy you have, with full energy you can just about kill a light player. Do not hold down the trigger of the gun, all it does is waste energy, your shots will do less and less damage the longer you hold it down.

## ELECTRON FLUX GUN

**Projectile Velocity** - N/A  
**Damage** N/A  
**Range**: As far as you can see  
**Gravity Effect**: No

The ELF gun may not damage objects, but it sure makes the job easier for other people. Its one purpose is to suck energy, and energy is life in Tribes. Point it at a shielded base asset and watch with glee as your team mates waste it with no effort whatsoever. There is also a secondary use for the ELF Gun. You can drain energy off players meaning they can't use their Jet Pack, which makes them much easier prey. After all the energy is gone the ELF Gun will deal some damage but it's nothing to write home about.





S H A R P E R I M A G E S



S U P E R S O N I C S P E E D



S E X I E R G A M E P L A Y



**MAXI GAMER PHOENIX2**- 8 mb card integrating the Riva TNT Vanta chipset from Nvidia™ • True colour 32-bit 3D rendering • AGP 2X interface with full side-band support • Open GL® and Direct3D®/ DirectX® hardware accelerator • TwiN Texel® architecture with 32-bit (16 million colours) rendering • 2D Engine with display resolution up to 1920x1080 in 16.7 million colours • DVD options - Optimised for full-motion video playback acceleration for Microsoft DirectShow®, MPEG-1 and MPEG-2.



**MAXI GAMER XENTOR** - 16MB super fast 166MHz RAM With Riva TNT 2™, Nvidia's latest generation of 3D graphics processors generating up to 9 million triangles/sec • 270 million texture-mapped pixels/sec • Full true 32-bit 3D rendering • AGP 2X interface with full texture transfer support • Open GL® and Direct 3D®/ DirectX® hardware accelerator • TwiN Texel™ architecture with 32 bit (16 million colours) rendering enabling • Outstanding resolutions up to 1920x1440 in 16,7 million colours and 2048x1536 in 65 000 colours performed with a 300MHz RAMDAC + Xing DVD® player • DVD Video playback optimisation with hardware support and video acceleration



**MAXI GAMER XENTOR 32** - ADDED FEATURES OF THE XENTOR 32. 128-bit RIVA TNT2™ ULTRA chipset generating 9 million triangles/second • 32mb Ultra fast 183MHz RAM to tackle texture-intensive games • Outstanding resolutions up to 1920x1440 in 16 million colours • Extra TV- Out for excellent image playback of DVD titles or games on your TV.

[www.guillemot.com](http://www.guillemot.com)



Maxi Gamer Xentor™, Xentor 32™, Phoenix 2™ and Guillemot™ are trademarks of Guillemot Corporation. All rights reserved. NVIDIA, the NVIDIA logo and RIVA TNT2, RIVA TNT2 ULTRA and TNT VANTA are trademarks of NVIDIA Corporation. RIVA is a trademark of NVIDIA Corporation and STMicroelectronics. All trade names referenced are the trademarks or registered trademarks of their respective holders. Photos not binding. Contents, designs and specifications are subject to change without prior notice and may vary in different countries. Guillemot Corporation is represented in Australia by Ubi Soft Entertainment PTY LTD: PO Box 43, Edgecliff, NSW, 2027. Tel (61 2) 9362 1414.

**Trade enquiries- Acclaim Entertainment- (61 3) 9681 6300.**

# HEROES OF MIGHT & MAGIC III



## PLAYGUIDE

Being a hero of both might *and* magic requires an intimate knowledge of your forces, and a firm grasp of a winning strategy. Singe Graham talks HOMM3.

### OVERVIEW

The depth and variety of the different units, spells, races and play styles of Heroes 3 can be rather intimidating and confusing. Put those feelings of inadequacy aside as you absorb the knowledge contained herein. Mastery of HOMM3 can be achieved only through practice. The strategies given here work well against the computer, and, used wisely and correctly can help to defeat other human players as well.

This guide will firstly start with an overview of standard play-styles for all races then focus on each one specifically to give you a little more insight into your chosen power.

Here are a few of the basic rules:

### NEVER LEAVE A CITY UNDEFENDED

Whilst it may be tempting to send out all your heroes and all your troops on a rampage, we've lost count of the number of times we've seen people send a large

squadron of all their troops to attack one defended city - only to find that an enemy hero has just calmly walked around them and taken their city. This leaves you with a large squadron of units, but no income and no troop production. Needless to say, this is a bad thing. Even if you've only a few archers and a hero left to defend the city, if you have a castle then the turrets will at least deliver a bit of a spanking to their force, and you can say you put up a fight too.

### SPELLS SPELLS SPELLS

You can never have enough spells although a lot of people tend to understate their value. Whilst upgrading to a level four mage guild is expensive the results are worth it. Think about it. Let's say you have an average hero with spell power of 4 and an equivalent knowledge of about 4 or 5. That means you're going to have about 40-50 spell points to play around with. Now a level 4 magic arrow does 50 points of damage for just 5 SP. A level 4 Ice Bolt does 90 points of damage for just 8 SP. That's 90 extra damage a round for 5 rounds, or 50 extra damage a round for 8 rounds. Never underestimate that amount. While it may not seem like much, a high level spellcaster hero with a power level of about 8 or 9 can CHEW through missile troops like there's no tomorrow. Which brings us to the next point...



You know once you've reached a point where you've got a little of everyone's level 7 troop types you're kickin' ass

### MISSILES MISSILES MISSILES

You should always have a LARGE number of ranged units in your groups. 50 Grand Elves or 50 Marksmen are more than a force to be reckoned with. If your group is comprised solely of 50 Grand Elves and 3 Gold Dragons you may be tempted to send your dragons into the fray to mix it up with them directly. Bad idea. 3 gold dragons may SOUND intimidating, but the fact is that unless you've got a hero with a very high attack/defence skill they're just screamin' for a creamin'. As with any level 7 troop type for that matter. Hang the gold dragons back to protect the archers whilst they pick off the enemy as they make their way towards you. 3 Dragons or 3 Archangels or whatever you may have are MUCH better used as a clean up squad. Once the archers have slammed the group of units sufficiently, send in the heavy





Hmmm.... that artifact's around here somewhere...

**Mid game:** Make sure you have a plentiful supply of Swordsmen in your group backed up by lots of Marksmen and dotted with about 8-9 zealots. Griffins are a little bit iffy. Unlimited retaliations are nice, but the basic idea is you don't WANT your units to be attacked and need to counter. Griffins don't really have the stamina to take a lot of shots and make their unlimited counters useful. They're great for cleaning off weak units or to get close to Archers so they can't shoot, but they are NOT made for mixing it up with the enemy at all.

**End Game:** Archangels. Yes... big... nasty... meaty. Archangels I'd almost say were some of the best, if not the best, units in the game. Their speed is very high, they have plenty of HP and deal lots of damage. Of course their price tag isn't very appealing, but towards the end of the game what's a little 5k here and there? Cavaliers and Champions are another iffy unit. The cost of a jousting arena is quite high (in wood terms). And whilst they are fast they're two squares long, making it easier for enemy units to crowd around and take them down. Take a few in your group (about 5 or 6), throw in a few Archangels, tons of Marksmen and Swordsmen and you've got yourself a lethal combination.

#### RAMPART (ELVES):

**Early Game:** Get yourself a Wood Elf homestead and some Elves. If you start with a Dwarf cottage then don't upgrade it just yet. As with the humans and their Archers, you want to upgrade to Grand Elves as fast as you can. Grand Elves are slightly tougher and do



no way they can take any. A level 7 unit usual has an average of about 200 HP which all are recovered at the end of battle. So if an Archangel takes 249 points of damage, it's still alive and healthy again next round. If a pack of troglodytes take 249 damage you've just lost 49 troglodytes with a really sick 50th. Try not to place low level units in situations where they can be countered to the extent of losing half your troops at once.

#### TROOPS FIRST, STRUCTURES LATER

A lot of people will tend to go for an upgrade frenzy without noticing the enemy hero with a moderate amount of troops slowly approaching your poorly defended city. As a general rule of thumb, upgrade your first three unit types quickly, gather a respectable force to consolidate, then work out building and upgrading other troop types. Otherwise you've just given your enemy a free city with lots of juicy upgrades. Damn.

#### RACE SPECIFIC TACTICS:

##### CASTLE (HUMAN):

**Early Game:** Archers and Marksmen are your best friends early on in the game. A good strategy is to try and upgrade your Archers to Marksmen ASAP, as a force with 10 Marksmen, about 20-30 Pikemen and maybe a few Swordsman can easily take out a pack of lesser monsters. Have your melee troops hang back while you shower the enemy with two volleys of arrows per round, then have the Pikemen and Swordsmen finish the enemy up close.

#### MORE IS BETTER

Ok, so level 1 units are cheap and weak. But they ARE plentiful. Most of the races level 1 troops produce at 30+ per week when fully upgraded (i.e. Castle + Birthing Pools/Captains Quarters etc.). While 35 troglodytes sound pissy, never discredit their value. Players tend to immediately disregard level 1 troops as being useless. Nothing could be further from the truth. Low level, cheap units banded with a hero with a high attack/defense strength are DANGEROUS. 150 troglodytes can do anywhere from 150-450 damage (base) per attack. Couple this with the attack skills of a decent Knight or Barbarian hero and you've got some serious damage dealing capability. You must watch counter-attacks though. Hordes of low level units can really dish out the damage, but there's



Town Halls and all money making structures are good stuff. Always try and upgraded to a Town Hall or equivalent ASAP



An early start for a rampart player. After you've scouted initial areas without picking a fight, make sure to return for re-enforcements



more damage than Marksmen so the results are definitely worth it. Centaurs and Dwarves are going to need to be the base of your melee troops though neither are particularly strong. Dwarves aren't bad, but their speed restricts them to mainly a defensive role. Once you've upgraded them to Battle Dwarves they become a little more flexible, but defence should still be their primary role in any battle.

**Mid Game:** Complement your army with Dendroid Soldiers. Like Dwarves they're slow, but their entangling ability can be very useful against fast moving enemy fliers trying to attack your Archers. Make sure they hang back if the enemy has a fast mover because the chances are they'll go for your ranged units. When they do, hit them with the Dendroids and back your Elves away while you pick them off. Pegasi function a lot like Griffins, but again aren't very durable so try not to get them into the heat of the battle too much.

**End Game:** Dragons and Unicorns become your best friends. A Dragon's breath attack is able to reach 2 squares across in attack, so although you're able to hit two adjacent enemy units, be careful that you don't hit your own troop. 5 Gold Dragons breathing fire on your own group of Centaurs fries them pretty quickly. Gold Dragons also have the bittersweet ability of being immune to

1st-4th level spells. This of course means they can't be magic arrowed or frost bolted etc. It also means you can't bless or haste your Dragons. A good end game force should consist of a few Dragons and Unicorns, a pack of Dendroid Soldiers, plus lots of Grand Elves and Battle Dwarves with a few Pegasi to take out stragglers.

### TOWER (MAGES):

**Early Game:** Upgrade your workshop and any Gremlins you may have as soon as you can. Normal Gremlins can't shoot, however any upgraded Gremlins get 8 shots. It doesn't seem like a lot, but when you consider that it's the Mages level 1 unit and produces exorbitant amounts each week they become VERY dangerous. Gargoyles are again another flying clean up crew, however Golems can be used effectively against any spellcasters due to their 50% magic resistance. A large pack of anything is a viable target for a lightning bolt, but when 50 Golems are only going to take half damage the enemy will generally target something less important, leaving your large Golem crew to plough through the enemy like a hot knife through butter.

**Mid Game:** Arch Magi are definitely a worthwhile investment at this stage. No melee penalty coupled with a strong range attack at a reasonable cost per unit just can't be beat. On the down side though, their structures are quite expensive to build. Requiring a fair bit of all resources to construct. Genies and Nagas are in the same boat. Both are relatively powerful units but come at an outrageous cost to the player. At this stage however you shouldn't be TOO fussed about Genies and concentrate on building your Naga force. Genies are fast and powerful, but at this stage of the game having a strong unit that can't be countered is really a priority. Genies however are very useful when attacking castles. As they can simply fly over the castle walls, cast



haste on them and have them mug the largest group of missile units available. **End Game:** The upgraded cloud temple is bordering on one of the most expensive structures in the game. Titans however are more than worth it, with a whopping 300 HP each coupled with a powerful ranged weapon and NO melee penalty. To quote a saying; "These guys really rip the #@\*%". BE CAREFUL though. If an enemy sees a Titan in your pack they'll want to take it out like there's no tomorrow. Use Titans wisely as they're expensive and come with a big "Shoot me" sticker on them.

### INFERNO (DEMONS):

**Early Game:** Demons are one of the harder races to start out with. As the majority of their low level units have no distinct advantages a great deal more tactics is required to play. Try and upgrade your Gogs to Magogs as quick as you can. You're going to need all the firepower you can muster. Hellhounds are a worthwhile investment for very early stages, but you want to upgrade to Cerberus soon for their three headed attack and non-countering ability. Familiars certainly aren't the best unit to begin with. Their magic absorbing ability is novel but not terribly effective. Try and just tiptoe around the enemy to begin with until you can get some more power under your belt.

**Mid Game:** By now your forces should contain a good force of Magogs, Cerberus, Horned Demons and maybe a few Pit Fiends. Magogs should now be grouped with a hero with a solid attack power. Their fireball attack is great for taking out clumped groups of enemies. But as with all area effect attacks,



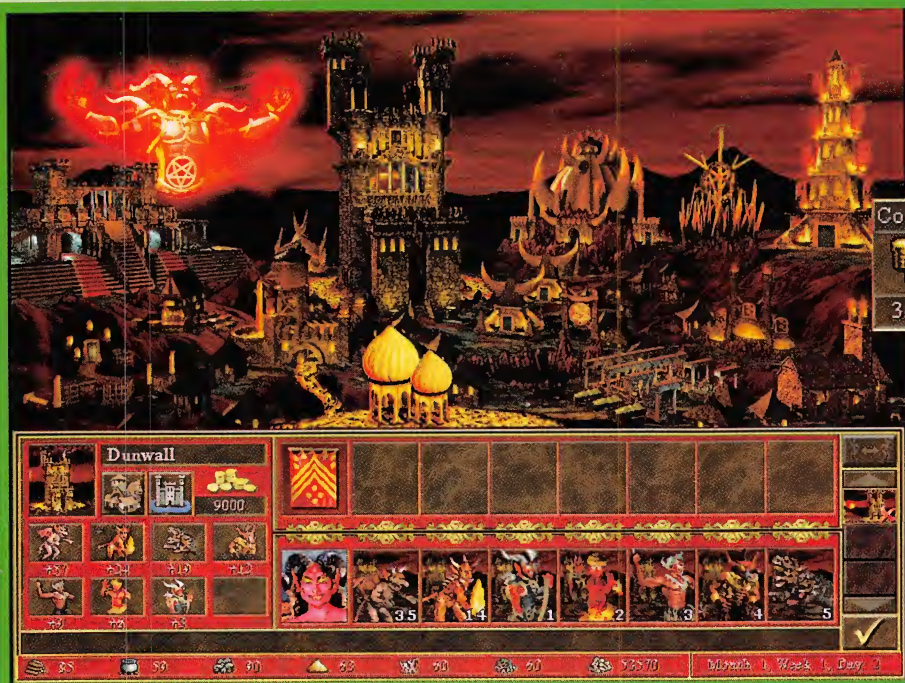

A fully upgraded Demoniatic Town...

make sure you don't hit your own guys! Horned Demons are your first real solid, damage dealing/receiving grunt troops. They take and dish out a reasonable pounding, but take care that you never get them isolated in battle else the enemy will take a big chunk out of them. A good strategy is to send a large pack of Cerberi into attack a cluster of enemies and back them up with a decent sized pack of Horned Demons. The Cerberi wound all the enemies without getting countered while the Demons come in to finish them off.

**End Game:** Arch Devils are a must. Their speed is unparalleled and their strength, coupled with their ability of not being countered, turns them into lethal, fast, killing machines. Be wary of their hit points though. They're susceptible to group attacks due to their low damage tolerance. Efreeti function in much the same way as Genies. Their fire shield ability is a nice touch but not terribly effective unless you've a large back of Efreet. You should have your Magogs soften the enemy up, your Horned Demons, Pit Fiends and Cerberi charge into the enemy to engage them, and have your Arch Devils be the silent death which deliver the power blows to the large groups of engaged enemies.

### NECROPOLIS (UNDEAD):

**Early Game:** Skeletons and Wights aplenty. Try and upgrade your Wights to Wraiths quickly. Wraiths are excellent against lower level monsters due to their regenerate ability. They move fast and can hold their ground against most of the lower level creatures very well. Skeletons are the basis of any undead army, however a group of less than 50 isn't terribly effective. Use your Skeletons to finish off any group that you know they can take out in one shot. Once you've got a reasonable sized group that you know can withstand a couple shots and still remain a solid force



then have them charge in to weaken the tougher enemies. But just be careful, you DON'T want to lose the main power hitters of your army and Skeletons DON'T have many hit points.

**Mid Game:** Vampires should either be used in huge quantities or not be used at all. Their vampiric ability that enables them to recover lost units is great, but unless you've got enough vampires to cause enough damage to regrow your lost units they're not worth the investment. Power Liches are the go at this stage. Their ranged weapon is very spanky indeed and doesn't affect any of your (or their) undead units. Death Knights are great close combat fighters but are a little on the slow side. The best tactic is to get a group of about 10 or so together and use them as support melee troops. Throwing them needlessly into battle is a good way to get them killed, but if they back up your forces of Skeletons and Zombies you should be fine.

**End Game:** Bone and Ghost Dragons should be bought and used at your discretion. Ghost Dragons are probably one of the weakest level 7 units in the game, dealing only 25-50 damage with 200hp, but are also one of the cheapest. Used wisely in conjunction with high level Death Ripple spells, you can take out a powerful enemy force in no time at all.



### DUNGEON (OVERLORDS):

**Early Game:** Try and upgrade to Evil Eyes as quickly as you can. Overlords suffer from an early shortage of solid ground troops and need powerful ranged troops to compensate. If you have a hero whose speciality is Troglodytes then all the better. If you can purchase a Troglodyte-inclined hero they should bring approximately 60-70 Troglodytes with them. Couple that with the base 14 that you begin, upgrade them, then purchase 7 Evil Eyes and you've got yourself a solid, base squad of guys, useful for clearing a path to a sawmill or an ore mine that's blocked.

**Mid Game:** At this stage you want to try and have a good force of Minotaurs in your group. As these are the Overlords first "real" grunt troops you'll want to produce them in great forces. They're strong, not overly priced and their good morale bonus enables them to be more likely to strike again in combat. Medusae are a matter of personal preference. As ranged troops they aren't terribly effective. When engaging in melee combat however, they have the most useful ability of being able to turn the enemy to stone for a few rounds. The chances of this happening appears to be related to the strength of the Medusae compared to the strength of the victim. In other words, don't try and attack an Arch Angel with one Medusa. On the whole you should generally try to AVOID your ranged troops engaging in melee combat anyway. The half damage penalty that is enforced for most unit types is a BIG disadvantage. If your Medusae can't turn the enemy to stone in their attack then they'll be smacked pretty hard next round.





**End Game:** Produce Scorpicores and Black Dragons bountifully. Scorpicores are a damn tough level 6 flier who's paralyse ability can come in VERY useful for temporarily neutralising annoying ranged troops or large squads of ground troops. Exercise caution however, although Scorpicores are tough their paralyse ability has only about a 50% chance of succeeding so don't rely on it too heavily. Black Dragons are NOT the cheapest thing on the menu, weighing in at a whopping 4k + 2 sulphur each to produce, however being immune to ALL spells and each Dragon having 300 hp is hardly anything to scoff at. Your Dragons will be able to deal and receive a pummelling, but as with all Dragons be aware that if you fly them directly into the midst of battle that they'll become the prime target of any enemy with a decent sized force so use them wisely.

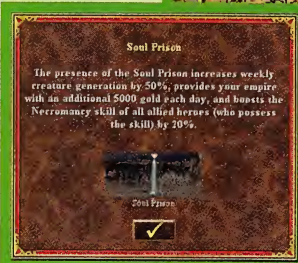

Thunderbirds on the other hand are a definite favourite. Their strength matches that of the Ogre Magi whilst their speed and defence are greatly increased. Allowing them freedom of movement whilst being able to withstand a few solid hits. Their lightning strike ability is a little hit and miss though. More often miss than hit. Nevertheless Thunderbirds are definitely a worthy addition to any Barbarian horde no matter what stage of the game.

**End Game:** Behemoths and Ancient Behemoths are really where the Barbarians get their own back. With the Ancient Behemoth reducing the defending creatures defence by a massive 80%, it's no wonder you better take these big boys down from a long way away. Their biggest disadvantage is that they're a large unit (2 squares) that doesn't fly. This enables enemies to position their troops strategically behind battlefield obstacles in order to keep your Behemoths on the run. Of course, with a speed of 9 they won't be hiding for too long, but a seasoned enemy will concentrate all their spells and firepower on taking out the Behemoths before they can wreak havoc among your troops.

### FORTRESS (BEASTMEN):

**Early Game:** Beastman troops begin the game quite weak. Their choice of early units (Gnolls, Lizardmen and Serpent Flies) puts them in an awkward position, as none are terribly powerful or effective in small numbers. Try and avoid any combat against other missile troops and stick to taking on packs of slower moving ground troops. The Beastman creed is opposite that of the Barbarian. Most of the creatures that are produced at the



Oh shit... run.

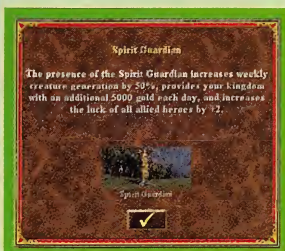

fortress have high levels of defence and should be played as such. Let the enemy advance whilst showering them with arrows and don't be afraid to let your guys take a knock or two. Chances are they'll have to, due to the lower attack skill.

**Mid Game:** Basilisks and Greater Basilisks are great mid range melee troops. Touting decent attack and defence skills mixed with a petrification ability makes the Greater Basilisk a staple troop in any Beastman army. Make sure to always have at least 5-10 in your group. They move at an average speed but can intercept troops well due to their size. Gorgons should be used almost exclusively as blockers to stop the enemy from attacking your Lizardmen. The Gorgon's attack strength is pitiful, but it's defence strength is very high indeed. If you can distract an enemy with them long enough for your Lizardmen to take down then you'll be laughing. The Beastmen's biggest drawback is their inherent lack of ranged troops. The Lizardman is the only troop type with ranged capability available to the Beastman and is a lower ranked unit type. As a result Beastmen suffer heavily and must guard them with everything available while they deal the most amount of damage possible.

**End Game:** Make good use of Wyverns. Their speed and strength combined with their flying ability makes them one of the most valuable units for the Beastmen. Wyverns were made to mix it up with up medium-heavy ground troops, but don't treat them as invincible. You are going to need to keep an eye on them just in case they get into hot water but generally they can hold their own. Hydras and Chaos Hydras are really only specialised units. They're great against clumped enemies and they can't be countered. However their low attack and defence rating makes them rather ill-suited against any kind of brawl against the stronger unit types (a Titan or group of Minotaur Kings for example). Use at your own discretion.





A solid overlord attack force should look like the one pictured

### GENERAL TIPS: BUILDING STRUCTURES:

As the unwritten law, always try and build your three lower level troop houses first. In most cases this will provide you with some ranged artillery and basic front liners to get you started. Once you've basic ranged weaponry and defense, the next thing you'll need to concentrate on is more income. Try and upgrade to your City Hall next. This requires you to build a Mage Guild Level 1, a Blacksmith and a Marketplace in most cases. Although the investment may seem a little steep to start with given the average amount of cash you begin with, but in the majority of cases players get cut short when they suddenly realize their 1000gp income per day just isn't making the grade. Once a suitable income has been established, try and then focus on your 4th and 5th level troop buildings. Oft times they're quite affordable and provide your heroes with a much stronger army. At this stage it then becomes a case of Might or Magic. If you continue to go for might, concentrate on quickly upgrading to a castle, then focus on building troop structures. This kind of tactic works well for any city that's seeing lots of heat and action.

Alternatively pour all your unused resources towards upgrading your mage guild to maximum. High level spells in the hands of high level mages are very deadly indeed. This kind of strategy is recommended only for cities that are either well covered or well defended, as pouring resources into magery leaves little for defense.

### PICKING FIGHTS:

Early on, try and always have a reasonable contingent of ranged troops in your group. This cannot be stressed enough. Pick fights with the smaller groups of weak creatures that may be guarding ore mines or wood mills in order to start earning some resources. Follow the same strategy as talked about above (that

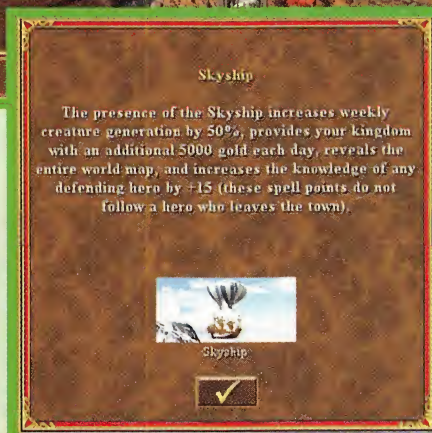

is, hold your weak melee troops back and have your archers take out the weaker creatures) and you should find you'll be able to walk through each battle with minimal casualties. It is highly recommended that you purchase two heroes at the start of the game. One to be the fighter that clears the path and the other be the explorer who probes and picks up wood and treasure for as far as he/she can without having to engage in any battles. This lets you establish a quick base of operations and knowledge of your surrounding area whilst picking up some goodies along the way. Once you've explored as far as you can go in all directions, take your heroes back to town (Which should be now house the 3 basic troop types at the least). Arm them with fresh troops, learn 1st level spells (Bless & Magic missile are invaluable) and push your boundaries a little farther.

### THE ARCANE:

Magic is one of the most valuable tools in the game. A high level spell casting hero can quickly tear apart their burly counterparts by a combination of strategic troop deployment and intelligent spell casting. Yet some of the most effective combinations are simply the ones that make the most sense. Bless large groups of archers and cover their butts. Seeing groups of 70+ Marksmen/Grand Elves completely CHEW through units such as Gold Dragons using this method is truly a sight to behold. Another goodie is the Gorgon/Shield combo, also known as the 'Tank'. Always try



and haste your lower level creatures. Generally you'll have about 80+ of them in a group. A group of hasted Battle Dwarves is a nasty sight because generally Dwarves are too slow to really be of any effective use. But they're tough as boots and brilliant to have in the front lines if you can get them there. I've even heard stories of people who'll go to the extreme with the Efreeti Sultan/Armageddon combo. The basic principle is that Efreeti Sultans take no damage from Fire, which is the type of damage that Armageddon deals. So whilst your entire army consists of a few Efreeti Sultans the fact that you can just Armageddon everything into oblivion is really of no consequence. This is a tactic that needs to be pulled off VERY early in the game though. Recommended for hotshots only.

### THE GRAIL:

The Grail is the Ultimate Artifact. Each obelisk visited reveals another small piece of the location of the grail. Each race uses the Grail to construct the ultimate building in their corresponding towns. In addition to looking really cool, the Grail provides the following base bonuses:

- +50% base creature growth
- 5000GP per day

### FINAL NOTES

Mastery of HOMM3 can be achieved only through practice. The strategies given here work well against the computer, and, used wisely and correctly can help to defeat other human players as well. Be warned though, we could probably print an entire issue based on the strategies and nuances of this game. What has been given here is a general overview to help you get started. Only you can help yourself to become a true master of the game.



# QUAKE NEWS

Trinity lives, while Generations joins the dearly departed. Elih Brading investigates.



## Foundations for the Future

The term "Trinity" was originally given to what was to be the next instalment after Quake2. id software, being the reputable decision-makers that they are, scrapped it for the hype that you see before you, the conceptual multiplayer game Quake3: Arena. Though the game hasn't eventuated, Trinity lives on.

Trinity has been thrown around the id offices since Quaker hit the shelves and is the codename given to Carmack's "next (game) technology" (ie, stuff you're yet to see in the current crop of id games, but features that are likely to be included as technology improves).

Although nothing is permanently set, the groundwork for id software's next game is under construction by Graeme Devine and incorporates a single player game that will take advantage of some of the "Trinity" technologies. Carmack has stressed that if the multiplayer focused Q3A flies off the shelves, the team will likely follow with similar products.

## GENERATIONS DELIVERED TO THE GRAVE

Generations, the mod that we here at PC Powerplay rave about (because it combines some of the most pleasurable deathmatch games of all time - Wolfenstein 3d, Doom, Doom 2, Quake and Quake 2), is officially terminated and all existing versions have been removed. This eventuation was delivered after the arguments surrounding the (End-User License Agreement) were clarified.

Lee'Mon (the lead developer behind Generations throughout all its incarnations) delivered the following statement:

*"Todd Hollenshead (id's CEO) has sent me the original emails regarding Generations. The wording in the two letters is, at best, vague. Neither side was able to fully determine the intent of the other. As a result, Generations has, for over a year, existed solely because of a misunderstanding between ourselves and id.*

*Due to the recent correspondence, however, this misunderstanding has been clarified.*

*Consequently, most of Generations is in violation of the current agreement, and cannot be allowed to continue.*

*id Software has specifically stated that they are NOT asking us to shut down Generations. Therefore, we are not technically "foxed," as the term*

*goes. But id has set guidelines as to what restrictions we are expected to place on ourselves. Generations, as far as v.98 goes, is in broad, direct, and clear violation of nearly all of these guidelines, in virtually every aspect. In fact, so is every version of Generations that has ever been publicly released. In case you haven't guessed, the Files page is down, and the mirrored downloads will soon be unavailable. In volunteering to remove the files, we hope to avoid any further legal complications with id Software.*

*The party appears to be over. I hate to see it end, but it was fun while it lasted.*

*For the last time, this is Lee'Mon, signing off for good."*

Although fans are disappointed, it seemed an inevitable course of action and anyone out there who holds v.98 now carries a collectors item. RIP Generations.



## MOD Of The Month

### Paranoid Quake2

<http://www.planetquake.com/paranoid/>

We all know the movie Aliens, a classic sci-fi movie heralded within the PC Powerplay offices as one of the best of its genre (Star Wars and The Matrix win of course). Paranoid is a teamplay mod which includes both the marine or the brood in a classical race-vs-race setup. Each member has abilities that you would expect: the marine is slow but packs supreme weaponry, while the brood is extremely agile and immune to lava - think of the surprise attacks you could pull swimming up to the opposition's bases! Paranoid wasn't available to download at the time of writing, but should be out well before this issue hit the shelves.



## Console Command Of The Month



### gl\_shadows 1

This OpenGL-based console command places shadows underneath all in-game Quake2 models. Although an unsupported feature that is seemingly incomplete (there are some graphical problems with the drawing of the shadows), it is recommended that you enable shadows. While it is mostly a visual addition, the shadows help to identify incoming projectiles and help to identify players at levels above you (I've flick-railed people jumping over my head based on their shadow placement and in-game instinct).



# MARINE OF THE MONTH

Quakez introduced a revolutionary system that took the inclusion of individuality to heights beyond that of simple skinning. Player models can now be made within 3D-Animation programs and viewed on your home computer. You could play as an alien, spy, businessman, helicopter or even Barbie - the limits as endless as your imagination. Each month we'll review one of these plug-in player models, and there are 11 of them (including this month's favourite) on the CoverCD to get you started.

## Paranoid Marine

<http://www.planetquake.com/q2pmp/>

The paranoid marine is a player model developed specifically for this month's recommended mod - Paranoid Quake2. It includes four skins, custom sounds and is one of the most realistic player models available for Quake2. Though it lacks originality and has some graphical errors while crouching, this model is a definite addition to your players directory.



## Quake3: Arena Quick Facts

- currently there are 30 Deathmatch arenas that are nearing completion
- the included weapons stand as follows: the gauntlet, machinegun, shotgun, grenade launcher, rocket launcher, lightning gun, railgun, plasmagun, flamethrower and the BFG.
- there are 10+ models that are in the final development stages.
- the architecture and map difficulty increases as you get higher in the ranks while playing bots.
- the tournament map and test phase2 should be out by the time you read this.



## Alias Of The Month

alias +lag "set origrate \$rate; rate 1"  
alias -lag "set rate \$origrate; echo Rate: \$rate"  
bind <key> "+lag"

The anti-lag alias is useful for Internet games where you get the dreaded, dropped packet symbol. This script will make your modem download fewer frames in an effort to regain gaming stability. Once you regain gaming control, toggle the button to return to smooth gameplay.

# HAVING TROUBLE GETTING PAST THE HARD BITS? YOU CAN HAVE CHEAT CODES • LEVEL WALKTHROUGHS • TIPS & TACTICS • ALL THE GAME HELP YOU NEED RIGHT NOW!

Next Gaming's Institute of Responsible Cheating brings you the gaming salvation you need!

FAX-ON-DEMAND gives you the help you need and is

just a phone call away.

What's more, each

FAX-ON-DEMAND

has been hand-crafted to cram as

much helpful info

on a page as

possible, so you know

you're getting value.

Plus, we give you

bonus cheats and

game advice! Each

FAX-ON-DEMAND has

been carefully designed

to look good and be readable

regardless of how old your fax

machine is! Too good! To make

your life easy, we've split up each

game so you can cut straight to

the chase - you only pay for the help

you need!

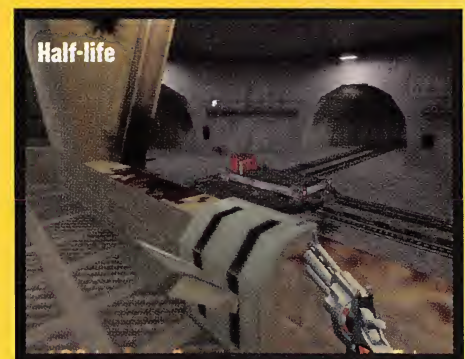

**1902 220 423**

## THE GAMES

Yell and scream if the games you want aren't here! We'll do our best to keep you happy. Email us ([pcpowerplay@next.com.au](mailto:pcpowerplay@next.com.au)), fax us (02 9310 1315) or write (FAX-ON-DEMAND, 78 Renwick St Redfern NSW 2016).

### Commandos

- 100 Missions 1-4
- 101 Missions 5-10
- 102 Missions 11-17
- 103 Missions 18-20 plus tips & Survival tips

### Half-Life

- 110 We've got hostiles
- 111 Power Up, On the Rails (Part 1)
- 112 On the Rails (Part 2), Apprehension, Residue Processing
- 113 Questionable ethics, Surface Tension (Part 1)
- 114 Surface Tension (Part 2), Forget about the Freeman, Lambda Core, Xen, Gonarh's Lair
- 115 Interloper, Nihilanth and weapon descriptions

### Dune 2000

- 120 Atreides Missions 5-7
- 121 Atreides Missions 8-9, Harkonnen Mission 5
- 122 Harkonnen Mission 6-9
- 123 Ordos Mission 5-9

### Starcraft

- 130 General strategies, Protoss
- 131 Human, Zerg

### Forsaken

- 140 Volcano subway, nuclear power station, thermal power station, FedBank, Prison Ship, Asteroid Base
- 141 Bio-Sphere, Subterranean Complex, Capsized Ship, Orbital Station, Shuttle Bus, Military Bus, Tloloc Temple, Secret Level

### Rainbow 6

- 150 General tactics, cheats, weapons
- 151 Missions 1-16

### Dark Reign

- 160 Freedom Guard 3-5
- 161 Freedom Guard 6-8
- 162 Freedom Guard 9-12
- 163 Imperium 3-8
- 164 Imperium 11-13

### Blade Runner

- 170 Act 1, Act 2 Tyrell Building, Police Station
- 171 Act 2 (from Animoid Row), Act 3
- 172 Act 4, Act 5

### Curse of Monkey Island

- 180 Parts 1 & 2
- 181 Parts 3, 4, 5 & 6

### The Last Express

- 190 All Q&A



## How to use FAX-ON-DEMAND:

1. If your fax machine has a phone handset, pick it up and dial 1902 220 423. Follow the instructions given by the warm and friendly mystery voice. You will be asked to key-in the 3-digit code for the game/games you want faxed-back.
2. If your fax machine DOES NOT have a handset, ensure your phone is on the same line as the fax, or use the fax's SPEAKER function. Dial 1902 220 423 and follow the instructions. Press 'Start' on your fax when the voice asks you to do so.
3. Stand back and marvel, as moments later the game help you need rolls majestically forth from your fax machine.

Important: All calls are charged at \$2.50 per minute. Calls from mobile and pay phones may attract a higher rate. Make sure you have permission from the person who pays the phone bill if you're under 18! All charges will appear on your regular phone bill.

TECH SUPPORT. If weird stuff happens, or nothing at all, call 02 9212 4222 for help.

Ashton makes sense, often.

**W**hen you write, remember to include as much pertinent information as possible. Send your CONFIG.SYS and AUTOEXEC.BAT and any associated \*.INI files for Windows that might tell us more about your problem. Give us as detailed an explanation as you can and be sure to include as much detail as possible about your PC. Feel free to email your questions or, if you want to snail mail, please remember to write clearly or better still, print your letters. Please note that due to the volume of messages we receive, we cannot guarantee a response to your queries.

**Setup**  
**PC PowerPlay**  
**78 Renwick St**  
**Redfern**  
**NSW 2016**  
[setup@pcpowerplay.next.com.au](mailto:setup@pcpowerplay.next.com.au)

## Twice as fast?

**Q** Your mag is great, a lot better than the expensive foreign mags. Now I have an important question for you. If you have a dual motherboard and say 2 Pentium II 450s does the machine run at 900mhz or only at 450mhz still. I have been told by a friend that having a dual processor machine is not any better, because most software does not support dual processors, but I don't believe him so can you clear it up for me. I am looking to upgrade and I don't want to waste my money if I don't have to.

**Shane Murphy**

**A** Your friend is right. Having two CPUs won't mean a thing if your operating system and applications aren't designed to take advantage of the extra CPU. And no, your machine wouldn't run at 900MHz, you simply have two 450MHz CPUs each running whatever tasks the operating system assigns to them. See the letter 'Dual CPU power' elsewhere in Setup for more about dual CPU systems.

## Clocking to an Ultra

**Q** OK. First off, thanks Ashton for the great tech section. It's almost single-handedly helped me with building my new computer and overclocking it to hell (Celeron 300a to 464... ooh baby). Anyways, I need a new video card and was looking at one of those new fandangled TNT2's to replace my almost dead Voodoo and S3 Trio (talk about underpowered!). Now there are two flavours right, the "normal" vanilla TNT2 clocked at 125Mhz and the "Ultra" double-choc clocked at 166Mhz (or thereabouts). And the only thing that decides what the cards are going to be clocked at is the whim of the board vendor eg Diamond, Leadtek etc (if I understand correctly!). Now, if this is true, and the only difference between the two models (not taking into account amount of memory on board) is their clock speeds, then wouldn't it be somehow possible to overclock a "normal" TNT2 board to the specs of an "ultra" without fear of blowing the poor thing up? Or will/have the board vendors clock-lock/ed 'em? I pray like hell it's possible, as it will give hope (just like the Celeron 300a did) to overclockers and gamers everywhere.

**Daniel Whittaker**

**A** It's not quite as simple as that. There is a difference with the ultra cards. For a start, as with CPU production, those 'ultra' chips that didn't make the grade and stay stable at the higher clocked rating are sold as a standard TNT2 chips. This means it is indeed possible to overclock them just as easy as overclocking an ultra TNT2, but the maximum limit will be lower and probably won't stay too stable at the clock rate Ultras run at (150/183, I think). But it's not that easy - Ultra cards are also equipped with faster RAM (5.5 ns or less, whereas standard TNT2 cards might use 6 or 7 ns), and this will likely limit how high you can overclock more than the maximum stable clock of the TNT2 chip itself. If the RAM can't take the speed, overclocking the TNT2 chip isn't going to help (well, you can just overclock the TNT2 and not the RAM, but you get far greater performance benefits by overclocking the RAM in line with the TNT2 chip). Standard TNT2s don't necessarily come with fans either, so you should certainly consider attaching one if you're going to overclock it.

## Fridge it baby!

**Q** Alright alright, I know Celeron processors rock for hardcore gamers, but for people who are left in the dark like me, I would like to know if I would be able to overclock my Pentium II processor to the extent of a Celeron? Let's say, if I overclocked my Pentium II 300mhz to 366mhz, would there be any major problems such as excessive heat?

I also have this question to ask. It's kinda silly, but I would like to know if I overclocked a Pentium II 300mhz to 600mhz (let's just



Letter of the Month  
Win a **PSI Hercules**  
**Dynamite TNT**

## Anti-viral woes

**Q** I have a 233 Cyrix computer with 32 meg RAM. Just recently I decided to shell out the dosh to buy Norton Anti-Virus V5.0. My lovely game munching machine is now as slow as anything. It used to take about 30 seconds to boot up and load Windows 95 but now it takes 1 to 2 minutes.

Also, in the Windows environment if I start running multiple programs I start to get "lag". I wanted to know would it be that I'm lacking CPU power or that I don't have enough RAM? Win95 only needs 16 meg of RAM doesn't it? Thank you for your help.

**Dean Mueller**

**A** Firstly the reason you've noticed a sudden slowdown is that good old industrial strength Norton Anti-Virus installs a resident program that scans everything you load, everytime you load something. Wether you start Notepad or Quake, Norton will scan it for viruses as it loads, and this takes time. It also starts a scanner during boot up to check boot sectors and critical files, and this slows down your bootup.

This is just Doc Ash's opinion, but this is all overkill. If you suspect you have a virus, then by all means do the full works and scan every single file on your system using a virus checker like Nortons. Doing it everytime you boot

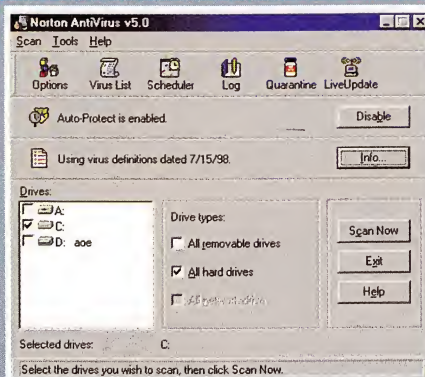

**Overloading active utils like virus scanners can seriously slow things down.**

up and everytime you run a program is paranoia. To be fair, this is a good plan for a work PC open to viruses on a network, but not for your home PC when the only new files that come along are the odd game demo or two you download every now and then.

However, having only 32M doesn't help, especially when you're running a memory resident program that checks for thousands of viruses everytime you use your PC. Buying more RAM will speed up everything - Windows and games included - irrespective of whether you're running a virus checker or not. But definitely remove Norton from your startup and disable the memory resident checker. If, later, you suspect something dodgy is going on, start the scanner and do a full scan of your system at that time. If you're careful and scan new programs just once after you install or copy them, that should pretty much safeguard you against viruses without having your precious gaming machine slowed by unnecessary programs.

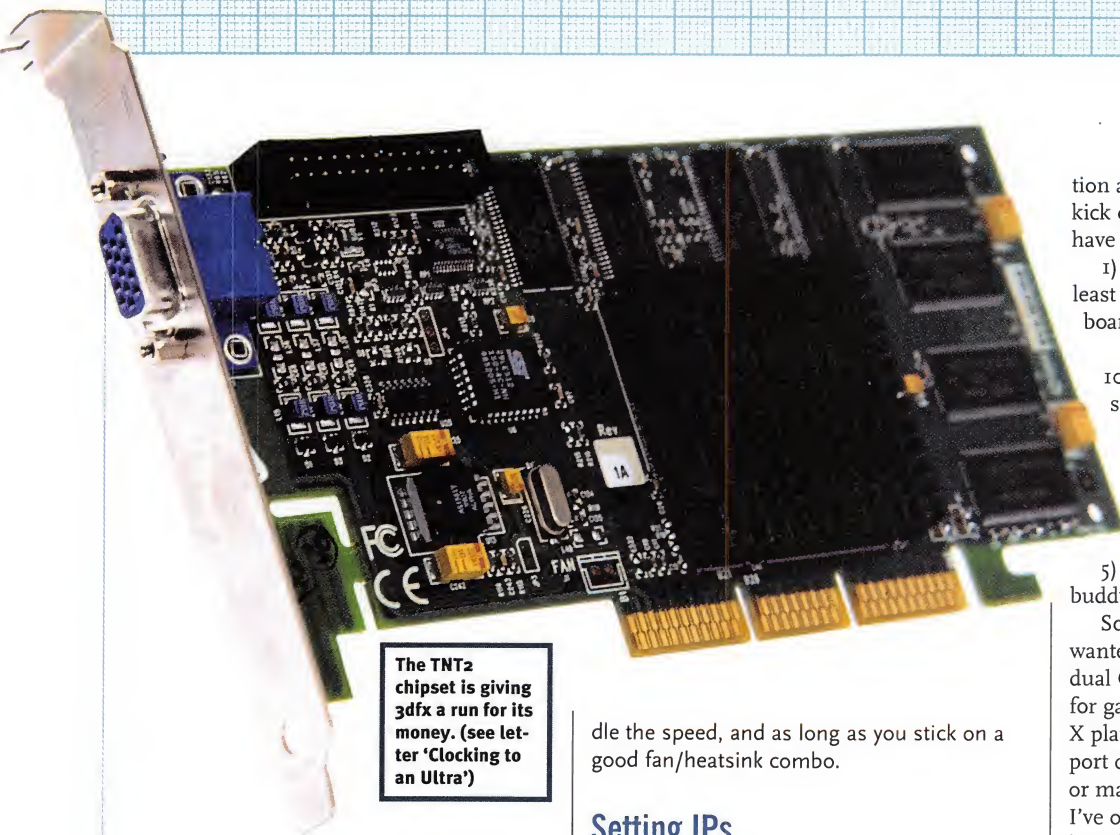

The TNT2 chipset is giving 3dfx a run for its money. (see letter 'Clocking to an Ultra')

say there was a motherboard that could do it) and I then shoved the computer into my freezer, would it run OK? After reading your magazine I saw all these overclocking freaks using special cooling systems to cool the CPU down, why can't I use my freezer as a special cooling system?

**Ken Wong**

**A** Well, for starters your freezer is wet. Water is a great conductor. The cold air would condense on your live hardware and this will lead to much shorting and fried parts and fun to be had by all. While the temperature of a freezer might be handy to cool a system, the freezer itself is not. This is why people go to great extents to build cooling systems, because it's not just a matter of getting heat away from the CPU, it's a matter of doing it safely.

Some of the more bizarre cooling methods you see on the Internet use water cooling via pumps, special oils to submerge parts in, or compressors similar to those in fridges — but often only covering the CPU. Such systems are bulky, hard to setup and susceptible to problems (unless you go to the experts such as the lads at Kryotech.)

So, for most of us, trendy and powerful cooling systems are beyond reach. But no, you shouldn't suffer any problems overclocking your PII 300 to a PII 366 assuming the L2 cache chips can han-

**Fridge. Place to store beer. Not PCs. (see letter 'Fridge it, baby!')**



dle the speed, and as long as you stick on a good fan/heatsink combo.

## Setting IPs

**Q** I've got a problem with my network. I've got two computers hooked up - both with the same network cards which are NE2000 Compatible. The computers work fine using IPX, but when I need to use TCP/IP for games like Descent Freespace the game can't find either computer, and I have TCP/IP installed on both. I have uninstalled and re-installed the card and the software 3 times but still get the same problem - they just can't find each other. Any hints?

**Makara**

**A** You need to make sure you've assigned each machine a unique TCP/IP address on the network. To do so simply click Start —> Settings —> Control Panel —> Network —> TCP/IP —> Properties —> IP address. Select to specify one and type in a value like 192.168.0.1 for the first machine, 192.168.0.2 for the second and so on. Then, set the netmask to 255.255.255.0 for all machines. You'll probably have to restart Windows, after which you should be able to ping the address of any machine on the network. If you can ping a machine, then games that use TCP/IP will be able to find other machines on the network.

## Dual CPU power

**Q** I have the feeling this has been asked before, never the less, I've always wanted a dual CPU board but have wondered about support etc. Ok mainly it would be for games, but image manipula-

tion and decompression would have to get a kick out of it, and theoretically they would have the funkiest benefits:

- 1) Upgrading would be worry less for at least a couple of years, that's assuming the board had good 'future upgradability'.
- 2) Instead of going and forking out a 1000 bucks for a nice PIII 450, you could stick in a couple of beefy Celeron A's and still get pants soiling performance.
- 3) double OVERCLOCKING!
- 4) TRUE multitasking, not the ho-hum time sharing that Windoze uses.
- 5) The sheer experience of telling a gamer buddy that you've got 2 CPUs!

So you get the idea, but that's not what I wanted to ask. I know Linux and NT support dual CPUs, but they aren't exactly the choice for games. What about the regular Windows X platforms? Do games have to directly support dual CPUs, or just the operating system or maybe the rendering API like DirectX? I've only seen one or two ads for dual CPU boards, and they were just for server machines. Why aren't they more readily available, is it the cost or support or what? Anyhow if games don't support 2xCPU's, why hasn't there been more of a push in this direction? Is it that much of a task? The potential seems so great.

Thanks.

**NotSoGrandInquisitor**

**A** If you want to take advantage of multiple CPUs the operating system must support it. Windows 9X doesn't support multiple CPUs but, as you've said, NT and Linux do. You need an operating system to support multiple CPUs because it's up to the operating system to dole out tasks as it receives them to the least encumbered CPU. Applications can be written to take advantage of multiple CPUs, but they still require an OS that is SMP (Symmetric Multi-Processing) capable.

There hasn't been much of a push for developing games that use multiple CPUs for the simple reason of market share. How many people do you know with dual CPU systems or could afford one if they wanted one? Not only do dual motherboards cost more, but you need to invest in two CPUs.

It's a nice idea however and the cost of building a dual CPU system is coming down every month (well, everytime CPU prices drop) and no doubt there are many possible advantages to developing games to take advantage of it. Conversely, it might just be easier to run games on a single, faster, CPU for the same cost as the two slower CPUs, so really not that much is gained. You will sooner see multiple CPU machines being used as game servers and those servers programmed to take advantage of multiple CPUs - you can bet this is the case for the servers that keep UO and Everquest running, and you can rest assured they're running a form of Unix or NT.

I wouldn't be too concerned about multiple CPU systems, perhaps in the near future

there might be larger call for such systems on the user end, but with faster CPUs coming out every year, a single CPU system will likely be enough for our glorious games for some time to come.

## TNT compatibility

**Q** I read the article on the new 3D accelerators in last month's issue and I am convinced that the Riva TNT 2 is a better card than the Voodoo3, but when I went to buy one at the shops the sales assistant told me that they don't stock the TNT2 because they aren't compatible with many games yet. I didn't realise this, and what I want to know is if I buy a TNT2 can I take it home straight away and use it on Half Life, Unreal, Quake I and II and all my other games, or will I have to wait for a compatible game to be released? Thanks a lot.

Ryan

**A** No, your games will work fine, unless they are glide only. Glide is a dying API, however, and already fewer and fewer games are supporting it. Instead, most 3D games (and in the near future, all) support Direct3D and OpenGL. D3D and OpenGL is supported on all cards, even 3dfx cards (though their OpenGL implementation leaves something to be desired), so why would a developer spend time programming for glide when only a subset of the market can use it?

Make no mistake, 3dfx did well with their API by making it easy for developers to get into programming for 3D hardware, but the API has served its use and compatibility is no longer an issue when it comes to purchasing a 3D card.

## Future of technology

**Q** While watching Beyond 2000 a couple of months back, they were talking about the Millennium Bug and about CPU's. They said, apart from the bug, the computer industry will hit another snag at around 2010. The problem was that computers have doubled in power and halved in size around every 18 months, and this cannot continue on forever. They said that the silicon semi-conductors, will reach their physical limit. To get compact, they need smaller switches using fewer electrons, the fewer electrons doing the switching, the more chances of a mistake.

Now if this is true, would this be a good or bad thing. One would say that we no longer have to keep on upgrading, but on the other hand, we could be restricted to a speed-limit for the rest of our lives.

I'm sure a tech-head like yourself could tell us consumers what could happen? Could it be, motherboard manufactures will find a way to use two CPU's in tandem with one another?

Raulan Grajewski

## TCP/IP Properties

Bindings | Advanced | NetBIOS  
DNS Configuration | Gateway | WINS Configuration | IP Address

An IP address can be automatically assigned to this computer. If your network does not automatically assign IP addresses, ask your network administrator for an address, and then type it in the space below.

Obtain an IP address automatically  
 Specify an IP address

IP Address: 192.168.0.3  
Subnet Mask: 255.255.255.0

OK Cancel

Setting up TCP/IP is easy. (see letter 'Setting IPs')

**A** The process of doubling computing power every 18 months is known as Moore's Law. So far, it seems, it's proven to be true. But I don't think we'll ever be speed limited however, as technology will always find a way to create faster and smaller CPUs.

For example, it's true that we are slowly approaching the limits of silicon based chips for both speed and size, but the previously thought limit has already been improved upon by the scientists at Bell Labs who recently discovered that the smallest current technology can go is five atoms of silicon dioxide. Research has also been done into using biological cells as switches as well, so other possibilities are available. Rest assured, you'll be in the upgrade cycle for as long as you walk this Earth (or choose to live the life of a geek and gamer).

As for using multiple CPUs, you can already do so today. You just have to use an OS that can take advantage of it like Windows NT or Linux. Although applications can be programmed to spawn tasks on multiple CPUs, it's up to the OS to handle load balancing across the CPUs to make the best use of

system resources. CPUs aren't so much used in 'tandem' but rather processes, unless otherwise specified, are run in turn on the least loaded CPU at the time a new process is started. This is known as load balancing.

## Sexy cases

**Q** Are you aware of Apple's G3 cases (the ones that open side-ways, with the motherboard attached for easy access) being available for Wintel users? If not, is there anything similar in Wintel land? The situation called for it long ago - especially with all the upgrading and over-clocking that we are forced into to keep playing the Half-Life's and Quake 3's of today and tomorrow. How often would Mac users need to get inside their 'machine', anyway?

Or, what about the availability of the cases that Creative use in their 'Blaster PC's' for non-Creative computers - the cases are black (which you'd love) and have all the I/O ports, like joystick, speakers etc, at the front of the PC instead of the back - very cool!

Anyway, thanks for your help.

Nathan Hobbs

**A** There is something similar in Wintel land, but you have to shop around. Recently case manufacturers have been producing easier to use cases that sport slide in motherboard and drive brackets, easy case removal and so on. They're not as user friendly as the Apple cases yet, and they can be hard to track down, but they do exist.

Alternatively, you can be a little eccentric and purchase fancy cases such as those made out of wood or sporting sleek, modern designs and colours which make the boring old beige cases look ancient. Surf to <http://slashdot.org> (it's a geeky news site that every computer user should read), scroll to the bottom and do a search on 'computer cases' and you'll get a selection of news stories pointing to cool cases made from companies all over the world.

Of course, you could always do it the manual Doc Ash way and just line your PC up against a brick wall somewhere and take to it with a can of black spray paint (for those wondering what happened to my old black PC when I got my new PII system, it's now an in-house Linux server storing games and MP3s).

I completely agree with you though, in this day and age we continually pull apart and fiddle with our metallic bundles of joy, and it would be so very nice to be able to do so with a minimum of fuss and damage to one's hands.

### Lord of the rings

**Q** Hope you can help me with this. I have got the Cambridge PCWorks fourpoint surround speakers and an ADI 17" monitor. The problem is that when I use the scroll on the Microsoft mouse, for say, a Word document or just in Explorer the speaker starts to crackle and the song starts play in slow motion. As soon as I let go the scrolling everything is back to normal? This

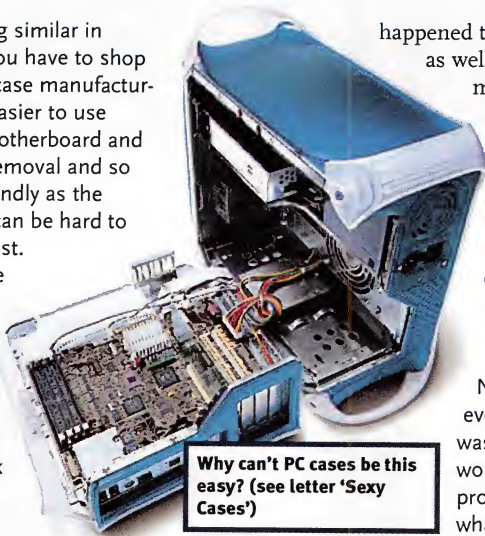

**Why can't PC cases be this easy? (see letter 'Sexy Cases')**

happened to my old speakers as well. Anyway, great mag, and thanks for the help.

**Faijay**

**A** It's not your speakers. I first encountered a similar problem using WinAmp and Netscape — whenever the scroll bar was used, the MP3 would stutter. The problem arises, from what I can tell, because of the way

Windows is designed.

Rumour has it that Microsoft have programmed the GUI at what's known as 'ring 0', meaning it operates at the highest priority within the CPU. Programs that run at 'ring 0' have unrestricted access to memory and CPU functions. By comparison, standard application programs run at 'ring 3' and are prevented from issuing certain instructions to the CPU that could cause instability.

Programming this sort of trick has three results: Firstly, the GUI is very fast and very responsive, giving the illusion of a slick UI. Secondly, if the GUI should crash it brings the whole machine down — something all Windows users can attest to. Thirdly, programs that run at 'ring 0' automatically receive priority over those running at a different level.

The result is that the GUI will always be responsive at the expense of other programs running on a system, such as an MP3 player. This effect can be seen by starting a CPU monitor and dragging a window around on the desktop - try it and see what effect it has on the monitor.

One way to get around this problem is to try a different, less CPU intensive, MP3 player. Some players suffer this problem less, if at all.

## Tech Tips

Tips to help you get the most out of your machine

More reader submitted tips this month. Keep them coming!

### Shifty

Did you know that there is a magic key in Windows? Its the plain old 'shift' key. Hold it down while deleting items to bypass the recycle bin, double click on a folder with the shifty key, and it opens Explorer, drag .exe's to other folders and it will move them there instead of making a shortcut. Hold down shift while restarting your computer (my favourite), and it restarts the computer heaps faster.

Try some of your own combinations. I'm sure that there are more out there.

**Michael Tudor**

### Why USB?

**Q** Most of the new joysticks and gamepads on the market seem to be USB. In what way are the USB devices better than the older ones that plugged into the gameport on the soundcard?

**Pete Harvey**

**A** The devices themselves aren't necessarily better, it's just that USB makes it easier to handle on the PC side of things. Also, USB has fancy features like providing power for devices and, more importantly than anything else, allows you to chain many devices together off the one USB port. You can link keyboards, mice, joysticks, monitors, digital cameras, printers and more from a single USB port, greatly increasing the number of devices you can attach to a PC over the current two serial, one parallel port, one joystick port limit.

Monthly accounts \$24.95 to \$34.95  
in Sydney & Melbourne

\$2.50 per hour in Other Cities  
Bris/Ade/Per/Hob/Can & More

Web Hosting Packages from \$790  
<http://www.yourco.com.au>

Phone 1 800 000 890

<http://www.ar.com.au>

**AR** INTERNET

A.R. providing online services since January 1994.

THE 4<sup>TH</sup> COMING

Multi-Player Online  
Role Playing Game

<http://www.t4c.com.au>

\* 100 Players \* 300 NPCs \*  
200 Monsters \* Spells

for Windows95/98/NT  
32 bit - Direct X

Server located here in Australia  
for fastest low lag play

# 3D TECHNEWS

AMD K7 'Athlon': A New Choice for Gamers on the Horizon. By Hugh Norton-Smith



## AMD K7 'Athlon' Architecture:



- Clock speeds of 500, 550 and 600 expected at time of debut.
- 128 KB of L1 cache integrated on-chip.
- 2-way set associative 64 KB Instruction cache and a 64 KB Data cache.
- 512 KB to 8 MB of L2 cache on card running at 0.25, 0.33, 0.5 and 1X the core speed. It is expected to ship first with 512 KB at 1/3 core speed.
- 0.25 Micron process initially. Expect this to be reduced to .18 in the next year. .25 will allow for higher theoretical clock speeds, lower voltages and increased overclockability.
- 184 mm Die size with 22 million transistors.
- 3D Now! Support.
- 3 Parallel x86 instruction decoders.
- Dynamic scheduling with speculative out-of-order execution.
- 2048-entry Branch Prediction Table & 12-entry Return.
- 3 Super-scalar, Out-of-Order Multimedia Pipelines with 1-cycle throughput.
- 9 Issue super-scalar, super-pipelined design for high operating frequencies.
- Multi-processor capable.
- Slot A type motherboard interface using the Alpha's EV6 architecture. Initially expected to be running at 200 MHz.

It was only last month that National Semiconductor decided to shut down its beleaguered chip fabrication wing, Cyrix. This has left the CPU industry with two main players: American Micro Devices and Intel. In recent years, the underdog has been fighting a losing battle. The first of several disasters for AMD was the much-ballyhooed K5. Despite AMD's assurances, the chip failed to deliver performance in the same ballpark as the Intel Pentium. To add insult to injury, the excellent K6 chip was marred by repeated delays, distribution problems and poor processor yields.

So, AMD are gambling on the K7 'Athlon' to pull it out of financial troubles. AMD will unveil the 'Athlon' processor within the next few weeks, signalling a last ditch attempt to compete with the ubiquitous Pentium range of processors from Intel. A word of warning however to you budget system assemblers: Unlike recent processors made by AMD, the 'Athlon' won't be a bargain-priced chip destined for use in low-priced computers. It will initially be aimed at the hardware gurus, gaming aficionados and the server market. Analysts expect the 'Athlon' to be released at a price point similar to the top end Pentium III CPUs.

### Gaming Nirvana

Traditionally, AMD have released CPUs that are significantly cheaper than their Intel counterparts, whilst offering similar performance. But, with the Celeron price drops and the introduction of the Pentium III, AMD has been under increasing pressure to release a successor to the venerable K6 line. Poor sales of their current flagship AMD processor, the AMD K6-III, coupled with its less than stellar performance, means that AMD need a successor soon. The main problem with both Cyrix and AMD chips has always been

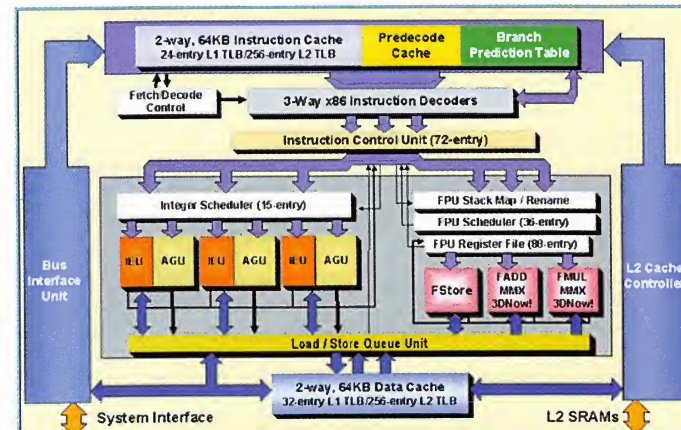
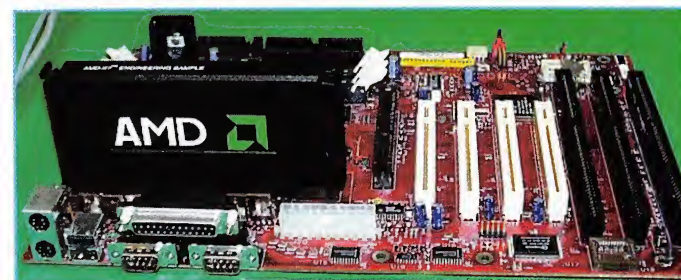
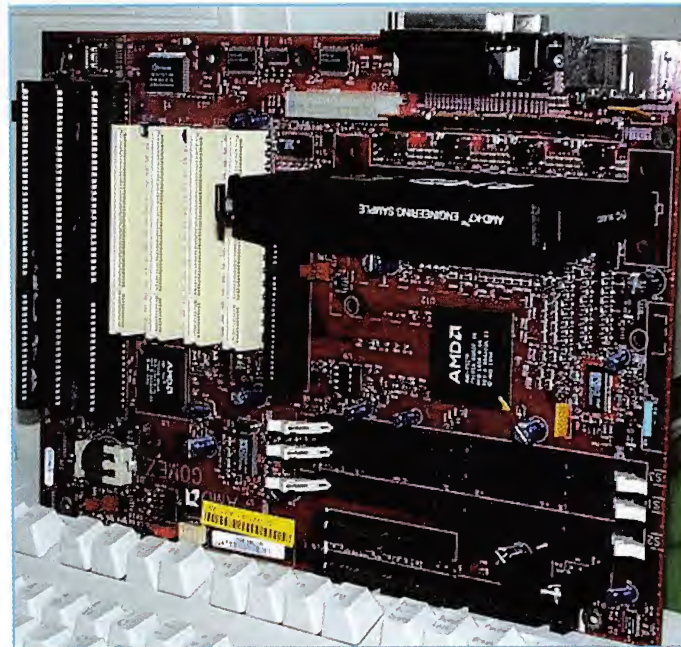

This flow-chart actually means something. It's of the instruction set for AMD's 'Athlon' K7 chip.

their mediocre floating-point performance. We at PC PowerPlay have always recommended Intel chips over their AMD counterparts, as the floating point performance of a CPU is enormously important when reproducing

3D environments and high-speed rendering.

As you probably know, the K6-III is a terrific business application performer but lacks strength in intensive floating point applications like 3D-animation packages



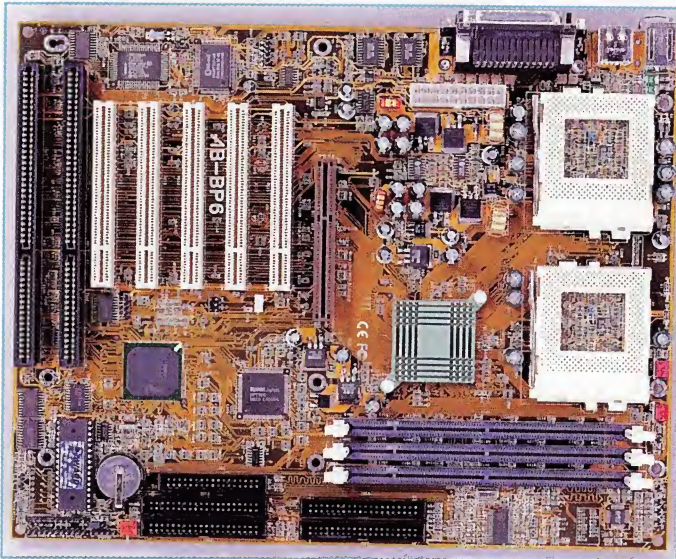

Yes kids, that's two CPU sockets on the right.

and Quake-style games. In those applications, the PIII and its cheaper (although no less competent) brother, the Celeron are the undisputed rulers. Much of the hardware community was of the opinion that the K6 was a great design, but failed to reach its full potential due to its lack of a pipelined floating point unit. So, much to the delight of hardware enthusiasts, AMD have given the 'Athlon' a super-pipelined FPU. To cope with the increasing strain of 3D gaming the K7 'Athlon' has been designed right from the start to have an awesomely powerful x86 floating point unit.

#### True 4th-gen CPU

Let's get this straight: The Athlon is a true seventh-generation x86 processor in all respects. The Athlon isn't merely a rehash of the K6 with a bit more cache and some new instructions strapped on. This beast has been engineered from the ground up for blazing performance. This is quite opposed to Intel's current batch of processors, which are all based on the same core as the antiquated Pentium Pro (Celeron, Pentium II, Pentium III and Xeon). The K7 looks like a seriously fast CPU on paper. Since we don't have any completely reliable benchmarks as yet, we can't give you any exact details of the Athlon's performance. No one outside AMD will be sure how strong the 'Athlon's' performance is until independent tests are completed in the few weeks after shipments begin. However, AMD's own measurements of the chip's performance were released to industry analysts earlier this month. For business

applications, the 'Athlon' chips ranged from 5 percent to 15 percent faster than the fastest Intel chips. And for 3D games and multimedia applications, the 'Athlon' creamed Intel's high-end Xeon processor by a good 35 percent to 40 percent, AMD has claimed. And supposedly, this was with the 'Athlon's' cache running at half speed and the software unoptimised! There is no doubt however, that with its improved 3DNow! units and three independent floating point units, the 'Athlon' will have superior gaming performance to any x86 CPU in existence today. Potentially, that difference could be even higher for double precision FPU intensive applications.

#### Look out Silicon Graphics!

If all the above specifications have failed to impress you, the 200MHz EVA Slot A bus should. A bus is the interface between the CPU and the mainboard. Slot A is physically identical to Intel's Slot 1 but incompatible electrically. This will allow Slot 1 motherboard manufacturer's to produce Slot A motherboards at reduced cost. The theoretical bandwidth of the new 200MHz system bus is 1.6GB per second, which is twice that of the Intel BX chipset, which operates at 100MHz.

So how did AMD manage to develop such an advanced system? AMD licensed the radical new technology from Digital, who manufacture some of the most advanced chipsets available. The bus also has the ability to be easily integrated into a multi CPU setup. With the upcoming release of Windows 2000 and the increasing popularity of Linux, multi-processor systems

will be an increasingly viable option, due to their substantial performance increase and the expected drop in prices.

Already, a company known as Poseidon Inc has announced plans to release a motherboard that supports eight 'Athlon's in parallel. That would be one helluva ninja Quake rig! No need to throw out your old RAM, however as the 'Athlon's' 200Mhz bus will be compatible with generic PC100 SDRAM. Since this will be the only readily available technology available in August when the 'Athlon' is scheduled to launch, AMD have abandoned attempts to incorporate RDRAM support in their chipset. The memory manufacturers are certainly undecided as to the benefits of RDRAM, so AMD have been forced to adapt the hardware to accept standard PC100 DIMMs. Hopefully there will be support for RDRAM and PC133 by the end of this year.

Personally, I think that the 'Athlon' will be a huge success for AMD, if they can manage to produce the chip in large quantities. Only time can prove me prophet or ape, but either way, AMD's new baby should be of great interest to the hardware community.

## Quick Bytes

#### Abit BP6: Dual Celeron Board

The Taiwanese motherboard manufacturer and darling of overclockers everywhere, Abit, have announced a new motherboard that supports the Intel Celeron in dual configuration. The novel feature with this board is the ability to run two Celeron in 'master/slave' mode. In a conventional system, you need to use two processors of the same speed for dual mode to work. With the BP6, you can use two Celerons of different speeds. The overall speed will equal the addition of the two speeds. The master CPU will handle most of the workload, so naturally this is where you want to put the faster CPU. The Abit BP6 will include the usual range of overclocking features, including voltage selection and the speed of the front side bus.

#### Windows 2000

Microsoft is unrolling an entirely new operating system this November. The new OS is supposed to mesh the stability and robustness of NT with the

## CPU BUYER'S GUIDE

Despite my enthusiastic preview for the 'Athlon', the CeleronA remains the best bang for buck. With its dirt-cheap price, extensive overclockability and powerful FPU, you can't go past this little screamer. Gamers should steer clear of the Pentium II, however. The Pentium II offers performance that is almost identical with the Celeron at a grossly inflated price. Same goes for the AMD K6-III. Whilst they are competent processors, both the K6-2 and K6-3 should be avoided by users who want the best gaming experience. For the power user with a sizeable budget, the Pentium III at 550 MHz wins hands down, albeit at an absurd price. However, if you're prepared to hang out until late August, the Athlon could be a worthy alternative to the Pentium III. Not only is the architecture of the Athlon significantly more advanced than the Pentium III, but it will be released at higher clock speeds. A 600 MHz version will be released at launch, which will only be matched by Intel in late November. The 'Athlon' is one CPU I want to get my grubby little hands on. Look for a comprehensive review soon.



multimedia features and compatibility of Windows 98. Despite a few small problems noticed with the beta version we have, Windows 2000 is set to be the gaming platform of the future. It's loaded with extra features, interface tweaks, enhanced hardware compatibility and a blazing fast, fully 32-bit kernel. Windows 98 and its DOS legacy have finally been done away with. Win2000 will come bundled with DirectX 7, allowing for cutting edge graphics and compatibility with older games.

#### Metabyte SLI

An American company is marketing a new technology that allows almost any two videocards to be run in parallel. Reminiscent of 3dfx's SLI (Scan

Line Interleave) technology, Metabyte's ability to combine any two next-generation video cards should increase frame rates dramatically. This can be applied to both modified Voodoo3 and TNT2 cards. The technology will initially be sold via Alienware.

## Linux: An Alternative to Windows?

There's been an awful lot of hype for Linux recently; Linux is the freely available UNIX based operating system that works an 'open source' development model. Dramatic improvements in the graphical user interface have allowed Linux to capture a sizeable portion of the desktop market. Some very important games have been written for Linux, including Quake 3, Myth II, Civilization: Call to Power, Descent, Doom, Ultima Online. Many more are on the way. In the past month, OpenGL drivers have been made available for almost all videocards under Linux. The advantages of Linux include fully 32-bit operation, support for multiple CPUs and rock solid stability (no more blue screens!). For more info check out [www.linux.org](http://www.linux.org)

## Hardwired Hardware Web Links

[www.voodooextreme.com](http://www.voodooextreme.com)

News, reviews and Gary Coleman. The original and best.

[www.tomshardware.com](http://www.tomshardware.com)

The god of benchmarking....

[www.anandtech.com](http://www.anandtech.com)

Frequent in-depth reviews

[www.hardocp.com](http://www.hardocp.com)

Extreme overclocking

[www.tweak3d.com](http://www.tweak3d.com)

News, reviews and hardware tweaking guides

[www.firingsquad.com](http://www.firingsquad.com)

Games, hardware and Quake information

## CPU News

by Garry Wallis

### Don't underestimate Intel in the x86 game...

AMD's 7th Generation microprocessor, the K7 or Athlon, as it's now known, could seriously hurt Intel's high-end CPU market. The benchmark results that have been released at the time of writing put the Athlon clock for clock ahead of Intel's 6th generation Pentium III core.

Intel will not just sit around on their proverbial's and let AMD take away their CPU business. What have Intel got in store for us in the near future.

### CeleronA 500MHz

**Processor core:** 6th generation P6 (Mendocino)

**Slot type:** 370 PPGA

**Front side bus speed:** 66MHz

**L2 Cache:** 128KB Full speed on-die

**FAB process:** 0.25 microns

#### Comments

Intel has had wonderful success with the Celeron line of processors, especially with we gamers. I am sure that the 500MHz Celeron will not change that. This processor may not be as overclockable as previous Celerons. The clock multiplier is set at a high 7.5 times which means that only 75 and 83.3MHz system bus options are available. Even then 83.3MHz x 7.5 equals 624MHz which will probably be unobtainable for most overclockers.



600 MHz is as fast as a 'standard' P3 will run at. Until Coppermine, at least...

### Pentium III 600MHz

**Processor core:** 6th generation P6 (Katmai)

**Slot type:** Slot1 BX based

**Front side bus speed:** 100MHz

**L2 Cache:** 512KB Half speed on SEC

**FAB process:** 0.25 microns

#### Comments

AMD have released details of their Athlon processor running at 600MHz. Intel must release a processor at this speed to not seem like they are behind. The Pentium III 600MHz will be release sometime in August and will still be manufactured on a 0.25-micron processor like previous P3's. This processor offers nothing new over previous Pentium III's as only the clock speed has been increased. This is probably a stop gap solution so at least Intel have a processor on the market that is also running at 600MHz.

### Pentium III 533, 600MHz

**Processor core:** 6th generation P6 (coppermine)

**Slot type:** Slot1 BX and Camino based

**Front side bus speed:** 100MHz and 133MHz

**L2 Cache:** 256KB Full speed on-die

**FAB process:** 0.18 microns

#### Comments

This will be Intel's flagship processor and should hold up very well when compared to AMD's Athlon. The Coppermine processors are expected to ship

sometime in the 4th quarter of this year. The release will also include a new motherboard chipset known as Camino. This chipset will introduce a new RAM type known as DRDRAM or Direct Rambus DRAM. There has been considerable rumours on the Internet regarding possible problems with DRDRAM memory as more information surfaces we will keep you informed. We have been assured that Camino and Coppermine is still on track for release in Q4, let's hope so for Intel's sake.

### Williamette

**Processor core:** 7th generation P7

**Slot type:** SlotM

**Front side bus speed:** Unknown

**L2 Cache:** on-die, size unknown

**FAB process:** 0.18 microns

#### Comments

This processor will arrive sometime in the first half or the year 2000. Williamette will be Intel's first 7th generation processor. It will be massively superpipelined and will probably debut at around 1GHz. Little is still known about Williamette and as such speculation on actual speed can't be made. Although I am sure it will be as fast or faster than AMD's 7th generation Athlon processor.

#### Last word

I hope for Intel's sake that their Coppermine processor works out, from what we have seen of AMD's Athlon processor the Pentium III needs a face lift and soon. Intel of course will release their Pentium III at 600MHz and their Celeron at 500MHz but will this be enough to fend off the Athlon onslaught? Intel has great financial muscle and as such could probably hold out against AMD for some considerable time. I guess only time will tell.

## Processor availability table

Processor	Available	Architecture
K6-III 500MHz	Q3 1999	6th generation
CeleronA 500MHz	Q3 1999	6th generation
Athlon 600MHz	Now / August 1999 (in volume)	7th generation
Pentium III 600MHz	August 1999	6th generation
Williamette	1H 1999	7th generation

# ARE YOU HYPERACTIVE?

The all new and improved Hyperactive is here  
news previews review chat code download prizes



## hyperactive 3.0

GAMES ONLINE

▶ [HTTP://HYPERACTIVE.COM](http://HYPERACTIVE.COM) ◀



PLAYSTATION



MAC



PC-COROM

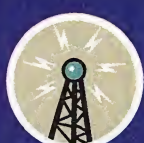

CHAT



SEGA



ARCADE



NINTENDO 64



## NET GAME NEWS

GEE-GOLLY GOSH EDITION.

## Nerf ArenaBlast

<http://www.vmisoft.com/>

Yes, ladies and gentlemen! First there was the announcement that Quake 3 Arena was in development, then Unreal Tournament. Even Acclaim are getting in the action with their next Turok release. The gaming industry are jumping on the multiplayer-only release wagon and riding it for all it's worth. And now, NGN, in the interest of breaking the latest and greatest news to hit the online gaming scene, take great pleasure in announcing the next multiplayer-only first person bonanza. The following press release statement says it all.

*"Nerf ArenaBlast combines the thrill of target competition with the bright colours and vivacity associated with Nerf toys."*

- Tom Dusenberry  
President, Hasbro Interactive

Nerf ArenaBlast uses the Unreal engine, and is set for a Christmas release.

Calmed down just yet? There's more. Nerf ArenaBlast will introduce revolutionary new styles of multiplayer.



Pointmatch is basic deathmatch with a twist - points are scored not only for "kills" but for connecting hits with other players. More points are scored for more sensitive parts of the body - like, for example, the head, torso and of course, nether-regions (which is an exact geographical location!). The winner is the one with the most points at the end of the match.

Arena Race has players race to be the first to touch 7 different flags in a particular order. If you get knocked out by another player along the way, you are restarted at the beginning of the course. Remind you of those vicious and lethal pre-school fun-hour games? Indeed it should.

Scavenger Hunt. This is where it gets a bit more challenging. There are 7 different coloured balls that the player must collect, each colour representing a point value. The player must then take the balls and shoot them into a goal littered around the level. Points are rewarded on the colour of the ball you bring home and the difficulty of reaching the goal itself (some are allegedly very hard to reach). The winner again, is the one with the most points.

Oh, and you don't exactly get to slaughter your opponents, or reduce them down into bite-size giblets. It's more of a polite "knocking the wind" out of 'em. Okay, so it's clear that this one is aimed at the more experientially challenged and may be a huge success since it takes one of the most basic gaming thrills and makes it palatable for the Morally Upstanding. Just don't be surprised if you see the NGN crew online once this baby is released raining plastic and foam destruction on unsuspecting opponents.

And no, it's not April. This is not a joke.



## QUICK POLL

In #38 we asked "After playing the Q3ATest, how promising does the Quake 3 Arena seem? Very, moderately, or hardly?"

We were flooded with emails on this contentious issue.

*"...it is unbelievable. I play it every chance I get and can't fault it at this stage. For me, the balance seems just about right..."*

- Owen Kelp, Email.

*"I was disappointed"*

- Kieran Doherty, Email.

*"Quake3 has lived greatly up to my expectations. It is the game my friends and I now play at LAN's instead of Quakez, Half life, etc."*

- Fatidicus, Email.

*"I thought after playing the test that the improvements, while looking great, are hardly revolutionary."*

-Kano, Email.

And that was just the tip of the iceberg. It seems gamers were expecting a little more from the Quake 3 Arena Test. While this is a fair enough call, perhaps it has been forgotten that the Quake 3 Arena Test is a hardware test ONLY. As the id team continue to reiterate, all gameplay issues, like weapon firing rates and speed, as well as character movement are not being dealt with in the test. Be sure though, that id are paying close attention to the christmas gamers are having with Q3ATest. So stay vocal!

This month we ask "Would you prefer to subscribe to an online gaming service like Wireplay or Multiplay, or do you prefer to rely on the Internet and free services like Gamespy or Boneyards to play online?"

Email your responses to [ngn@pcpowerplay.next.com.au](mailto:ngn@pcpowerplay.next.com.au). Results to be published in #42.



## TOP 5 MULTIPLAYER GAMES

1. Quake3Arena Test
2. Tribes
3. Aliens vs Predator
4. Descent 3
5. Everquest

Whether you're happy with it or not, it seems the Quake 3 Arena Test looks set to take over Quake and Quake 2 as the most popular online shooter of the moment. Even though it's far from complete and still has plenty of tweaking to go through, action fans have embraced id's latest offering with open arms. Tribes does the jump up again, perhaps with the recent announcement of Extreme and early information about the sequel slowly seeping across the 'Net. The newest entry is AvP. Although it has been released for some time now, it's only just now started to gain any real popularity online. Perhaps it took that long for gamers to get used to and comfortable with the tight controls in the game.

To cast your vote for the Top 5 Multiplayer Games every month, email [ngn@pcpowerplay.next.com.au](mailto:ngn@pcpowerplay.next.com.au) with your favourite online game.

## It's Your Turn

<http://www.itsyourturn.com/>

"Play online chess, checkers, backgammon, Battleship, Othello, Connect4, and more!"

This is the enticing call made on It's Your Turn's new massively multiplayer game service Web page. Allowing registered users to play up to 28 different (okay, some of them are bloody similar but they've got different names, right?) classic board games online using the Play By Email (PBEM) method.

That is, you take your turn, send your move to the other player via email, then sit back and await your opponents response. Games often take days, if not weeks.

Riveting stuff.

And if you're concerned that logging on the It's Your Turn web site will be somewhat of a lonely experience - think again. There are

**v-GO™**  
Universal Password

Download Free!  
Click here

- Welcome
- What's v-GO?
- Download!
- Help & FAQ
- About PassLogix
- Be an Affiliate!
- Press Room
- Contact Us
- Privacy Policy

AT&T WorldNet® Extra Members  
Click Here!

*"It's fun and incredibly simple."*  
- PC World Online

**passlogix™**

## Get v-GO

Never forget a password again!

**FREE!** v-GO remembers your user names and passwords and automatically logs you on to all your password-protected Web sites and applications. Works everywhere!

**EASY & FUN!** v-GO is the world's first graphical password! All you remember is one or more clicks on the animated Password Window of your choice. v-GO takes just a few minutes to download and set up. And the smart Instant Logon feature makes logging on fast and effortless!

**SECURE!** v-GO safely stores your user names and passwords in an encrypted file on your desktop so you control them. v-GO also locks your computer and protects files.

[Buy v-GO Plus!](#)
[Quick Tour](#)
[Send to a Friend](#)



The v-GO password interface screen. With tender loving care, you select your ingredients and place them in the pot, ready for the simmer. Each food stuff here represents a password... er what? Surely they can't be serious!

currently 330,000 games in progress at any one time. The sheer popularity of this site is mind blowing. If multiplaying classic board games whet's your whistle, check this one out as soon as you can!

## V-go Universal Password

<http://www.passlogix.com>

How many different passwords do you have to manage for your online escapades? These days, it's not uncommon for the average net gaming soul to have at least a dozen of 'em. Remembering them all consequently, becomes a bit of a nightmare.

V-go Universal Password by Pass Logix is a

neat little utility that combines any number of password strings into one manageable whole - a single password. Although an aged concept, its implementation has been hampered by an fairly hacker-friendly presentation.

Pass Logix have gotten around this by hiding the passwords in a simple graphic, which is, according to Pass Logix, extremely difficult to crack.

## ItsYourTurn.com

60 seconds a day is all it takes to CRUSH your opponents

Over 340,000 games started, over 65,000 registered users  
Sign up for the **July Main Tournament** by Tuesday, July 13  
New Games! Play **Pente** and **Stack 4x4** right now  
Sign up for a **Frequent Player Tournament** for Pente  
Sign up for a **Frequent Player Tournament** for Chess

Please Login

Please login:

Userid:

Password:

Forgot your password? No problem. [Click here](#)

New Users

**What? You don't have a userid?**  
That's OK, you can [create a new userid](#), and start playing **right now!** Go ahead, it's **FREE!**

Welcome!

Welcome to It's Your Turn, a unique concept in online games!

No Java! No downloads! Just pure, fast gaming enjoyment with thousands of human opponents. **WebTV** and set-top box compatible.

So what games are available? We feature **chess, checkers, backgammon, Battleship, Stack4** (our version of Connect4), reversi, Go-Moku, and variations galore.

What makes us so different from the other 200 billion game sites on the Internet?

**PLAY**  
[game status](#)  
[invite user to play](#)  
[find game](#)  
[join game](#)

**TALK**  
[my messages](#)  
[send message](#)  
[message board](#)

**SPY**  
[tournament area](#)  
[who is here?](#)  
[games in progress](#)  
[completed games](#)

**ACCOUNT**  
[update profile](#)

## Current Game Versions

Blood 2 - 2.1

Quake 2 - 3.21

Half-Life - 1.0.1.0

Quake3Arena Test - 1.05

Unreal - 2.25\*\*

Sin - 1.05

Shogo - 2.2

Starsiege Tribes - 1.05\*\*

\* changed in last month

### Essential Online Gaming Files

MPU - [www.mpu.com.au](http://www.mpu.com.au)

ACGP - [www.acpg.com.au](http://www.acpg.com.au)

Multiplay - [www.multiplay.com.au](http://www.multiplay.com.au)

Wireplay - [www.wireplay.com.au](http://www.wireplay.com.au)

mIRC - [www.mirc.co.uk](http://www.mirc.co.uk)

ICQ - [www.icq.com](http://www.icq.com)

Gamespy - <http://www.gamespy.com>

# Online RPG News

It's been an exciting – and controversial – month in the world of ORPGs. We've gotten wind of at least one new ORPG in development, with hints of more to be announced in the very new future. It's a good time to be an RPG enthusiast.

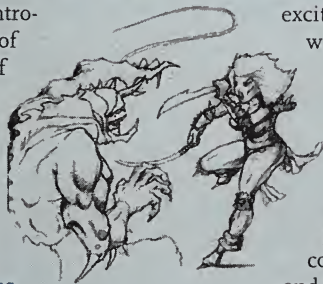

excited yet - Atriach is still a fair way from release.

## EverQuest

[www.everquest.com](http://www.everquest.com)

Race Wars are all the rage in EverQuest. Started on Rallos Zek server (the player versus player server), a collection of Dark Elves, Ogres and Trolls took up arms against almost everybody else. Verant and

989 Studios have decided to even up the fight a little, and are set to provide a whole new server dedicated to Race Wars. Expect a whole lot of carnage and mayhem as players release their pent up (non-pvp) rage.

A new patch has been put in place on the test server. This patch contains a number of minor fixes and enhances a number of magic spells. Broken spells (which are mostly high level) have been fixed, with a good many also enhanced to help balance the game further.

## Asheron's Call

[www.turbinegames.com/asherons-call/index.html](http://www.turbinegames.com/asherons-call/index.html)

The Beta 0 of Asheron's Call seems to be proceeding smoothly. Due to the NDA (Non Disclosure Agreement) requirement upon becoming a tester, the small number of testers in the Beta 0 are not allowed to release any detailed information regarding the specifics of the game. Word is though, the testers are mighty chuffed with what they're playing. Check out the above site for official news, or sites such as the Asheron's Call Vault (<http://www.acvault.com>) for more info.

## Atriarch

[www.atriarch.com](http://www.atriarch.com)

And they keep on coming. Atriach, developed by World Fusion, is a new sci-fi online RPG using the first person perspective. Set in the (huge) world of Atriana, an alien planet made up of a whole myriad of living entities, it is not like your typical fantasy ORPG. Firstly, a great emphasis is set on war, where a large faction and battle system has been planned allowing players to stage massive campaigns against rival factions. With the option to utilise software or hardware acceleration, it should also look quite spectacular indeed. Other features, such as the ability to reproduce, or construct cities, are set to make this game one of the best in the genre. Just don't get too

## Ultima Online

[www.owo.com](http://www.owo.com)

It's been a controversial last few weeks in Sosaria. OSI's recent "No Holds Barred" approach to harassment and macroing has left a lot of people scratching their heads. If



you are caught taking part in unattended macroing (which can be done using third party programs, or a simple piece of paper wedged between keys while you bugger off and do something else a little more useful), whether it is fishing or practicing Anatomy on an NPC in your house, you are automatically banned – permanently. This has left many people understandably angry, as it is quite hard to be a formidable and built up character without some form of macroing. Harassment policies within UO have also changed dramatically. It seems that now, at a Game Masters discretion, you can be permanently banned for using mild expletives and seemingly harmless slang. What makes this even more interesting is that you can be talking to close friends, or guild mates, when no one else is around, and still get banned. Expect a patch soon that deals with this Origin Big Brother policy. While we're fully aware that Origin need to address certain issues when it comes to co-existence within the game, there is a point where things have gone too far. For a company that failed to act upon the excessive player killing (especially of newer, less powerful characters) prevalent soon after the game's official release in the name of total freedom, it's hard not to agree that having an affectionate spar of words with your guildmate behind closed doors is nobody else's business. Especially not Origin's.

Lindsey Smith

## Online Racing News

Gentlemen start your engines!

### Toca 2 Professional Championship

Like a bit of Toca2? If you are interested in chasing down the AI and seeing how well you stacked up against others that have attempted the same course, offline racing is for you. There is a myriad of sites dedicated to offline racing on the net and one of them is Toca2 Professional Championship at <http://blitzports.com/racing/leagues/toca>. This site is actually run by an Australian by the name of Sam Castelli. Sam is very dedicated when it comes to racing simulations and it shows in the professional way he runs his league. At the moment there is a series running with the winner receiving a Thomas Enterprise steering wheel valued at over \$600.

### Le Mans 24 Hours

<http://www.lemans-game.com>

LeMans 24 Hour is a racing simulator on the horizon that we just can't wait to get our hands on. Kev the PR Manager at Eutechnyx seem to think their racing sim is going to rule the roost (It'll take a lot to knock off TOCA 2 - Ed.).

"Although Le Mans 24 Hours features a quick-start Arcade mode, the game IS a racing simulator.

We went to great lengths to ensure that the game was as realistic and accurate as possible. For example, every team was given a SIXTY question form that was used to create



the driving profile for their car; we photographed every single inch of the Le Mans circuit to ensure it was as visually accurate as possible and we even had representatives of the ACO (the race organizers) come over to "drive" around the virtual track to ensure it was correct.

This attention to detail, combined with the highly advanced physics model we've developed make Le Mans 24 Hours one of the most accurate and realistic racing games ever," said PR manager of Eutechnyx, Kevin.

PR spiel aside, this is one racing game to look out for. With the dedication to realism a top priority, Eutechnyx are also working on a solid multiplayer engine to ensure this one is adopted by the racing masses. We wait patiently.

### GT Insider

<http://scgt.sports-gaming.com>

A new twist has arrived in the way of how offline-racing results are brought to you. The guys over at GT Insider are hosting a radio show, with results reported via RealPlayer G2. After listening to the show you might be fooled into believing they are reporting on an actual multiplayer race! With quotes from winners and how they fared during a recent race in their series that is still in progress. It's also a very good site for anything you may need for Sports Car GT, in the way of patches, support files and links.



### Dukes of Hazzard

<http://www2.southpeak.com/games/dukes-racing/default.htm>

Throw the moonshine in the boot and look out for the Boss Hog. Yes the TV series is now coming to you via the PC.

Bugger the nostalgia - this game is exactly what the racing genre (and especially online racing) needs. A respectable racing engine with an emphasis on rally-style hooning, with stunts and jumps thrown in for good measure.

The General Lee is coming. Start practicing those thick Southern accents now!

Phill "Carnrat" Bennett







# LETTERS

Write to PC PowerPlay  
LETTERS  
78 Renwick St  
REDFERN, NSW 2016  
letters@pcpowerplay.next.com.au

## Gaming grrls

I write this letter to you in what I believe could be the biggest scourge on PC gaming yet. Girl gamers aren't a majority but they are influencing software house's marketing guys so we see games like Sabrina the Witch and Barbie being released. I personally believe games like that are a waste of coders' time and are insulting to all male gamers.

EA sports have also just announced that they will be making a Michelle Kwan Championship Figure Skating game. How crap it will be. The worst thing of all is that EA will be wasting money and talent on that crap when they could invest it in a worthwhile venture. I bet there are many poor guys out there struggling to get their game made. I'm not sexist, I'm just stating the fact that big game companies do market research and if they see a girl gaming trend they will start making more female orientated tripe. So please guys out there don't introduce your sisters, girlfriends, mothers to the world of computer gaming or you'll be damning us all to half-baked girly games.

### Selvo Internet

*Surely no one is actually forcing you buy these "girly games"? So much money is wasted in the gaming industry already, we hardly think it fair to lay the blame solely at the feet of a fairly small segment of the marketplace. On the other hand, many grrl gamers would no doubt be equally insulted by the lame Barbie and dating game atrocities that have been released in recent times. If for entirely different reasons, of course...*

## Grrl Gamers - the sequel

Can anyone tell me why there seems to be two categories for games these days: 1) Games, and 2) "Software for Girls", and incidentally, is this stuff actually considered entertainment? I ask this as recently I saw an entire display of Barbie software at my local store. You can now cut Barbie's hair, do her make up, design her clothes, co-ordinate her wardrobe and make "fun" stationery too! Whooppeee! Everything a growing girl needs.

I think what I'm trying to say is that marketing in this way seems to be taking a giant leap backwards for making games a more female friendly pastime. Instead of making it fun for all and all for fun, it's almost saying pink's a girl's colour and boys play Doom. We now have Lara, and heaps of female skins in a range of games from Quake to Ultima Online. These titles suggest, hey, there's room for everyone in here. Still, we are seeing an ever increasing amount of "Software for Girls" out on our shelves.

**Zelda  
Paddington, NSW**  
*Girls playing Quake? Heavens! Whatever next?*



Another Paul Steed masterpiece - one of the female models for Quake 3. Dig the red leather pants!

## Easy Violence

Let it be made clear, I am not one of those people who feel that violence in computer games begets violence in the real world. I do however find it a concern that the PC games industry relies on violence to keep it going. It was one of those shock revelations you have, but look at all the FPS, RTS and War sims - these are all games that rely on

violence. Even the humble old RPG has battle tightly integrated in it.

So once you look at it it's probably at least 3/4 of all games produced that rely on violence, if

not more. That's a lot and why is this so? Because it is much easier to make a good violent game than a bad non-violent one. On the whole to be without violence a game has to be about business or sports, have a good story or be one of those puzzle games. Story based games, like adventures, have limited replayability since they, of course, involve a story and once you know the story you know the game. Some puzzle games have the same problem.

So we are left with violent games with their great versatility - multiplayer, level editing, mods, TCs, etc, etc. And to think there still isn't an R rating for games in Australia.

**Waza  
Internet**

## Mac Dumping

In regards to the MacArena letter in #38, I agree with some of what Ethan Watson says. id is a great company, dedicated to bringing fine games to a variety of platforms. The Mac is also a viable gaming platform, but so is a Commodore 64 (Really? We'd better retrieve ours from the rubbish tip then - Ed).

As a designer, I have used Macs for well over 5 years and had high hopes of them attaining the mantle of games machine. Alas my faith bought me nothing. Why I hear you ask?

1) OpenGL has only just been released in the latest version of MacOS, so prior to this, there was no hope of any 3D acceleration in games short of crappy QuickDraw rendering. They have also lost in 3D production stakes due to this, as hardly any professional 3D programs run on Mac.

2) After rumours of price drops, you still have to pay \$6000 for a G3 without a monitor. For that price, you could buy two high end PCs WITH monitors. You make the choice.

3) Admittedly the latest G3's will accept PC-100 RAM, but if you want to tweak and test new hardware, not a chance. Try finding a throttle and pedal setup for a Mac, or drivers for a TNT2.

4) If they were serious about the Mac being a games machine they wouldn't have released such a stupid mouse and compact keyboard. Sure they look cool, but do they function? And why no floppy disk?

5) True the MacOS may be easier to use and more automated, but this leads to idiot syndrome. So when your Mac does kick the bucket, you will be stuck with a sad Mac icon and no idea of what went wrong. In fact, the usual solution to any Mac problem is reinstall the system. At least PCs have Safe-Mode.

So all of a sudden, Steve Jobs and the Mac world, after all their elitism, suddenly pop up with five funky new flavours mumbling something about a "games machine", we should listen?

Maybe I should Think Different I suppose...

**Gabriel  
Email**

*There you go readers, all in point form. And that'll be the last of the hoary PC vs Mac debate, wethinks.*

## Point and Shoot

What is wrong with today's games? They're not providing any entertainment for me. I walk into a PC shop and I look on the shelves and see games like Duke Nukem 3D, Quake and games like that which require none or little brain usage. RUN SHOOT RUN RUN SHOOT SHOOT RUN RUN RUN SHOOT SHOOT and so on. Now what is the point of games like this? In Geraldton W.A these types of games are being sold at up to \$90 - talk about a rip off! For \$90 I expect an extremely good game,



**JOLT COLA LETTER OF THE MONTH**  
A CASE OF THE GOOD STUFF FOR THE LETTER  
THAT SAYS IT BEST

## Indecision

I sat down and thought to myself, I'm going to write a creative, inspired, intelligent and topical letter to PCPP to give myself a chance of winning the box of cola, but then I realised I was a stupid mundane in-eloquent nerd who would much rather be playing Quake 2 online than squabbling over pretentious self-righteous issues. I think all letter writers should consider this before putting finger to keyboard.

So thank you for your time.

**Ryan Hallman  
Email**

*Need we say anymore, readers?*

not one where you hold a gun up for hours on end in a dark place and shoot the crap out of anything you see.

I have been flooded in at my place for a week now and I have been playing the same game - Quake - over and over. It just didn't do nothing for me (It can't be too bad if you played it for a week - Ed).

I reckon today's games better get off the track of running and shooting and get back to reality because if it doesn't the world's games are only gonna go down further.

**James Gould**

**Email**

*Many people share and understand your pain, James. That's why games like Half-Life and Thief have been so immensely popular. Not to mention the dozen or so games released a month that have nothing to with RUN-SHOOT-RUN-RUN-SHOOT'ing. Give some of them a try.*

*It sounds like your local games store is woefully stocked - go with a great mail order service to get the latest and greatest. Games have come a long way since Quake and Duke Nukem 3D.*

## Your local dealer

In the May issue, Jim asked how many gamers buy Gateway or Dell systems.

As I own a Dell (and a lovely one at that) and consider myself a gamer, I decided to stand up for it. Compared to other systems that I looked at (over the period of half a year and over 24 quotes from different companies) I decided that Dell offered the best. In November last year, how many of you could buy a 333 Celeron with 128MB RAM, 10 GB HDD, 19" Monitor, 40X CD-ROM, etc for about \$3500? Let me take a guess. None if you didn't look to Dell.

Although the video card was a bit slow for a game machine (ATI Rage Pro), that was easily upgraded to a 16MB Banshee. Plus, after finding something wrong with the monitor a few months after the purchase, they replaced it with hardly any questions asked, to my door the following day. Can you expect that from your local dealer?

In case you're wondering, I don't work for Dell...

**Ian Clark**

**Email**



## I know

I know you won't print this letter but I was wondering how many letters you trash that start with "I know you won't print this letter"?

Regards

**Stuart**

**Email**

*Too many, but there are always exceptions.*

## LEBs

An apology on behalf of all LEBs. I would like to apologise to all non-LEBs out there in the gaming world. You may be wondering what exactly a LEB may be. A LEB is a Low End Bastard. Quite the opposite to a Low Ping Bastard (LPB). A LEB is one of those guys who ruins a LAN and has every one playing Pacman with a 200 ping because of their low end machine, just so they can play. The latest game on my desktop sized laptop is Prince Of Persia which is a bastard to play because it's bloody hard to distinguish between health and poison on a monochrome screen.

Therefore I classify as a LEB. LEBs are always at least 100MHz behind the standard. To us LEBs, the standard is merely a theoretical speed of computer that is impossible to attain but is good to dream about none the less.

So, my sincerest apologies to all

non-LEBs, but hey, look on the bright side of things - at least we don't have Macs!

**Damien Donnelly**

**Email**

*But - hey - isn't Prince Of Persia a fantastic game.*

## Game Moralists

Games are a temporary escape from the real world. We gamers get our fun from them, and leave it at that. We don't play them and think that we are instantly able to go down the road and blow the crap out of someone with an MP5-SP! I hate people who go on and on about how games should have morals and some true meaning to life behind them. What a load of crap! Games were made to be fun, and they are. That is why they are called games. Just because I get happy by running people over in Carmageddon or GTA, or I like to shoot innocent civilians in Blood 2, doesn't mean that I will do it in real life. I found Blood to be quite comical, and I think many other people do too. Not one person I know takes it seriously.

We're not Americans. Do you see people in Australian schools having deathmatches? To all those people complaining about violence in games, and crap like that - get a life! Besides, why the hell should we gamers suffer because of one or

two arrogant people?

**Nik Pataky**

**Email**

## Game moralists - the sequel

I'm writing to you (as opposed to sending a telegram, making smoke signals or just shouting very loudly indeed, for which I'm sure you're ecstatically grateful) in response to the letter by Adam South in Powerplay #38, headed "Gaming Morality". Reluctant as I am to take up the suggestions of the criminally deranged and so, as the man himself proposed, donate a white coat to his wardrobe and deposit his clueless body in a square room furnished only with comfortably padded walls, I feel I must vent my anger in forcibly disagreeing with his simple-minded argument.

Adam, you're a complete tool. "Gamers play games for fun and entertainment", you say. Since when were you appointed spokesman for the entire gaming world?! When did we grant you permission to voice your own self-important opinions and neglect those felt by the rest of us?! Never - that's when!

Personally, I play games for enjoyment, but that enjoyment comes in many different guises. Sometimes it comes from escaping to another world (Baldur's Gate),

...man... wardrobe and depe...  
...room furnished only with...  
...I must vent my anger...



Thalantyr: Typical, just typical. Sooner or later we just HAD to find a room with a big mystic bloody crystal.

sometimes it comes from being scared out of my mind (Half-Life), sometimes it comes from laughing til my jaw aches (Grim Fandango) and, yes, sometimes it comes from thinking about the events happening in the game and even learning something. In this last category, there are plenty of games that have made me respond like that. In particular, I want to mention the Ultima games which have always had a deep storyline that examined issues affecting the real world, like racism, poverty, corruption, morality and religion.

Just as people watch different sorts of films for different reasons (action films for the special effects, dramas to cry or feel moved, Star Wars for a good laugh, arty French flicks for naked girls, etc), I and I'm sure many others do the same with games. Final Fantasy 7 was so good because it had all these elements in the one game. It made me laugh and cry and think.

You can speak for yourself, Adam, but don't think you can speak for everyone.

**Lara Croft's Left Nipple**  
**Email**

*We're impressed. A real, actual, live debate in the Letters page. Keep 'em coming, people!*

**5th level butt booters**

Imagine it is 4 am on a gloomy

Wednesday. You have been wandering up and down the Sword Coast for 58 days now, game time that is, killing and conquering to your heart's content, and proud you are of your many achievements. You've cleared the mines, saved the halflings and farmers from bandit and demi-human peril, and just now you've hooked up with some elf dude and trounced a pair of Wyverns. What glory! What triumph!

With your one free hand, the other gripping your mou-er, sword, you quickly load in CD 4 of 5 (Baldur's Gate's one annoying feature- the constant necessity of switching discs) and head off to the Gnoll Stronghold where your brain-damaged, hamster-loving ranger will slay the smelly beasts and save the damsel in distress.

This should be easy, you think, my characters are 5th level butt booters, I have slain ogres and wizards, a castle full of grunting hyena-men will be a cakewalk. So you tramp through the mountain pass, trouncing a few Winter Wolves along the way, and finally you arrive at the walls of the Keep. There you wait, fingers twitching, eyes smarting, as the new area loads in. The loading bar fills up, the red eyes glow in the grinning skull which indicates completion, you suck in a sharp breath... then nothing. Absolutely nothing. The

screen is completely frozen. No, you cry. No! No! NOOO! Thwarted again by this foul machine!

Does this sound familiar? I have had my computer for a few months now, I use it almost exclusively for gaming. It is an AMD 350, and I can't figure what is going wrong. It always works just fine until crucial moments in my favourite games. So far, this means if I ask someone more learned about computers than myself what the problem might be, the response is 'It seems to be working fine'. Is it the machine itself? Are AMD processors just fundamentally screwed? Or is it my beloved Black Isle Studios who are to blame? I am a dedicated gamer, but I know precious little about effective troubleshooting beyond reloading the drivers or O/S. Is it just me, or do we all suffer from a plethora of niggling problems when buying a new system?

**S. McJohnson**  
**Email**

*It's a little known fact but AMD actually stands for Anti-McJohnson Device. Put simply, you are fundamentally screwed.*

**Dark and scary**

Hey, love the mag, you guys are doing an awesome job, but I have a question for you. I've noticed a trend that has started happening during the last couple of issues, it began

with the review of Thief: The Dark Project (awesome game, by the way!) you guys did in February. The screenshots were all so dark, I could hardly see anything! This disease then went on to infect the Heretic 2 review (another awesome game!), the Thief and Quake 2 playguides, and even last issue it seemed to get worse with Requiem and Wages Of Sin! I've already spent thousands of dollars on retinal surgery because I thought it was my own eyes that had the problem, but now I've had enough. (Just kidding...)

So what's the real problem? The disease seems to mainly affect 3D accelerated games but then others like Descent 3 and Rollcage in the same issues look alright. What the f&#% is going on? Do none of you guys know how to adjust the gamma correction in these games? How hard can it be to make them the games look brighter, like how they are when you actually see them running on your PC. Please fix this problem before I go blind from all the squinting I have to do to read your great mag.

**Joe**  
**Email**

*Aside from the fact that these games are naturally quite dark (game developers would prefer to call it 'atmosphere'), screenshots do tend to lose a good deal of colour when they are converted from the back-lit RGB of a monitor to the print standard CMYK. Add to this the sometimes erratic colour variations inherent in long run printing - the amount of ink on the presses is more at the start of printing and hence things tend to be darker. There, clear as mud? Or should that be clear as a Thief grab...*

**The Last Word**

In his July editorial, Mr Ben Mansill, the esteemed editor of your authoritative organ, made mention of what he perceived to be a defining moment for many gamers. That is, seeing Quake running under 3D acceleration.

Perchance you will allow me the indulgence of disagreeing? Without a shadow of a doubt, the only comparable moment I myself have experienced came from loading up the latest edition of the Complete Oxford Dictionary CD ROM. It defined everything for me!

**Smartarse**  
**Email**

*Quick! Nurse! Another one has escaped!*



\*nothing on this page is true. please don't sue

## Ask Abe...

In his regular column, everyone's favourite Mudokon and Oddworld inhabitant will endeavour each month to solve all your gaming related concerns. A philosopher of great renown, Abe can also draw upon many years of first-hand experience at the forefront of the games industry. So, if you have a burning question, then just Ask Abe...  
 Sylvester Rowbotham of Launceston, Tasmania writes: "I must put pen to paper to express my dismay with the declining state of the Ask Abe column. What began, all those years ago, as a vital and insightful contribution to mankind's collective store of knowledge, has since been reduced to a series of paltry, hastily-cobbled together and patently unfunny in-jokes. I remember when I was but a kid, running to the newsagent through sleet and snow to gaze reverently upon your newest enlightening revelation. Now, quite frankly, I could care less."  
 Abe: "Get me outta here!"

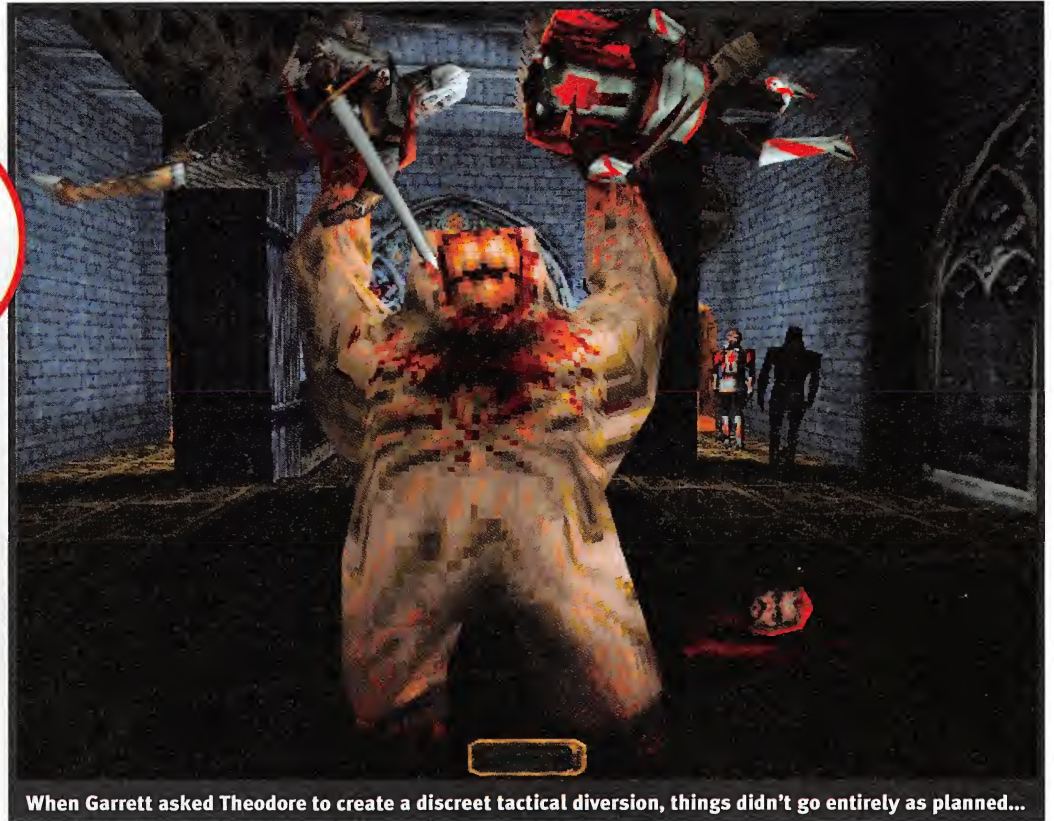

When Garrett asked Theodore to create a discreet tactical diversion, things didn't go entirely as planned...

## PC VS. PLAYSTATION: PC-1, PSX-0

Over the years we've been sent some damn cool, and always completely useless promotional things. But the moment this baby arrived from Cavedog, we knew we had a winner. Unfortunately they sent only one, which meant that Team PowerPlay held siege against the scum of the Playstation mags, who, it must be said, threw themselves against our steely rampart with impressively lax regard for life and limb. When Unofficial Playstation Mag's Hillous Lesslie burst

through our defenses and crashtackled PCPP Ed Ben, we knew it was all over, but by the lords we took a few of them with us!

The next day, after a night of extensive work in the PCPP Weapons Research Lab, our extra-high tensile version, boosted with 3 additional rubber bands for unparralled stopping power, made its debut. Respectful of our co-workers lives, we conducted a public test firing, so as to demonstrate the city-shattering capability of our new device. Hoping to subdue our foes with this live ammo test, we punched a fingernail-sized hole in the plasterboard office wall at a range of 60 feet!

A war won with no casualties is a shallow war indeed, but we'll take any win we can. The Playstation Army have been suspiciously quiet of late, with reports of late night experimentation with their Nerf Bazooka and large amounts of fibreglass resin. We have our own secret weapon in progress though, as always, PC will win over Playstation every time!



## Knights filled with Dancing

Fans of epic RPG Might & Magic VII should rejoice with the imminent debut release in a hopefully lengthy series of Aerobics videos. The first, entitled Disco Knights, features an anonymous castle guard to instruct you in the more physically demanding aspects of the game's Body Building skill. We now present you with a sneak preview.

# A TRIBUTE TO LucasArts

1990 - 1993

LucasArts holds a very important position in PC gaming history. More importantly, for this gamer anyway, is the LucasArts contribution to adventure gaming. For a number years in the early nineties, LucasArts almost single handedly represented this genre. They produced distinctive titles that combined an innovative emphasis on puzzle solving and humour with a user friendly interface, namely the SCUMM system. Some of these games from LucasArts' early era include Monkey Island 1 & 2, Day of the Tentacle and Sam & Max Hit the Road. Strap your adventuring rears in for a tribute to some of the greatest moments of LucasArts!

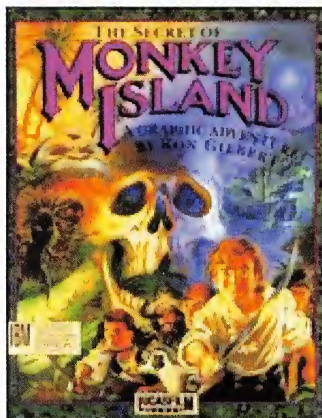

## The Secret of Monkey Island

Publisher: Lucasfilm Games  
Released: 1990  
Required: 286, 640K RAM,  
PC Speaker, Roland, AdLib.

A success story from three years earlier, Maniac Mansion had made an impression with the gaming public, particularly with its appearance on the NES but nothing would prepare the gaming world for an all out assault on hallowed ground. Adventure gaming at this time was still very much akin to its RPG origins and comedy as a feature in this type of gaming was uncharted territory.



The Secret of Monkey Island wasn't just an adventure game, it was a parody of an adventure game. Complete with a bumbling hero/anti-hero, Guybrush Threepwood, a decidedly troublesome damsel in distress, Elaine Marley, and an evil ghost pirate, LeChuck, this was an epic tale of silliness, swordplay and smart asides. Some of the most memorable comedy moments of this Monkey Island are the vegetarian can-

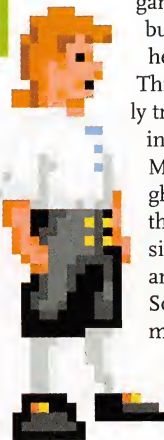

nibals and the used boat salesman. If you listen to the disciples, Monkey Island is the definitive LucasArts adventure title. The SCUMM game engine was LucasArts' modus operandi for this period and its influence can still be seen in The Dig from 1995. The interface was extraordinary for the time. So extraordinary, it changed little in three years and was the basis of many adventure gaming interfaces, for LucasArts and their imitators. A cursor was dragged around the screen and the names of objects that could be used came up with a default verb. For the first time, the game

gave you a little help in entering commands - so you could get on with the puzzle, rather than butting your head against the interface. This was a quantum leap away from the typing-in-commands tomfoolery of previous adventure titles around at the time (King's Quest comes to mind).

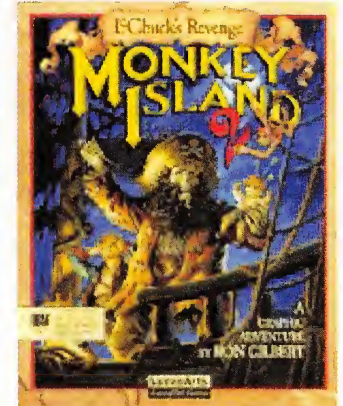

## Monkey Island 2: LeChucks Revenge

Publisher: Lucasfilm Games  
Released: 1992  
Required: 286, 256 color VGA,  
640KRAM  
Recommended: Mouse  
Sound support: AdLib, Sound  
Blaster, Roland.

Monkey Island 2 was released only two years later, so you could imagine that it would have been an almost identical retread. Not so! In fact, the game enjoyed a complete overhaul. The back-

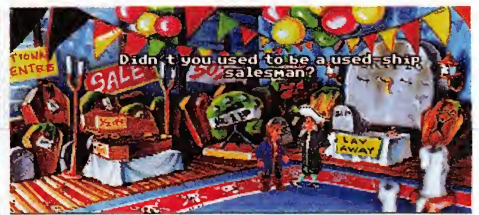

grounds of the game were now scanned from hand-drawn originals and you can really see the difference. A nice result of this is the more stylised look of the game that continued in other Lucasarts games like Day of the Tentacle. Other happy improvements include cutscene animation that we are so familiar with today as well as improved character animation.

Monkey Island 2 again features non-linear gameplay to keep the action interesting. If you can't solve a puzzle, you can wander off and talk to someone else and hopefully stumble across a solution (a common way of solving the wacked out puzzles of Monkey Island!). The spreading out of the gameplay is a feature that runs throughout Lucasarts games, even to the present. We also see icons replace the titles of items on your inventory. MI2 was a true successor to the original



and I think the superior adventure title.

One of the most ingenious features of Monkey Island 2 is the nature of the story. If memory serves, most of the game is Guybrush retelling the game's events to Elaine as he hangs above a big pit!

A cute result is that if you happen to die (I think only possible in one situation), the scene switches to our suspended Guybrush, who says "wait a minute, that didn't happen. So anyway..." and you return to that particular puzzle.

The end in itself is a most ingenious finale! I won't spoil it but no doubt somewhere on the Web there is the whole story for you... You should really pick it up and play it (again) anyway! The most recent instalment - the Curse of Monkey Island continued the comic tradition of the series, this time with swisher graphics. It is a fantastic game (92% PCPP #21) and won't look as dated as either of the earlier games.



### Indiana Jones and the Fate of Atlantis

Publisher: Lucasfilm Games  
Released: 1992  
Required: 286, 4 MB RAM, 256 color  
VGA  
Sound support: Adlib, Sound Blaster, Roland

This is a departure from the rest of the games featured here - the Fate of Atlantis cannot be considered a comedy. There is the occasional in-joke or comic event, but in general this is straight ahead fedora and whip wielding adventure. While this may have put off many gamers, the Fate of Atlantis was a good game that gave you the goods, much like the more recent The Dig.

In contrast to an earlier Lucasarts title, Indiana Jones And

the Last Crusade, which looks a lot like Maniac Mansion, this new Indiana Jones adventure is not a straight conversion of a film script. Thus, the designers had the freedom to introduce new characters and new locations and to tailor the narrative more particularly to a PC adventure game setting. And adventuring it was, with destinations such as North Africa, the Mediterranean and the ill-fated sunken city of Atlantis.

The engine is pretty much the same as Monkey Island 2, there being no real noticeable difference. The distinctions arise then from the style of play. In this game, you had to be more careful because, in keeping with the danger of the films, Indiana can die. There was naturally more of an emphasis on action as a means of progression through the game. A nice innovation was the distinctive "paths" you could take in the game: you could play it with brawn, brains or team.

This offered different ways to play the game: either with more action sequences, more puzzles or more dialogue.

Often times, you wouldn't know which was which, but this gave you the chance to come back and try certain situations a different way.

The rumours about a new Indiana Jones feature film had been all but crushed by Harrison Ford's refusal to play Indy again. This has paved the way for more Indiana Jones games that are independent of films. And considering the fias-





is an evil li'l blighter who one day drinks some nasty toxic waste, making him a diabolical mastermind, and soon enjoys world domination.

Bernard (from Maniac Mansion) is drawn in, together with friends, Laverne and Hoagie, to save the world. Dr. Edison agrees to transport the three heroes back in time to stop the events from occurring. Something goes wrong (but doesn't it always, natch) - Hoagie is thrown 200 years into the

past, Laverne 200 years into the future, while Bernard remains in the present with the mad doctor. It is now your responsibility to right the wrongs that have been done...

Day of the Tentacle featured three characters that you could select at any time throughout the game. You needed to pool the resources of the mansion over 400 years to complete the quest. A nice touch was the ability to pass objects through time via the Cron-O-John, a time machine toilet



co that was the Phantom Menace game, keeping away from film conversions seems a good thing (at least for the gamers, that is). We are eagerly waiting the newest Lucasarts Indiana Jones title: Indiana Jones and the Infernal Machine. Let them take their time though, since it looks to be more of a Tomb

Raider title. We can only hope that the developers look back seven years and see how it was done properly.

### John's Cream of the Crop

This is it. We're coming to the big ones. Day of the Tentacle and Sam & Max Hit the Road are, in my humble opinion, the pinnacle of Lucasarts adventure gaming. Combining wicked humour, troublesome ingenious puzzles and awesome visuals and music, these games offered entertainment above all else. Some thought they were too easy but isn't enjoyment far more important? What fun is a game like this if you don't get a hernia from it? It wasn't is if they were too short (like the regrettable Full Throttle). Apart from that they feature interesting, engaging storylines and hilarious characters.

So, without further ado, the lifetime achievement award goes to.... Oh wait! It's a tie! Put your hands together for...

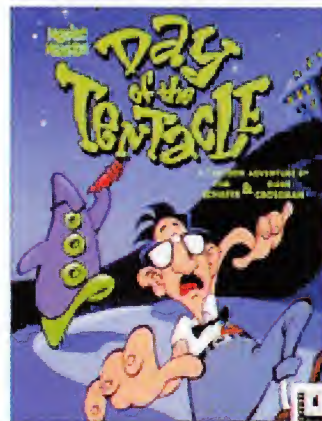

## Day of the Tentacle

Publisher: LucasArts  
Released: 1993  
Required: 286, 256 color VGA  
Sound support: AdLib, Sound Blaster, Roland and General MIDI

Day of the Tentacle was a sequel to the positively ancient (even in 1993!) Maniac Mansion. If you'd been gaming that long you'd return to the mansion of Dr. Edison for more shenanigans. This time around there are problems with some pesky tentacles. Purple Tentacle







(grrr...). Some of the inventive solutions required was the sewing of a tentacle costume for Laverne in the future (where humans are the slaves of the tentacles!) with a sewing machine in the past. Also the fact that Hoogie gets to interact with the forefathers of United States history and meet Thomas Edison, distant relative of the present day's Dr. Edison. It all added up to some ingenious and satisfying gameplay.

The animation generally was so wacky and cool that it'd be hard to find its match even today for clever art design. From the idle animations of the characters (burping, scratching and nose-picking) to the crazy solutions of the various puzzles, Day of the Tentacle was a winner and easily a match for anything that Lucasarts had made up until then.

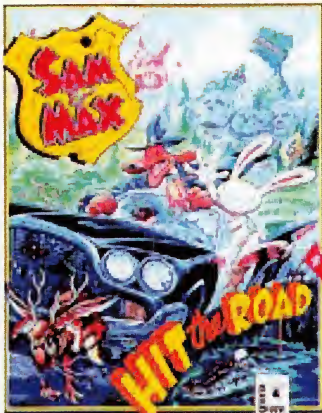

## Sam & Max Hit the Road

Released: 1993  
 Required: 286, 256 color VGA  
 Sound support: AdLib, SoundBlaster, Roland, General MIDI

Sam & Max began as comic book characters of Lucasarts employee Steve Purcell and have risen from making cameos in many Lucasarts games to their own game and a Fox cartoon series (which has incidentally



fallen into hard times...). Sam is the dog (canine shamus) and Max is the rabbit (psychotic nut job, more like) and together they solve crimes.

Sam & Max hit the road in 1993 (tee hee) on the trail of a big-foot who had escaped from a carnival and apparently kidnapped a giraffe-necked woman. The plot's always thicker than that though and before the end involving big-foot destiny arrives, you'll run into a Southern fried wretch named Conroy Bumpus. As Sam, with Max in tow, you travelled around various locations in the U.S.A following leads to solving the case.

Once again Lucasarts wheeled out the now elderly but improved SCUMM system. This time with the nice addition of a full-screen play area. The pointer of your mouse was itself animated and you had the option of cycling through actions to perform in the game. The icon would change when an action was pos-

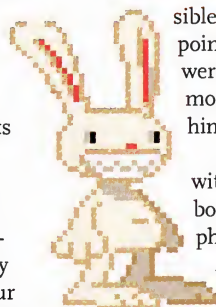

sible with what you were pointing at. Inventory items were available but often the most useful thing was Max himself - he's very resilient.

Super hilarity ensued with the (almost) hard-boiled detective atmosphere and piss-take on American culture both causes for celebration.

The game is full of priceless moments: the Cone of Tragedy, the World's Largest Ball of String and the making of a bigfoot costume. The game was

full of bonus mini-games: Wak-A-Rat, Car Bomb (a version of Battleship), Sam & Max Dress-up and the shooting game that ran over the end credits.

### Has Adventure Gaming Lost Its Way?

As much as it seems like the great titles of this genre are in the past, there have always been only a handful of great adventure games around. Playing these older games now is a good nostalgia kick, but there are plenty of new ones around to satisfy your appetite. Try Curse of Monkey Island. Or even better, Grim Fandango, a dark and subtle adventure with comedy elements and a soul as well - it's Monkey Island grown up. I don't believe adventure games will disappear anytime soon. They've come via some pretty impressive places. Viva Lucasarts!

John Dewhurst



## MIKE STEWART'S PRO BODYBOARDING

6 COPIES OF THE GAME  
\*INCLUDING AUTOGRAPHED COPY

We don't swim, here at PCPP. Our pale bodies shake with fear at the mere thought of immersion in cool, flowing water. What a silly concept! Having all that outdoorsey stuff simulated on a PC is much more elegant and civilized. All hail Mike Stewart for agreeing to allow his name on the box of the product that will further revolutionise our lifestyle.

**Q. What is the name of the Hawaiian nobleman that allegedly invented surfing?**

## TOTAL ANNIHILATION: KINGDOMS

6 COPIES OF THE GAME

Back in the olden days, before we had 100-ton Mechwarriors, 50-megaton thermonuclear weapons and Mach 5 supercruising Air Dominance Fighters, when war was waged it largely involved getting close to your enemy and trying to either stick something into him, or cutting some bit off him.

Gruesome stuff, but strangely appealing. Like this here new game, do read the review, please?

**Q. Who played Genghis Khan in 'Bill and Ted's Excellent Adventure'?**



## HEAVY GEAR 2

6 COPIES OF THE GAME

Great stomping things: The Game. Activision's 'Gear' series is into Mk II with this most excellent sequel. This is the future of war, you see, where design practicality is sent fleeing in the face of the really important factor - what looks cool.

The game looks cool, way cool. Plays a treat too, nice one Activision!

**Q. Which American President initiated the 'Star Wars' defence program?**

## SHADOWMAN

6 COPIES OF THE GAME

There's a lot of hype surrounding this game. Here's more: Shadowman is a dark and sinister scary adventure game designed with mature, adult players in mind. It's tops and it's almost here. Hopefully the game will be released by the time we draw winners for this competition, eh?

**Q. In what country does 'Voodoo Magic' have its origins, and is still practised?**

### WHERE TO SEND

Write the answer, along with your name and address on the back of an envelope.

Tip: Don't forget to put the competition name on the front of the envelope.

All entries close

September 12th. Send to:

<competition name>

PC PowerPlay

78 Renwick St

Redfern NSW 2016

### MACHINES

Q. What is another name for 'machine' code?

A. Binary, Assembly or Hexadecimal.

C. Avery, Robertson NSW

R. Royle, Willaston SA

D. Hewson, Kiara WA

N. Wegener, Freeling SA

D. Bos, Roseworthy SA

J. Pace, Airport West VIC

### EA'S CRICKET '99

Q. Earlier this year Ricky Ponting visited the Bourbon and Beefsteak bar at Kings Cross, when he left, was it his left or right eye that was a shade darker?

A. It was his left eye.

GRAND PRIZE;

T. John, East Keilor VIC

RUNNERS UP;

J. Townsend, Annerley QLD

D. Mutton, Morphett Vale SA

B. Jonas, Wingham NSW

K Cardona, Moe VIC

K & D Hayes, Moura QLD

### DECENT 3

Q. How many 'Descent' games, including add-ons, have been released by Interplay?

A. Ten - Descent, Descent - Levels of the World, Descent - Mission Builder, Descent - FreeSpace: The Great War, Descent II, Descent II - The Infinite Abyss, Descent III, Descent Maximum (PSX), Descent Saturn, Forgotten Realms: Descent To Undermountain.

S. Gough, Hobart TAS

T. Gentle, Young NSW

G. Petchkovsky, Hazelbrook NSW

A. Ceppi, Wanniasa ACT

N. George, Newnham TAS

P. White, Woodford NSW

### REQUIEM

Q. List as many alternative names for the Devil as possible;

A. 666, Abaddon (Revelation 9:11), Accuser, Accuser of our Brethren (Revelation 12:10), Aduw Allah, Adversary (I Peter 5:8), Aeshma, Ageless Serpent, Ahriman (Egyptian), Ahrimanes, Andariel, Angel of the Abyss (Revelations 9:11), Angel of the Bottomless Pit (Revelations 9:11), Angra Mainyu, Anti-Christ, Apollyon (Revelation 9:11), Arch Demon, Arch-Enemy, Arch-Fiend, Asmodeus (Tob III 8-17), Astaroth, Auld Clootie, Auld Hornie, Auld Nick, Author of Evil, Azazel (Lord of the Wastelands), Azmodan, Baal (Hebrew), Balberith, Baphomet, Beast, Bezebul (Matthew 12:24, Mark 3:22, Luke 11:15), Bezebul (Matthew 12:24), Behemith, Beherit, Belial (I Corinthians 6:15), Belphegor, Bill Gates, Blue Angel, Cacodeamon, Calumniator, Carcan, Carrivean, Cloven Hoof, Common Enemy, Daemon, Daimonion, Daimonizomai, Daevas, Damned Spirit, Dark Lord, Dark Man, Dark One, Dark Prince, Death, Debil-Debil, Deceiver, Deified Spirit, Deil (Scottish), Demiurge, Demogorgon, Demon, Demonolater, Demonyo, Denizen of Hell, der Teufel, Destroyer, Deuce, Devil (Matthew 4:1), Devil Incarnate, Devil Whisperer, Devil's Spawn, Devildon, Devilkim, Diable (French), Diabolic Hierarchy, Diabolit, Diabolo, Diabolos Enemy Accuser (Greek), Diabolous, Dickens, Dievs, Dragon (Revelation 12:9 & 20:2), Dragon of Death, Dweller in Pandemonium, Dybbuk, Earl of Hell, Eblis, Enemy (Matthew 13:39), Erlik (Siberian God of the Underworld), Evil Genie, Evil One, Evil Spirit, Fallen Angel, Father of all Lies (John 8:44), Father of Evil, Fiend, Foul Fiend, Ghede (Voodoo God of Death), God of Ekron (Kings II 2:1), God of this World (II Corinthians 4:4), Great Dragon (Revelations 12:9), Gressil, GST (God's Satanic Torment), Ha-Satan, Haborym, Hel (Viking God(dess) of Niflheim), Hell-hound, His Satanic Majesty, Horned One, Hudas, Iblis (Muslim), Ictinike (Sioux Indian Version), Imp, Imp of Satan, Incubus, Inhabitant of Pandemonium, King of Babylon (Isaiah 14:4), King of Hell, King of Tyros (Ezekiel 28:12), Kroros, Leviathan, Lilith, Little Horn (Daniel 7:8), Loki, Lord of Evil, Lord of Light, Lord of Terror, Lord of the Flies, Lost Soul, Lucifer (Isaiah 14:12), Luvart, Magdalene, Mahy, Malevolent Spirit, Mammon, Man of Sin (II Thessalonians 2:3), Mara (Hindu/Buddist), Mastema, Mephisto, Mephistopheles (Faust), Mephistophes, Mephistophilis, Merihim, Microsoft, Mischief, Modo, Molach (Canaanite), Molech (Lev. XVIII 21:2), Moloch, Monarch of Hell, Mot (Canaanite), Mr Scratch, O-Yama, Old Gentleman, Old Gooseberry, Old Horny, Old Nick, Old Poker, Old Scratch, Old Serpent (Revelation 12:9 & 20:2), Oni (Japanese), Pisacha, Power of Darkness (Colossians 1:13), Prince of Darkness, Prince of Demons, Prince of Devils, Prince of Hell, Prince of Pandemonium, Prince of Shedium, Prince of the Air, Prince of the Power of the Air (Ephesians 2:2), Prince of this World (John 12:31), Prince of Tyros (Ezekiel 28:2), Prince that shall come (Daniel 9:26), Principle of Evil, Putana, Pwcca, Pytho, Rakil, Rashnu (Persian God of the Dead), Ravana, Rebel Angel, Red Dragon (Revelations 12:3), Rulers of the Darkness of this World (Ephesians 6:12), Sair, Sammael, Satan (Job 1:6), Satanael, Satanus, Schemer, Serpent (Genesis 3:1), Set, Seth, Shaitan, Shaytan, Sheitan, Shed, Shuitun, Sinner, Slanderer, Slibbertigibbet, Son of Perdition (John 17:12 & II Thessalonians 2:3), Sonneillon, Spirit of Evil, Spiritual Enemy of Mankind, Supreme Spirit of Evil, Tartarus, Tempter (Matthew 4:3), Tempter of Souls, Tiamal (Babylonian Version of Satan), Tutivillus, Typhon, Unclean Spirit, Verrine, Wicked One (Matthew 13:9), Xipetotec (Aztec God of Pain), Zamiel. (Please note - This is a complete list of all answers received. In other words - don't blame us for any mistakes or spelling errors).

D. Longworth, Cremorne NSW

C. Griffiths, White Gum Valley WA

K. Cox, Burreleigh Heads QLD

H. Dare-Edwards, Wagga Wagga NSW

M. Cooper, Clarmont TAS

K. Forcey, Mermaid Waters QLD

**FIM**  
WORLD CHAMPIONSHIPS

**500**  
GP

THE OFFICIAL  
FIM ROAD RACING CHAMPIONSHIP  
GRAND PRIX RACE SIMULATOR

# GP 500



You'll need something between your ears...



...to handle what's between your legs.

Real Speed, Real Teams, Real Bikes... Can you handle the power of the fastest accelerating and breaking machine in the world today? *GP500* lets you race the main event: the 500cc World Championship. Can you take it to the limit under pressure from the best riders in the world? It's about technique, knowing the track, knowing your opponents, understanding your 500cc powerhouse. Race against a sophisticated AI that incorporates real riders' styles and performance! You can almost feel rival racers breathing down your neck for each corner and straight! Change all bike set-ups to suit you. Take on Quick Race, Single Race, Championship Season and Multiplayer with 16 human players competing via Internet, LAN, Direct Connection and Modem.

**"This game gave me the biggest adrenaline rush I've ever had without hitting 180 mph on a real track."**

Kenny Roberts Jr. Team Suzuki



© 1999 Hasbro Interactive, Inc. All rights reserved.

**MICRO PROSE**

CD-ROM

**AUSTRALIA'S FAMOUS GAME**

# SQUATTER<sup>®</sup>

Experience the Australian Outback at home



## Features:

- Play up to 6 players or against the computer.
- Multiplayer on the Internet or networked.
- Actual video footage filmed on sheep stations.
- True to life challenges - fire, droughts, floods...

At last a game for the whole family to enjoy!

The Australian board game of skill, challenge and wits now on PC.



PC  
CD  
ROM  
WIN 95/98

TRU★BLU★  
ENTERTAINMENT



Distributed by: Home Entertainment Suppliers P/L, 126 Bonds Rd, Punchbowl NSW 2196.

AVAILABLE AT LEADING RETAILERS